

---

---

**FM 5-0**  
**(101-5)**

**Army**  
**Planning and Orders**  
**Production**

**Final Approved Draft**

**30 October 2004**

**HEADQUARTERS, DEPARTMENT OF THE ARMY**

**DISTRIBUTION RESTRICTION: Approved for public release; distribution is unlimited.**



# Army Planning and Orders Production

## Contents

	<b>Page</b>
	<b>PREFACE</b> .....iv
	<b>INTRODUCTION</b> .....vi
<b>Chapter 1</b>	<b>FUNDAMENTALS OF PLANNING</b> ..... 1-1
	The Nature of Planning ..... 1-1
	Key Planning Concepts ..... 1-14
	Digital Enhancements to Planning ..... 1-26
	Effective Planning ..... 1-27
<b>Chapter 2</b>	<b>ARMY PROBLEM SOLVING</b> .....2-1
	Problem Solving and Decision Making .....2-1
	Solving Problems in a Group Setting .....2-4
	Structure of Problems .....2-5
	Solving Problems .....2-5
<b>Chapter 3</b>	<b>THE MILITARY DECISION MAKING PROCESS</b> ..... 3-1
	Background ..... 3-1
	Performing the Military Decision Making Process.....3-11
	Planning in a Time-Constrained Environment ..... 3-53
<b>Chapter 4</b>	<b>TROOP LEADING PROCEDURES</b> .....4-1
	Troop Leading Procedures and the Military Decision Making Process .....4-1
	Performing Troop Leading Procedures.....4-4
<b>Appendix A</b>	<b>STAFF STUDIES AND DECISION PAPERS</b> .....A-1
	Staff Studies .....A-1
	Decision Papers .....A-7

**Distribution Restriction:** Approved for public release; distribution is unlimited.

\_\_\_\_\_  
\*When approved, this publication will supersede FM 101-5.

<b>Appendix B</b>	<b>MILITARY BRIEFINGS</b> .....	B-1
	Types of Briefings .....	B-1
	Briefing Steps .....	B-4
<b>Appendix C</b>	<b>STAFF GUIDELINES FOR MISSION ANALYSIS</b> .....	C-1
<b>Appendix D</b>	<b>COMMANDER’S GUIDANCE GUIDELINES</b> .....	D-1
<b>Appendix E</b>	<b>ESTIMATES</b> .....	E-1
<b>Appendix F</b>	<b>TASK ORGANIZATION</b> .....	F-1
	Fundamental Considerations .....	F-1
	Command and Support Relationships .....	F-3
	Task Organization Formats .....	F-7
<b>Appendix G</b>	<b>PLANS AND ORDERS</b> .....	G-1
	Characteristics .....	G-1
	Types of Plans .....	G-3
	Types of Orders .....	G-4
	Techniques for Issuing Orders .....	G-7
	Administrative Instructions for Preparing Plans and Orders .....	G-8
	Attachments (Annexes, Appendixes, Tabs, and Enclosures) .....	G-12
	Standing Operating Procedures .....	G-13
	Matrices and Templates .....	G-14
	Examples and Procedures for Completing Plans, Orders, and Annexes .....	G-16
	List of Figures .....	G-17
<b>Appendix H</b>	<b>INTEGRATING TARGETING INTO THE OPERATIONS PROCESS</b> .....	H-1
	Targeting Process and Targeting Team .....	H-1
	Decide .....	H-2
	Detect .....	H-6
	Deliver .....	H-7
	Assess .....	H-7
<b>Appendix I</b>	<b>JOINT PLANNING</b> .....	I-1
	Joint Planning Overview .....	I-1
	Joint Planning Concepts .....	I-2
	Joint Operation Plan Format .....	I-4

<b>GLOSSARY</b> .....	Glossary-1
<b>BIBLIOGRAPHY</b> .....	Bibliography-1
<b>INDEX</b> .....	Index-1



## **Preface**

Doctrine provides a military organization with unity of effort and a common philosophy, language, and purpose. FM 5-0 is the Army's keystone manual for planning operations. It is the Army's doctrinal source for problem solving, the military decision making process (MDMP), troop leading procedures (TLP), and formats for Army plans and orders.

### **PURPOSE**

FM 5-0 promotes a common understanding of the fundamentals of planning and provides the foundation for developing tactics, techniques, and procedures (TTP) for planning in all Army publications. It provides a doctrinal approach to decision making that helps commanders and their staffs examine a situation, reach logical conclusions, and make informed decisions. FM 5-0 is the common reference for planning within the Army education system.

### **SCOPE**

FM 5-0 includes MDMP and formats for plans, orders, and briefings formerly found in FM 101-5. Staff responsibilities, staff officer duties during preparation for and execution of operations, rehearsals, information management, and liaison duties formerly addressed in FM 101-5, are now covered in FM 6-0.

Chapter 1 describes the Army's approach to planning and discusses the nature of plans and planning activities. Chapter 2 discusses Army problem solving in general terms and prescribes the steps of the Army problem solving process. Chapter 3 explains the MDMP. Chapter 4 discusses TLP. The appendixes are planning tools to assist commanders and staffs in planning, decision making, orders production, and military briefings.

### **APPLICABILITY**

FM 5-0 applies to all Army leaders. Chapters 1 and 2 contain doctrine and TTP that apply to planning and solving problems at all echelons throughout the institutional and field Army. The primary audience for Chapter 3 is battalion-through corps-level commanders, leaders, and staffs. Chapter 4 applies to leaders and Soldiers at company-level and below. The appendixes support Chapters 2 through 4.

Doctrine in FM 5-0 applies across the spectrum of conflict (peacetime military engagement, smaller-scale contingencies, and major theater war), and the range of operations (offense, defense, stability, and support). FM 5-0 does not detail tactical missions or the use of forces during operations. The examples provided are guides only, showing general application procedures.

Army headquarters serving as the headquarters of a joint force land component or joint task force should refer to JP 5-0 and other joint planning publications. Additionally, Army service component commands, and headquarters serving as

ARFOR headquarters, should also refer to FM 100-7 for Army-specific, operational-level planning considerations.

### ADMINISTRATIVE INFORMATION

Terms that have joint or Army definitions are identified in both the glossary and the text. The glossary lists most terms used in FM 5-0 that have joint or Army definitions. Terms for which FM 5-0 is the proponent manual (the authority) are indicated with an asterisk in the glossary. Definitions for which FM 5-0 is the proponent manual are printed in boldface in the text. These terms and their definitions will be incorporated into the next revision of FM 1-02. For other definitions in the text, the term is italicized and the number of the proponent manual follows the definition.

The glossary contains referents of acronyms and definitions of terms not defined in JP 1-02 and FM 1-02. Some common abbreviations and acronyms—for example, the abbreviations for military ranks and publications—are not spelled out; refer to the glossary. Additionally, since *ARFOR* is a defined term as well as an acronym, it is not spelled out.

All references to annexes refer to annexes to operation plans (OPLANs) or operation orders (OPORDs) unless stated otherwise.

Unless stated otherwise, masculine nouns or pronouns do not refer exclusively to men.

Headquarters, US Army Training and Doctrine Command, is the proponent for this publication. The preparing agency is the Army Doctrine Proponency Division, US Army Combined Arms Center. Send written comments and recommendations on DA Form 2028 (Recommended Changes to Publications and Blank Forms) directly to Commander, US Army Combined Arms Center and Fort Leavenworth, ATTN: ATZL-CD (FM 5-0), 1 Reynolds Road (Building 111), Fort Leavenworth, KS 66027-1352. Send comments and recommendations by e-mail to [web-cadd@leavenworth.army.mil](mailto:web-cadd@leavenworth.army.mil). Follow the DA Form 2028 format or submit an electronic DA Form 2028.



## Introduction

Modern military staff procedures can be traced back to the formation of the Prussian general staff under General Helmuth von Moltke in the late nineteenth century. As warfare became more complex, doctrine on planning and decision making evolved in an effort to help commanders make decisions better and faster than their opponents. While the beginning of a modern staff system in the US Army emerged during the American Civil War (1861-1865), doctrine regarding staff procedures, decision making, and planning was limited until World War I.

Not until the 1924 publication of *Field Service Regulations* did Army doctrine show formatted orders with annexes, maps, and tables. Even then, doctrine only alluded to the requirement for leaders to make an “estimate of the situation” and follow a deliberate process that culminated in a decision.

In 1932, the first manual for staff officers was published under authority of General (later General of the Army) Douglas MacArthur. The 1932 *Staff Officer’s Field Manual* provided the US Army’s first comprehensive command and staff doctrine on which today’s staff procedures are based. The 1932 manual described staff functions, explained a five-step commander’s estimate process, and provided detailed formats for operation orders.

In August 1940, the first FM 101-5—*Staff Officer’s Field Manual, The Staff and Combat Orders*—was published. The doctrine established was broader in scope and depth than that of the 1932 manual. It defined terms and standardized graphics, and discussed commander and staff responsibilities more precisely. It guided Army commanders and staffs throughout World War II and for almost five years thereafter.

FM 101-5 was revised five times between 1940 and 1984. In May 1997, 13 years after its last revision, FM 101-5, then titled *Staff Organization and Operations*, was republished. It focused on command and staff relationships, staff organizations, staff officer responsibilities, the military decision making process, and the mechanics of producing orders. Additionally, it added doctrine on information management and two central concepts of Army command and control (C2) doctrine: the commander’s intent and commander’s critical information requirements (CCIR).

FM 5-0 marks the sixth revision of FM 101-5 since it was first published. Together, FM 5-0 and FM 6-0, replace FM 101-5. FM 5-0 now addresses only planning. FM 6-0 addresses C2, staff organization and operations, the duties of and relationship between the commander and staff, information management, rehearsals, and liaison. This organization mirrors a similar distinction made in joint doctrine.

The doctrine FM 5-0 prescribes is built on two central precepts: (1) commanders are responsible for planning and (2) effective planning incorporates the concept of mission command.

*Commanders are responsible for planning.* Their knowledge, experience, and personality—along with how they interact with their staff and units—drives the

planning process. While staffs complete much of the detailed analysis and preparations of plans and orders, commanders play a central role in planning through their commander's intent, CCIR, and planning guidance. These guide the activities of the staff and subordinate commanders. Staffs assist commanders with the coordination and detailed analysis necessary to convert the commander's intent, CCIR, and planning guidance into a plan or order.

*Effective planning incorporates the concept of mission command.* Mission command, the Army's preferred C2 concept, concentrates on the objective of an operation and not on every detail of how to achieve that objective (see FM 6-0). Successful mission command results in subordinate leaders at all echelons exercising disciplined initiative within the commander's intent. Staffs support mission command when they produce mission orders. *Mission orders* is a technique for completing combat orders. This allows subordinates maximum freedom of planning and action to accomplish missions and leaves the "how" of mission accomplishment to the subordinates (FM 6-0). FM 5-0 applies this technique to planning and describes how to produce mission orders.

To understand FM 5-0, readers must understand the fundamentals of full spectrum operations described in FM 3-0 and the art of tactics described in FM 3-90. They must discern how the activities described in FM 3-07 carry over and affect offensive and defensive operations. They must recognize the operations process (plan, prepare, execute, and assess) described in FM 6-0, and understand how mission command, commander's visualization, and exercising C2 influence planning. FM 5-0 also refers to joint publications. Reviewing these joint publications stimulates understanding of how Army planning supports and complements joint planning.

Many of the examples provided are based on offensive and defensive operations. Tactical planning for stability operations and support operations is performed in a similar manner to offensive and defensive operations. However, applying combat power in offensive and defensive operations is different than in stability operations and support operations. Planning horizons may be longer and the emphasis on civil considerations greater. FM 3-07 provides planning considerations for stability and support operations.

FM 5-0 expands Army planning doctrine. To plan effectively, planners and commanders must appreciate the nature of planning and plans. Planners must understand the purpose, environment, and characteristics of the planning process. Knowledge of FM 5-0 forms the basis for this understanding.

# Chapter 1

## Fundamentals of Planning

*Successful generals make plans to fit circumstances, but do not try to create circumstances to fit plans.*

General George S. Patton Jr.

This chapter provides an overview of the nature of planning. It describes how planning is part of the broader field of command and control (C2) and an essential activity of the operations process. It emphasizes mission command as the preferred C2 concept for planning operations in uncertain and fluid environments. It describes how planning supports decision making and includes the fundamentals of planning. This chapter also provides key planning concepts, to include how time, uncertainty, and risk influence planning. It describes effective planning and discusses the pitfalls that commonly impede it. Finally, this chapter addresses how modern information systems enhance planning.

### NATURE OF PLANNING

1-1. Military operations are uncertain and unpredictable. They are complex endeavors—struggles between opposing human wills. Commanders face thinking and adaptive enemies. They can never predict with certainty how enemies will act and react, or how events will develop. Even friendly actions are difficult to predict because of friction, such as human mistakes and the effects of stress on individuals. Leaders who understand the dynamic relationship that time and uncertainty have on enemy and friendly forces are better equipped to develop effective plans. Given the nature of operations, the object of planning is not to eliminate uncertainty but to develop a framework for action in the midst of it.

<b>CONTENTS</b>	
<b>Nature of Planning</b> ..... 1-1 <b>Science and Art of Planning</b> ..... 1-3 <b>Planning as Part of</b> <b>Command and Control</b> ..... 1-4 <b>Planning and Decision Making</b> ..... <b>Operational-Level and Tactical-Level</b> <b>Planning</b> ..... 1-7 <b>Fundamentals of Planning</b> ..... 1-8 <b>Functions of Planning and Plans</b> ..... 1-12 <b>Key Planning Concepts</b> ..... 1-14 <b>Nested Concepts</b> ..... 1-15 <b>Sequencing Operations</b> ..... 1-16	<b>Control Measures</b> ..... 1-18 <b>Risk Reduction</b> ..... 1-18 <b>Hasty and Deliberate Operations</b> 1-19 <b>Intelligence, Surveillance, and</b> <b>Reconnaissance</b> ..... 1-20 <b>Planning Horizons</b> ..... 1-20 <b>Parallel and Collaborative Planning</b> ... 1-22 <b>Forward and Reverse Planning</b> ..... 1-23 <b>One-Third/Two-Thirds Rule</b> ..... 1-23 <b>Planning Pitfalls</b> ..... 1-24 <b>Digital Enhancements to Planning</b> ..... 1-26 <b>Effective Planning</b> ..... 1-27

1-2. *Planning* is the means by which the commander envisions a desired outcome, lays out effective ways of achieving it, and communicates to his subordinates his vision, intent, and decisions, focusing on the results he expects to achieve (FM 3-0). The outcome of planning is a plan or an order that—

- Fosters mission command by clearly conveying the commander’s intent.
- Assigns tasks and purposes to subordinates.
- Contains the minimum coordinating measures necessary to synchronize the operation.
- Allocates or reallocates resources.
- Directs preparation activities and establishes times or conditions for execution.

1-3. A plan is a continuous, evolving framework of anticipated actions that maximize opportunities and guide subordinates through each phase of the operation. A plan may be a formal, articulated document or an informal scheme. Since planning is an ongoing process, a plan is an interim product of planning based on information and understanding at the moment that is subject to revision. The measure of a good plan is not whether execution transpires as planned but whether the plan facilitates effective action in the face of unforeseen events.

*Any plan is a framework from which to adapt, not a script to be followed to the letter.*

FM 3-0

1-4. Full spectrum operations demand a flexible approach to planning that adapts planning methods to each situation. An effective planning process structures the thinking of commanders and staffs while supporting their insight, creativity, and initiative. The Army uses three different, but related processes to guide planning activities:

- Army problem solving.
- The military decision making process (MDMP).
- Troop leading procedures (TLP).

1-5. Army problem solving provides a standard, systematic approach to define and analyze a problem, develop and analyze possible solutions, choose the best solution, and implement a plan of action that solves the problem (see Chapter 2). Problem solving applies to all Army activities and provides the base logic for the Army’s two tactical planning processes: MDMP and TLP. The MDMP is more appropriate for headquarters with staffs. It provides a logical sequence of decisions and interactions between the commander and staff for developing estimates and effective plans and orders (see Chapter 3). At lower tactical echelons, commanders do not have staffs. Leaders at company level and below use TLP to plan and prepare for an operation (see Chapter 4).

**SCIENCE AND ART OF PLANNING**

1-6. Planning is both science and art. For example, many aspects of military operations are quantifiable such as, movement rates, fuel consumption, and weapons effects. They are part of the science of planning. Other aspects belong to the art of planning. The combination of forces, choice of tactics, and arrangement of activities, for example, belong to the art of planning. Knowledge of the science of planning is often gained through institutional training and study. Understanding the art of planning is primarily gained through operational training and experience. Effective planners understand and master both the science and the art of planning.

**Science of Planning**

1-7. The science of planning encompasses aspects of operations—capabilities, techniques, and procedures—that can be measured and analyzed. These include the physical capabilities of friendly and enemy organizations and systems. It includes a realistic appreciation for time-distance factors and an understanding of how long it takes to initiate certain actions. The science of planning includes the tactics, techniques and procedures (TTP) used to accomplish planning tasks and the operational terms and graphics that compose the language of tactics. While not easy, the science of planning is straightforward.

1-8. Planners master the science aspect of military operations to understand the physical and procedural constraints under which units operate. Because military operations are an intensely human activity, planning cannot be reduced to a formula. This fact necessitates understanding the art of planning.

**Art of Planning**

1-9. The art of planning requires understanding how the dynamic relationships between friendly forces, adversaries, and the environment create complexity within operations. This understanding helps planners develop simple

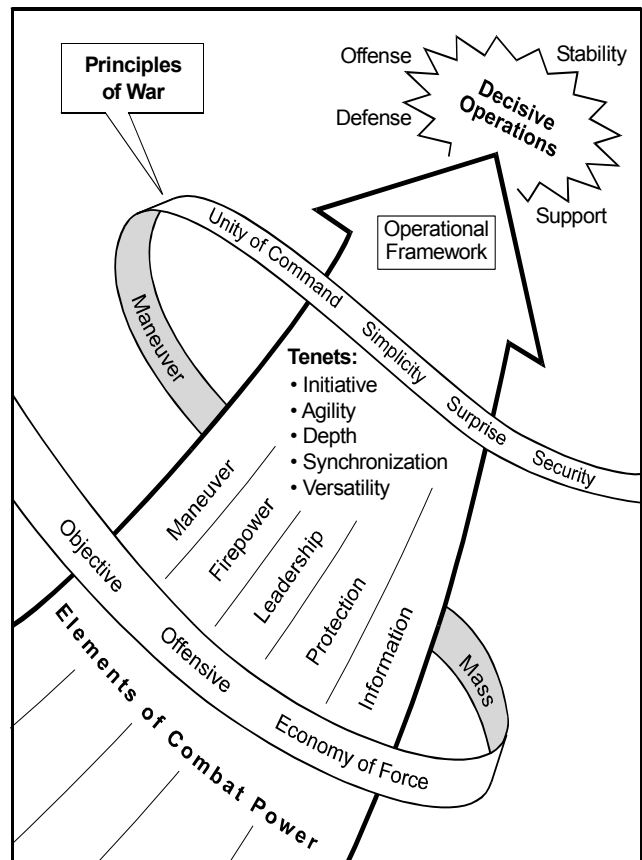

**Figure 1-1. Fundamentals of Full Spectrum Operations**

and flexible plans for a variety of circumstances. The art of planning includes knowing the effects of operations on soldiers. It involves the commander's willingness to take calculated risks.

1-10. Planning requires creative application of doctrine, TTP, units, and resources. It requires a thorough knowledge and application of the fundamentals of full spectrum operations (see Figure 1-1 and FM 3-0) and the art of tactics (see FM 3-90). The art of planning involves developing plans within the commander's intent and planning guidance by choosing from interrelated options, including—

- Types and forms of operations, forms of maneuver, and tactical mission tasks.
- Task organization of available forces.
- Arrangement of activities in time, space, and purpose.
- Resource allocation.
- Choice and arrangement of control measures.
- Tempo.
- Risk the commander is willing to take.

1-11. These options define a starting point from which planners create distinct solutions to particular tactical problems. Each solution involves a range of options. Each balances competing demands and requires judgment. The factors of mission, enemy, terrain and weather, troops and support available, time available, civil considerations (METT-TC) always combine to form a different set of circumstances. There are no checklists that adequately apply to every situation.

## PLANNING AS PART OF COMMAND AND CONTROL

1-12. Planning is part of the extended field of command and control. FM 6-0 describes two C2 concepts, detailed command and mission command. While the Army's preferred C2 concept is mission command, commanders do not rely on purely detailed or purely mission command techniques. The degree to which planners incorporate detailed command techniques into plans and orders depends primarily on the nature of the action or task, qualities of the staff and subordinates commanders, and the capabilities of the enemy.

### Detailed Command

1-13. Detailed command centralizes information and decision making authority. Orders and plans are detailed and explicit. Successful execution depends on strict compliance to the plan with minimal decision making and initiative by subordinates. Detailed command emphasizes vertical, linear information flow; information flows up the chain of command and orders flow down. It stems from the belief that imposing order and certainty on the battlefield brings successful results. In detailed command, commanders command by personal direction or detailed directive.

1-14. In detailed command, commanders impose discipline and coordination from above to ensure compliance with all aspects of the plan. Detailed orders may achieve a high degree of coordination in planning, however, after the operation has commenced, it leaves little room for adjustment by

subordinates without reference to higher headquarters. Detailed command is not suited for taking advantage of a rapidly changing situation. It does not work well when the chain of command and information flow is disrupted. Detailed command is less effective in fluid military operations requiring judgment, creativity, and initiative. Because of these disadvantages, mission command is the Army's approved technique.

## Mission Command

1-15. *Mission command* is the conduct of military operations through decentralized execution based on mission orders for effective mission accomplishment. Successful mission command results from subordinate leaders at all echelons exercising disciplined initiative within the commander's intent to accomplish missions. It requires an environment of trust and mutual understanding (FM 6-0). Mission command is the preferred C2 concept for planning. It emphasizes timely decision making, subordinates understanding of the commander's intent, and the clear responsibility of subordinates to exercise initiative within that intent.

1-16. Mission command accepts the uncertainty of operations by reducing the amount of certainty needed to act. In such a philosophy, commanders hold a "loose rein," allowing subordinates freedom of action and requiring initiative on their part. Commanders make fewer decisions, allowing them to focus decision making on the most important ones. Mission command tends to be decentralized, informal, and flexible. Orders and plans are as brief and simple as possible. Commanders rely on subordinates' coordination ability and the human capacity to understand with minimum verbal information exchange. The elements of mission command are—

- The commander's intent.
- Subordinates' initiative.
- Mission orders.
- Resource allocation.

1-17. Effective planning supports mission command by stressing the importance of *mission orders*—a technique for completing combat orders that allows subordinates maximum freedom of planning and action in accomplishing missions and leaves the "how" of mission accomplishment to subordinates (FM 6-0). Mission orders state the task organization, commander's intent and concept of operations, unit mission, subordinates' missions, and the essential coordinating instructions. Missions assigned to subordinates include all normal elements (who, what, when, where, and why). However, they place particular emphasis on the purpose (why) in order to guide, along with the commander's intent, subordinates' initiative.

1-18. Mission command requires plans with the proper level of detail; not so detailed that they stifle initiative or so general that they provide insufficient direction. The proper level depends on each situation and is not easy to determine. Some operations require tighter control over subordinate elements than others. An air assault or a river crossing operation, for example, requires precise synchronization. In these examples, plans or portions of the plan are more thorough. As a rule, plans should only contain specific information required to provide the guidance necessary to

synchronize combat power at the decisive time and place while allowing subordinates as much freedom of action as possible.

## PLANNING AND DECISION MAKING

1-19. *Decision making* is selecting a course of action as the one most favorable to accomplish the mission (FM 6-0). Planning is a form of decision making. However, not all decisions require the same level of planning. Commanders make hundreds of decisions during operations in an environment of great uncertainty, unpredictability, and constant change. Some decisions are deliberate, using the MDMP and a complete staff to create a fully developed and written order. The commander makes other decisions very quickly. This results in a fragmentary order (FRAGO). When developing plans, commanders normally choose between analytic or intuitive means of decision making.

### Analytic Decision Making

1-20. Analytic decision making approaches a problem systematically. Leaders analyze a problem, generate several possible solutions, analyze and compare them to a set of criteria, and select the best solution. The analytic approach aims to produce the optimal solution to a problem from among those solutions identified. This approach is methodical, and it serves well for decision making in complex or unfamiliar situations by allowing the breakdown of tasks into recognizable elements. It ensures that the commander and staff consider, analyze, and evaluate all relevant factors. It may help inexperienced leaders by giving them a methodology to compensate for their lack of experience. The Army's analytical approach to decision making is Army problem solving (see Chapter 2) and the MDMP (see Chapter 3).

1-21. The analytic approach to decision making serves well when time is available to analyze all facets affecting the problem and its solution. However, analytic decision making consumes time and does not work well in all situations—especially during execution, where circumstances often require immediate decisions.

### Intuitive Decision Making

1-22. *Intuitive decision making* is the act of reaching a conclusion that emphasizes pattern recognition based on knowledge, judgment, experience, education, intelligence, boldness, perception, and character. This approach focuses on assessment of the situation vice comparison of multiple options (FM 6-0). It is used when time is short or speed of decision is important. Intuitive decision making is faster than analytic decision making in that it involves making decisions based on an assessment of the situation rather than a comparison of multiple COAs. It relies on the experienced leader's ability to recognize the key elements and implications of a particular problem or situation, reject the impractical, and select an adequate (rather than the optimal) COA.

1-23. Intuitive decision making is especially appropriate in time-constrained conditions. It significantly speeds up decision making. Intuitive decision



making, however, does not work well when the situation includes inexperienced leaders, complex or unfamiliar situations, or competing COAs. Additionally, substituting assessment for detailed analysis means that some implications may be overlooked. Commanders use intuitive decision making when time is short and problems straightforward. It is usually appropriate during execution (see FM 6-0).

### **Combining Analytic and Intuitive Decision Making**

1-24. The two approaches to decision making are rarely mutually exclusive. Commanders often base an intuitive decision during execution on the situational understanding and products generated as part of a preceding MDMP. The staff may use part of the MDMP, such as war-gaming, to verify or refine a commander's intuitive decision if time permits. When commanders direct the MDMP in a time-constrained environment, many of the techniques, such as choosing only one COA, depend on intuitive decisions. Even in the most rigorous analytic decision making, intuitive decision making helps set boundaries for the analysis and fills in the gaps that remain.

1-25. Each method of decision making has strengths and weaknesses. Selecting one over the other depends primarily on the experience of the commander and staff, and how much time and information are available. The analytic approach is more appropriate when enough time and information are available to choose among different COAs, or when the staff is inexperienced. The majority of tactical decisions made during execution, when time is short and information is lacking or doubtful, are intuitive.

### **OPERATIONAL-LEVEL AND TACTICAL-LEVEL PLANNING**

1-26. It is important to understand planning within the context of the levels of war. The levels of war are doctrinal perspectives that clarify the links between strategic objectives and tactical actions (see FM 3-0). The three levels are strategic, operational, and tactical, although there are no distinct limits or boundaries between them. The strategic and operational levels provide the context for tactical operations.

1-27. Operational- and tactical-level planning complements each other but have different aims. Operational-level planning focuses on developing plans for campaigns and major operations. Planners at the operational level focus on operational art—the use of military forces to achieve strategic goals through the design, or organization, integration, and conduct of theater strategies, campaigns, major operations, and battles. Operational-level plans link the tactical employment of forces to strategic objectives.

1-28. Tactical-level planning revolves around battles and engagements conducted to accomplish military objectives assigned to tactical units (see FM 3-90). Activities at this level focus on tactics. *Tactics* is the employment of units in combat. It includes the ordered arrangement and maneuver of units in relation to each other, the terrain, and the enemy to translate potential combat power into victorious battles and engagements (FM 3-90). Tactical-level planning emphasizes flexibility and options. Planning horizons (see paragraphs 1-85–1-89) for tactical actions are relatively short. At the tactical

level, comprehensive planning may be feasible only for the first engagement or phase of a battle; succeeding actions could depend on enemy responses and circumstances. A key to effective tactical planning lies in anticipating and developing sound branches and sequels.

1-29. Operational-level planning involves broader dimensions of time and space than tactical-level planning. It is often more complex and less defined. Operational-level planners are often required to define an area of operations (AO), estimate forces required, and evaluate the requirements for the operation. In contrast, tactical-level planning proceeds from an existing operational design. Normally AOs are prescribed, objectives and available forces identified, and sequences of activities specified for tactical-level commanders. Operational- and tactical-level planning, however, are not limited to particular echelons. Major Army Command (MACOM) headquarters may engage in tactical planning, and echelons normally associated with tactical missions increasingly find themselves undertaking operational-level design.

1-30. The joint operation planning process (deliberate, crisis action, and campaign) is beyond the scope of this manual. However, Army forces operate in a joint environment, and Army leaders must understand joint operation planning. Army service component commands (ASCCs) routinely participate in joint operation planning including planning for the joint force land component. Corps and divisions perform or participate in joint operation planning when serving as joint task force (JTF) or ARFOR headquarters. Appendix I summarizes joint operations planning and provides a joint formatted order as a quick reference for Army planners. JP 5-0 covers joint operation planning in detail. Additionally, FM 100-7 outlines Army operational- level planning considerations.

## FUNDAMENTALS OF PLANNING

1-31. Combat consists of the interplay between two or more opposing commanders—each commander seeking to accomplish their missions while preventing the other from doing the same. Every commander needs a high degree of creativity and clarity of thought to outwit a willing and able opponent. Commanders and staffs

### Fundamentals of Planning

- Commanders focus planning.
- Planning is continuous.
- Planning is time sensitive.
- Keep plans simple.
- Build flexible plans.
- Design bold plans.

consider certain planning fundamentals to assist them in developing effective plans. These fundamentals lend rigor and focus to the purely creative aspect of planning and provide a crucial link between concept and application. The degree of their application varies with the situation.

### Commanders Focus Planning

1-32. The commander is the most important participant in effective planning. Commanders discipline the planning process to meet the requirements of time, planning horizons, simplicity, and level of detail. Commanders ensure that all operation plans and orders are compliant with domestic and international law. They also confirm the product to ensure it is

relevant and suitable for subordinates. Generally, the more involved commanders are in planning, the faster staffs can plan. Through personal involvement, commanders ensure their commander's intent is reflected in the plan.

1-33. Commanders, assisted by their staff, use the activities of visualizing the battlespace, describing the visualization to subordinates, directing action in terms of the battlefield operating systems (BOS) to achieve results, and leading the unit to mission accomplishment (see FM 3-0 and FM 6-0).

1-34. *Commander's visualization* is the mental process of achieving a clear understanding of the force's current state with relation to the enemy and environment (situational understanding), and developing a desired end state that represents mission accomplishment and the key tasks that move the force from its current state to the end state (commander's intent) (FM 6-0). Commander's visualization (see Figure 1-2) is a way of mentally viewing the dynamic relationship among Army forces, enemy forces, and the environment at the present while conducting operations against an opposing force over time.

1-35. Commander's visualization commences in planning and continues throughout the operations process until the force accomplishes its mission. Commanders describe their visualization, in the form of their commander's intent, planning guidance, and commander's critical information requirements (CCIR). Chapter 3 provides a detailed discussion of the commander's role in planning, including the commander's intent, planning guidance, and CCIR.

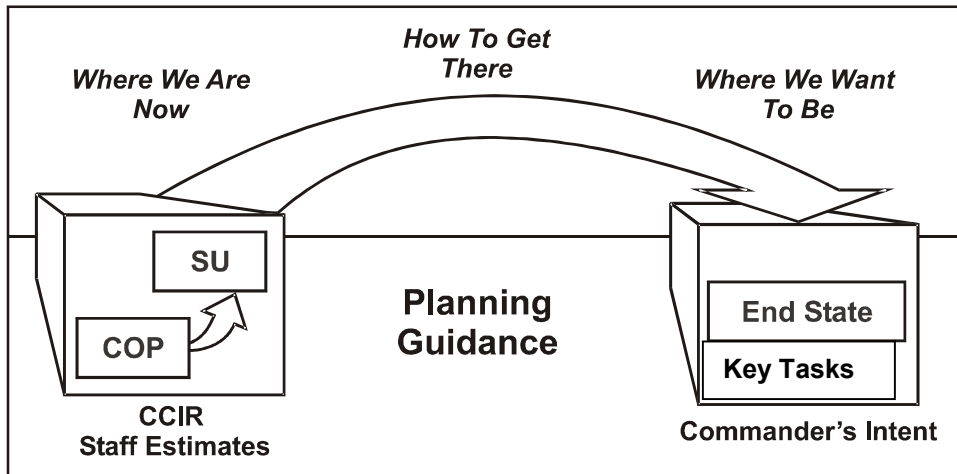

Figure 1-2. Commander's Visualization

**Planning Is Continuous**

1-36. Planning does not stop with the production of an order. It is a continuous and adaptive process. Since situations (or the information available about them) continuously change, plans are revised as time allows.

Accurately predicting an operation’s outcome is difficult. Anticipating the many possible contingencies, especially those far in the future is more difficult. As planners develop a solution to a problem, the problem changes. Continuous planning enables organizations to adjust from an existing concept of operations based on a common understanding of the situation and the expected result.

1-37. Because plans concern future operations that help the commander and staff make assumptions about the nature of the situation at the time of execution, plans cannot remain static. As the commander and staff adjust their estimates, they also change their plans. A plan, even if not executed as designed, provides the point of departure for later unplanned actions.

1-38. Planning occurs throughout the operations process (see Figure 1-3). During preparation, plans are revised based on new information. Feedback from unit backbriefs and rehearsals may also initiate changes to the plan. During execution, plans are revised based on the assessed progress of the operation and new information. Anticipated branches and sequels, initially formulated during the planning stage, are assessed and updated for possible execution. Anytime during the operations process, unanticipated threats or opportunities may significantly change the situation, requiring the planning process to restart and a new plan developed. Continuous assessment, reflected in staff running estimates, is key to ensuring plans are revised and remain relevant to the situation. (Appendix E discusses staff estimates.)

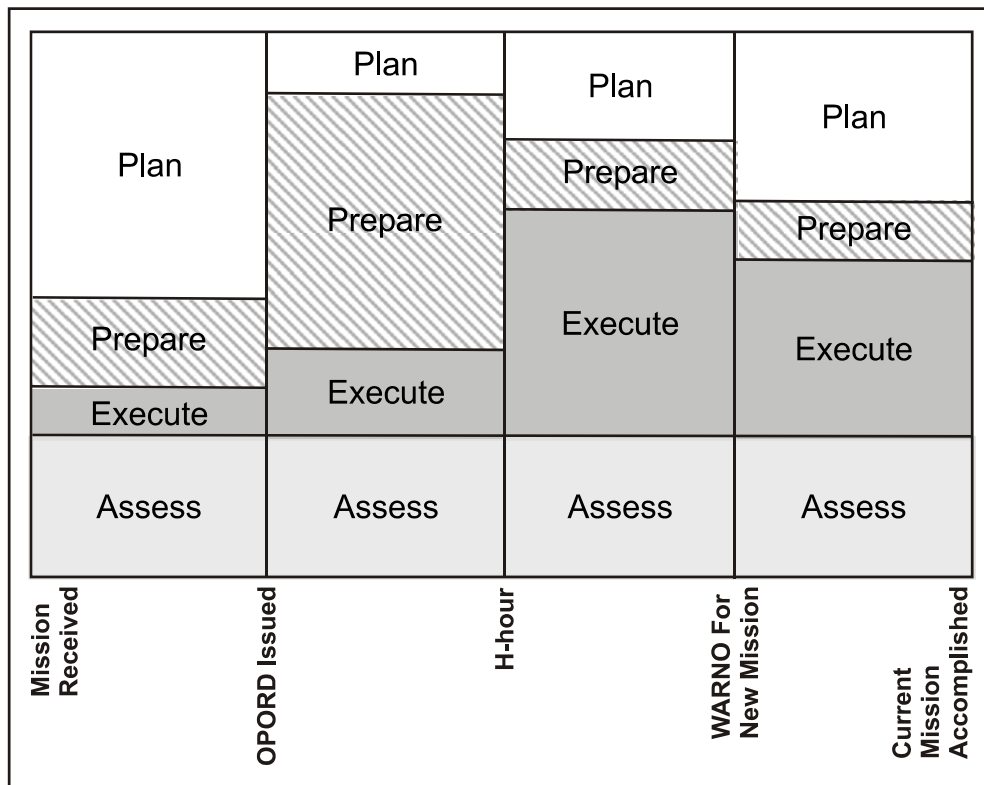

Figure 1-3. Distributions of Operations Process Activities

### **Planning Is Time Sensitive**

1-39. Time is a critical factor in planning. Whether done deliberately or rapidly, all planning requires accurate situational understanding and skillful use of time. Time is a precious commodity during operations that both sides (friendly and enemy) attempt to exploit. The result is a constant pressure to decide and act quicker than the enemy. Understanding the effects of time on conducting (planning, preparing, executing, and continuously assessing) operations helps commanders determine how fast and how far ahead to plan. Taking more time to plan often results in greater synchronization; however, it also means less time for subordinates to plan and prepare, and more time for the enemy to prepare and act.

1-40. When allocating planning time, commanders consider subordinates' planning requirements. Commanders ensure that plans are sent to subordinates in enough time to allow them to adequately plan and prepare their own actions. When time is short, commanders do not demand perfect products. They accept the best possible products. In time-constrained environments, "best products" are those that contain just enough information to make a reasoned decision and give subordinates time to quickly assess the situation from their perspective and plan, prepare, and execute the necessary actions. Commanders use parallel and collaborative planning techniques to give subordinate units maximum planning and preparation time (see paragraphs 1-90–1-95).

### **Keep Plans Simple**

1-41. Simplicity is a principle of war; it is key to effective planning. Effective plans and orders are simple and direct. Staffs prepare clear, concise orders to ensure thorough understanding. They use doctrinally correct operational terms and graphics, and eliminate opportunities to misunderstand the commander's intent.

1-42. Simple plans require an easily understood concept of operations. Planners prepare these plans by limiting the number of actions or tasks to the minimum the situation requires. They minimize details where possible, allowing subordinates to develop specifics within the commander's intent. For example, instead of assigning a direction of attack, planners can designate an axis of advance.

1-43. Simple plans are not simplistic plans. Simplistic refers to something made overly simple by ignoring the complexity of the situation. The factors of METT-TC determine the degree of simplicity possible. Good plans simplify complex situations; however, some situations require more complex plans than others. Commanders at all levels weigh the apparent benefits of a complex concept of operations against the risk that subordinates will not be able to understand or follow it. Simple plans are preferred because they are easier to understand and execute.

### **Build Flexible Plans**

1-44. Flexible plans allow units to adapt quickly to a variety of circumstances. Commanders and planners build opportunities for initiative into plans by anticipating events that allow them to operate inside of the

enemy's decision making cycle during execution. Identifying decision points and designing branches and sequels ahead of time—combined with a clear commander's intent—aids in building flexible plans. Incorporating risk reduction measures into a plan also builds flexibility. For example, a commander may plan a large mobile reserve to compensate for the lack of information concerning an anticipated enemy attack.

1-45. Commanders stress the importance of mission orders as a way of building flexible plans. Mission orders focus on what to do and the purpose, without prescribing exactly how to do it. Control measures are established to aid cooperation among forces without imposing needless restrictions on freedom of action. This allows subordinates maximum freedom to make their own plans to accomplish the mission. Mission orders contribute to flexibility by allowing subordinates freedom to seize opportunities or react effectively to unforeseen enemy actions and capabilities.

### **Design Bold Plans**

1-46. Commanders design bold, innovative plans that produce decisive results. Bold plans go beyond the usual limits of conventional thought or action to mass the effects of overwhelming combat power at the decisive place and time. Bold plans are not rash plans—plans developed hastily without due consideration to the situation. Commanders must understand when and where to take calculated risks. (FM 3-90 and FM 6-0 discuss military risk and military gamble). Through their commander's intent and planning guidance, commanders build offensive action into all plans. Commanders design bold plans that allow them to initiate combat on their own terms and seize, retain, and exploit the initiative.

## **FUNCTIONS OF PLANNING AND PLANS**

1-47. Planning and plans accomplish several key functions. When the problem is simple, detailed planning may not be necessary. When the problem is complicated, planning is essential. Planning, however, is not an end in itself. Using a prescribed planning process does not guarantee an organization will improve its situation. Mastering the procedural aspects of planning is important; however, creative thinking and applying sound judgment to solve tactical problems is the foundation of effective planning. Planning takes on value when performed properly using methods appropriate to the conditions and activities being planned. Accomplished properly, planning greatly improves performance.

1-48. Planning and plans help the commander and staff—

- Think critically.
- Develop situational understanding.
- Anticipate decisions.
- Simplify complexity.
- Task-organize forces and allocate resources.
- Direct and coordinate actions.
- Guide preparation activities.

### **Planning Helps Leaders Think Critically**

1-49. The Army's doctrinal planning processes (problem solving, MDMP, and TLP) are based on analytic decision making. They provide a common way to think about solving problems. When faced with a problem or tactical mission, Army leaders define the problem; gather information relevant to it; develop, analyze, and compare COAs; and select the optimal solution. The MDMP provides a standard organized framework for commanders and staffs to approach and solve tactical problems. Using common processes, understood Army-wide, helps commanders standardize planning techniques. Standard techniques facilitate effective planning between echelons and with cross-attached and adjacent units.

### **Planning Builds Situational Understanding**

1-50. Planning that analyzes the factors of METT-TC helps commanders and staffs understand the current state of enemy and friendly forces in relation to the environment and each other. This analysis contributes to developing situational understanding and providing a common understanding of the nature of the problem among the commander, staff, and subordinates. In turn, commanders can better visualize and describe an operation to the staff and subordinate commanders. A common understanding of the situation supports communication and cooperation among commanders, staffs, and subordinates during planning. It provides the basis for unity of effort and the exercise of subordinates' initiative during execution. The situational understanding and products developed during planning provide the context for adjusting and revising the plan during execution.

### **Planning Helps Leaders Anticipate**

1-51. Anticipatory planning is essential to seizing and retaining the initiative. It involves projecting thoughts forward in time and space to determine how to influence events before they occur, rather than responding to events dictated by others. To seize the initiative, commanders must anticipate events and act purposefully and effectively before enemies do starting with the initial commander's visualization.

1-52. Effective planning allows commanders and staffs to consider potential decisions and actions in advance by developing decision points, branches, and sequels (see paragraphs 1-66 through 1-68). While the base plan serves as a guide during execution, planners continue to develop or refine courses of action for unexpected enemy action or friendly opportunities. Preplanned decision points, branch plans, and sequels, greatly speeds decision making and planning if or when the commander decides to alter the original concept of operation.

1-53. Anticipatory planning also reduces the time between decisions and actions during execution, especially at higher echelons. While some actions are implemented immediately, others require forethought and preparation. For example, changing the direction of attack may be a relatively simple and immediate matter for a squad; however, changing the scheme of maneuver for a division, including its support, is complicated and time-consuming.

Changing the priority of fires at division level may take considerable time if artillery units must reposition. If leaders wait until an event occurs to begin preparing for it, units may not be able to react quickly enough. Proper planning helps reduce crises by anticipating situations before they reach crisis proportions.

### **Planning Helps Simplify Complexity**

1-54. Planning provides a logical way to understand problems and develop solutions to them. Planning is critical when a problem is actually a complex set of interrelated problems, and the solution to each affects the others. The commander may not be able to visualize the various possibilities without the staff working through the problem systematically. If the situation is very complex, planning may offer the only opportunity to deal with the complete set of problems as a whole. Some situations require extensive planning, some very little. In general, the more complex a situation, the more important and involved the planning effort.

1-55. Planning can serve, at least in part, as a substitute for experience. Leaders with enough experience in a situation often know intuitively what to expect, which goals are feasible, and what actions to take. In situations where leaders lack firsthand experience, planning allows them to think through the problem systematically and devise a workable solution.

### **Plans Designate Task Organization and Resource Allocation**

1-56. When assigning missions, commanders ensure subordinates have the means to accomplish them. They do this by task organizing forces and allocating resources. *Task organizing* is the process of allocating available assets to subordinate commanders and establishing their command and support relationships (FM 3-0). Commander's ensure plans designate the task organization, allocate resources, and establish priorities of support to ensure subordinates have the means to accomplish their missions (see Appendix F).

### **Plans Direct and Coordinate Actions**

1-57. Plans and orders tell those within the unit what to do and inform those outside the unit of how to cooperate and provide support. Good plans direct subordinates by stating, "what" is required (the task) and "why" (the purpose); they leave the "how" up to subordinates. They contain the minimum number of control measures needed to coordinate actions and synchronize the BOS to mass the effects of combat power. While synchronization is extremely important, over-emphasizing the directing and coordinating function of planning can lead to detailed and rigid plans that stifle initiative among subordinates. Mission command encourages the use of mission orders to avoid creating overly restrictive instructions to subordinates.

### **Plans Guide Preparation Activities**

1-58. Plans provide a common framework that guides subordinate planning and preparation activities. This framework, particularly the commander's intent and concept of operations, contributes to a shared understanding of



the desired end state and the tasks required to accomplish that end state. Plans guide unit and staff rehearsals, intelligence, surveillance, and reconnaissance operations, coordination, inspection, and movements. Plans direct the positioning of forces and critical resources before execution to ensure the unit is postured for the operation.

## KEY PLANNING CONCEPTS

1-59. Effective planning requires dedication, study, and practice. Planners must be technically and tactically competent and understand basic planning concepts. This section discusses the key planning concepts that aid in effective planning. These include—

- Nested concepts.
- Sequencing operations.
- Control measures.
- Risk mitigation.
- Hasty and deliberate operations.
- Intelligence, surveillance and reconnaissance.
- Planning horizons.
- Parallel and collaborative planning.
- Forward and reverse planning.
- The one-third/two-thirds rule.
- Planning pitfalls.

## NESTED CONCEPTS

1-60. As part of the planning process, commanders visualize their battlespace and determine how to arrange their forces. The *battlefield organization* is the allocation of forces in the area of operations by purpose. It consists of three all-encompassing categories of operations: decisive, shaping, and sustaining (FM 3-0). Purpose unifies all elements of the battlefield organization by providing the common focus for all actions. Commanders organize forces according to purpose by determining whether each unit's operation will be decisive, shaping, or sustaining. These decisions form the basis of the concept of operations.

**Decisive operations** are those that directly accomplish the task assigned by the higher headquarters. Decisive operations conclusively determine the outcome of major operations, battles, and engagements.

**Shaping operations** at any echelon create and preserve conditions for the success of the decisive operations.

**Sustaining operations** are operations at any echelon that enable shaping and decisive operations by providing combat service support, rear area and base security, movement control, terrain management, and infrastructure development.

1-61. The *concept of operations* describes how commanders see the actions of subordinate units fitting together to accomplish the mission. As a minimum, the description includes the scheme of maneuver and concept of fires. The

concept of operations expands the commander’s selected course of action and expresses how each element of the force will cooperate to accomplish the mission (FM 3-0). Where the commander’s intent focuses on the end state, the concept of operations focuses on the method by which the operation uses and synchronizes the BOS to achieve the end state. Commanders ensure that the concept of operations is consistent with both their commander’s intent and that of the next two higher commanders.

1-62. ***Nested concepts*** is a planning technique to achieve unity of purpose whereby each succeeding echelon’s concept of operations is embedded in the other. When developing the concept of operations, commanders ensure their concept is nested within that of their higher headquarters. They also ensure subordinate unit missions are unified by task and purpose to accomplish the mission. A way for the commander and staff to understand their organization’s contribution to the higher headquarters concept is to develop a nesting diagram (see Figure 1-4). Also referred to as a task and purpose tree, the nesting diagram assists the staff in reviewing the horizontal and vertical relationship of units within the higher commander’s concept. A nesting diagram provides a snapshot of the relationship of shaping operations to the decisive operation. The staff may choose to use this technique as a possible way to help analyze the higher headquarters’ order and understand its mission, the commander’s intent, and concept of operations.

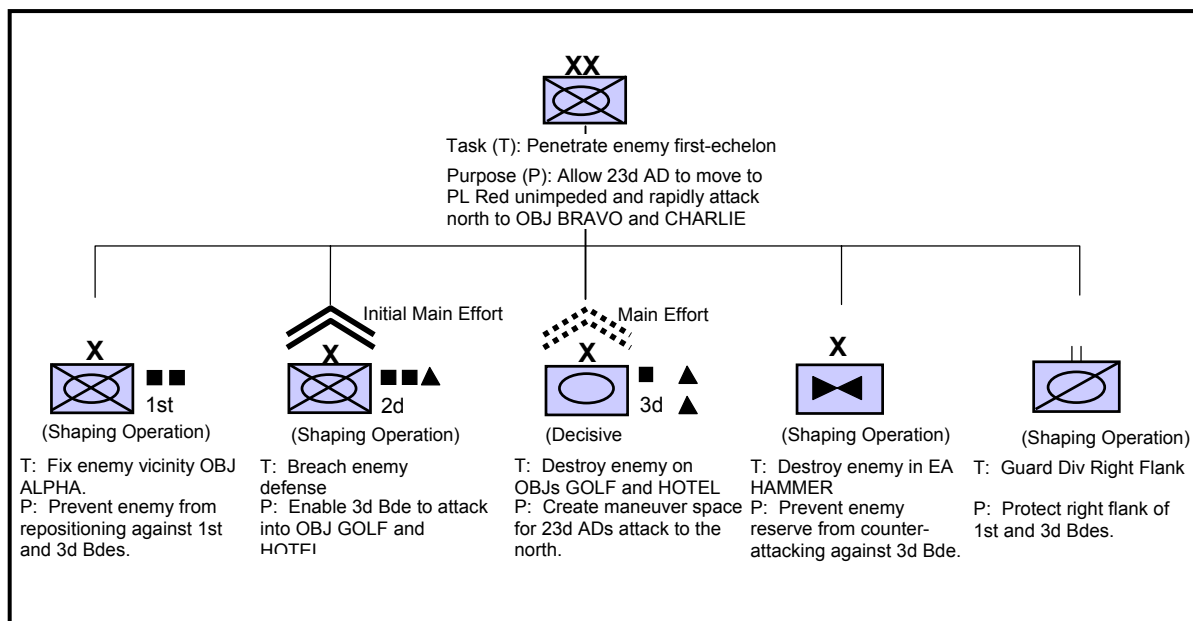

Figure 1-4. Nesting Diagram

## SEQUENCING OPERATIONS

1-63. Part of the art of planning is determining the sequence of activities that accomplish the mission most efficiently. Commanders consider a variety of factors when deciding on the sequence of an operation, the most important factor being resources. Commanders synchronize subordinate unit actions in

time, space, and purpose to link the higher headquarters concept of operations with their own operational design. Ideally, commanders plan simultaneous operations against the enemy system's critical points throughout the AO. However, the size of the friendly force and resource constraints may limit the ability of commanders to execute simultaneous operations. In these cases, commanders phase the operation.

## Phasing

1-64. If a force lacks the means to overwhelm an enemy in a single simultaneous operation, then commanders normally phase the operation. Commanders concentrate combat power at successive points over time, achieving the mission in a controlled series of steps or phases. A *phase* is a specific part of an operation that is different from those that precede or follow. A change in phase usually involves a change of task (FM 3-0). Phasing assists in planning and controlling operations. Considerations of time, distance, terrain, resources, and critical events contribute to the decision to phase an operation.

1-65. Individual phases gain significance only in the larger context of the operation. Links between phases and the requirement to transition between phases are critically important. Commanders establish clear conditions for how and when these transitions occur. Although phases are distinguishable to friendly forces, an effective plan conceals these distinctions from opponents through concurrent and complementary actions during transitions between phases.

## Branches and Sequels

1-66. Operations never proceed exactly as planned. An effective plan places a premium on flexibility. Commanders incorporate branches and sequels into the overall plan to gain flexibility. Visualizing and planning branches and sequels are important because they involve transitions—changes in mission, type of operations, and often forces required for execution. Unless planned, prepared for, and executed efficiently, transitions can reduce the tempo of the operation, slow its momentum, and surrender the initiative to the adversary.

1-67. A *branch* is a contingency plan or course of action (an option built into the basic plan or course of action) for changing the mission, disposition, orientation, or direction of movement of the force to aid success of the current operation, based on anticipated events, opportunities, or disruptions caused by enemy actions. Army forces prepare branches to exploit success and opportunities, or to counter disruptions caused by enemy actions (FM 3-0). Commanders anticipate and devise counters to enemy actions to mitigate risk. Although anticipating every possible threat action is impossible, branches anticipate the most likely ones. Commanders execute branches to rapidly respond to changing conditions.

1-68. *Sequels* are operations that follow the current operation. They are future operations that anticipate the possible outcomes—success, failure, or stalemate—of the current operations (FM 3-0). A counteroffensive, for example, is a logical sequel to a defense; exploitation and pursuit follow successful attacks. Executing a sequel normally begins another phase of an

operation, if not a new operation. Commanders consider sequels early and revisit them throughout an operation. Without such planning, current operations leave forces poorly positioned for future opportunities, and leaders are unprepared to retain the initiative. Both branches and sequels should have execution criteria, carefully reviewed before their implementation and updated based on assessment of current operations.

## CONTROL MEASURES

1-69. Planners develop and recommend control measures to the commander for each COA being considered. **Control measures are directives given graphically or orally by a commander to subordinate commands to assign responsibilities, coordinate fires and maneuver, and control operations. Each control measure can be portrayed graphically. In general, all control measures should be easily identifiable on the ground.**

1-70. Control measures help commander's direct action by establishing responsibilities and limits to prevent units from impeding one another and to impose necessary coordination. They aid the cooperation among forces without imposing needless restrictions on their freedom of action. Control measures can be permissive (which allows something to happen) or restrictive (which limits how something is done). Control measures may be graphical, such as boundaries, or procedural, such as target engagement priorities or certain airspace control measures.

1-71. Well-thought-out control measures established in advance, facilitate freedom of action of subordinates and limit subordinates referring to higher headquarters for permissions to act or not to act during operations. Commanders, however, establish only the minimum control measures necessary to provide essential coordination and deconfliction between units. Effective control measures impose the minimum restrictions on subordinates. The fewer restrictions the more latitude subordinates have to exercise subordinates' initiative. The commander removes restrictive control measures as soon as possible. FM 1-02 discusses the rules for drawing control measures on overlays, maps, and graphic displays, such as annotated aerial photographs.

## RISK REDUCTION

1-72. Uncertainty and risk are inherent in tactical operations. Commanders cannot be successful without the capability of acting under conditions of uncertainty while balancing various risks and taking advantage of opportunities. Planning helps commanders reduce uncertainty and risk. It is a risk management tool.

1-73. During planning, commanders and staffs perform risk management (see FM 100-14). They identify potential hazards to mission accomplishment and assess the probability and severity of each hazard. Commanders determine the acceptable level of risk and express this determination in their planning guidance. The staff uses the commander's risk guidance as a guide for developing control measures to reduce identified hazards and for developing branches. Risk guidance is also incorporated into each COA

developed, and in turn, each COA considered is evaluated by its acceptability. (Acceptability is the degree to which the tactical advantage gained by executing the COA justifies the cost in resources, especially casualties.)

1-74. Because uncertainty exists in all military operations, every military decision incurs some risk. In designing plans, the commander decides how much risk to accept. Figure 1-5, shows several adjustments available to reduce the risk associated in a specific operation. Incorporating risk reduction measures adds to the plan's flexibility during execution.

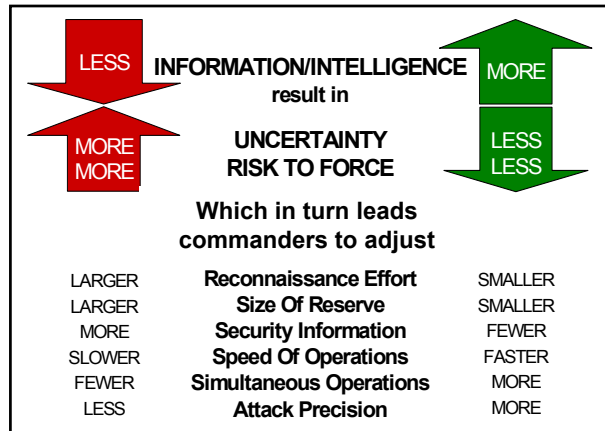

Figure 1-5. Risk Reduction Adjustments

1-75. Risk reduction does not always mean increasing knowledge of the enemy at the expense of time. A flexible plan can partially compensate for a lack of intelligence. Unclear situations may require increasing the depth of the security area, size and number of security units, or size of the reserve. Combat and movement formations that provide for initial enemy contact with the smallest possible friendly force may also be appropriate. Another way to compensate for increased risk is to allocate time and resources for developing the situation to subordinate elements.

## HASTY AND DELIBERATE OPERATIONS

1-76. One of the first decisions commanders make when they receive a new mission or encounter a significant change to the situation is how much time and effort to devote to planning. The uncertain environment of military operations means this decision always entails some risk. Appreciating how time relates to planning requires understanding the differences and tradeoffs between hasty and deliberate operations. The primary differences between hasty and deliberate operations are the enemy and amount of time available for planning and preparation.

1-77. A *hasty operation* is an operation in which a commander directs his immediately available forces, using fragmentary orders, to perform activities with minimal preparation, trading planning and preparation time for speed of execution (FM 3-90). Hasty operations usually occur when a force encounters an unexpected situation during execution.

1-78. A *deliberate operation* is an operation in which a commander's detailed intelligence concerning the situation allows him to develop and coordinate detailed plans, including multiple branches and sequels. He task-organizes his forces specifically for the operation to provide a fully synchronized combined arms team. He conducts extensive rehearsals while conducting

shaping operations to set the conditions for the conduct of his decisive operation (FM 3-90).

1-79. The decision to plan an operation as hasty or deliberate is based on several competing factors. These include the commander's current knowledge of the situation and his assessment of whether the assets available (including time) and means to coordinate and synchronize them can accomplish the mission. If they cannot, the commander takes additional time to plan, prepare, or bring additional forces to bear on the problem. This decision determines the extent to which the operation will be hasty or deliberate.

1-80. Analytic decision making normally supports deliberate operations. However, when planning and preparing for a deliberate operation, commanders take only the minimum time necessary to assure a reasonable chance of success. For example, commanders may be able to reduce the time devoted to planning and preparation when conducting operations against a less-capable and less-prepared enemy. It is better to err on the side of speed, audacity, and momentum than on the side of caution, all else being equal. Such decisions incur calculated risks. Commanders exercise judgment when determining whether the possible advantages merit the risk involved.

## **INTELLIGENCE, SURVEILLANCE, AND RECONNAISSANCE**

1-81. Intelligence, surveillance, and reconnaissance (ISR) combine the production of intelligence with the collection of information through surveillance and reconnaissance. ISR operations produce intelligence on the enemy and environment (to include weather, terrain, and civil considerations) necessary to make decisions. Timely and accurate intelligence depends on aggressive and continuous surveillance and reconnaissance. The quality of available information and intelligence significantly influences the ability to produce a viable plan. The more intelligence available, the better the commander and staff can plan. Less information means that the commander has a greater chance of making a poor decision.

1-82. ISR operations contribute significantly to the commander's visualization and decision making. Commanders aggressively seek information linked to critical decisions by employing ISR units and assets early in planning—usually well before publishing the plan. Employing ISR assets early improves planning quality by providing the commander and staff with current information and confirming or denying assumptions.

1-83. ISR operations help confirm or deny the initial commander's visualization and assist in developing COAs. Information from ISR assets may also allow commanders to focus on a specific COA or eliminate a COA. Additionally, information collected may result in initial plans being modified or even discarded.

1-84. ISR operations cut across the BOSs. They demand an integrated combined arms approach to planning, preparation, execution and assessment. ISR operations are not risk free and require special planning considerations (see Chapter 3). Units conducting ISR missions are normally first to employ, operating in unclear and vague situations. Commanders make skillful yet aggressive use of their ISR assets because there are never

enough of them to accomplish all tasks. They do this by setting priorities, primarily through their planning guidance and CCIR (see FM 3-0 and Chapter 3). Effective ISR planning ensures that available ISR assets produce the greatest results to support the commander's decision making throughout the operation.

## PLANNING HORIZONS

1-85. Tension exists between how far ahead commanders can plan effectively without preparation and coordination becoming irrelevant. Planning too far into the future may overwhelm the capabilities of planning staffs, especially subordinate staffs. Not planning far enough ahead may result in losing the initiative and being unprepared. In addition, planning too far into the future may result in plans that are never executed due to changing events. Understanding this tension is key to ensuring the command is focused on the right planning horizon.

1-86. A **planning horizon** is a point in time commanders use to focus the organization's planning efforts to shape future events. Planning horizons are measured from weeks or months for operational-level commanders to hours and days for tactical-level commanders. Organizations often plan within several different horizons simultaneously. To guide their planning efforts, commanders use three planning horizons—commitment planning (short-range), contingency planning (mid-range), and orientation planning (long-range) (see Figure 1-6). Commanders focus the staff on the appropriate planning horizon.

### Commitment Planning

1-87. Commitment planning is short-range focused under condition of relative certainty. Commitment planning occurs when commanders believe they can reasonably forecast events; assign resources, and commit to a particular plan. Commitment planning directs the physical preparations necessary for action such as staging supplies, task organizing, and positioning of forces for execution. Commitment planning results in an OPORD or FRAGO.

### Contingency Planning

1-88. In conditions of moderate certainty and within a mid-range planning horizon, commanders plan for several different possibilities without

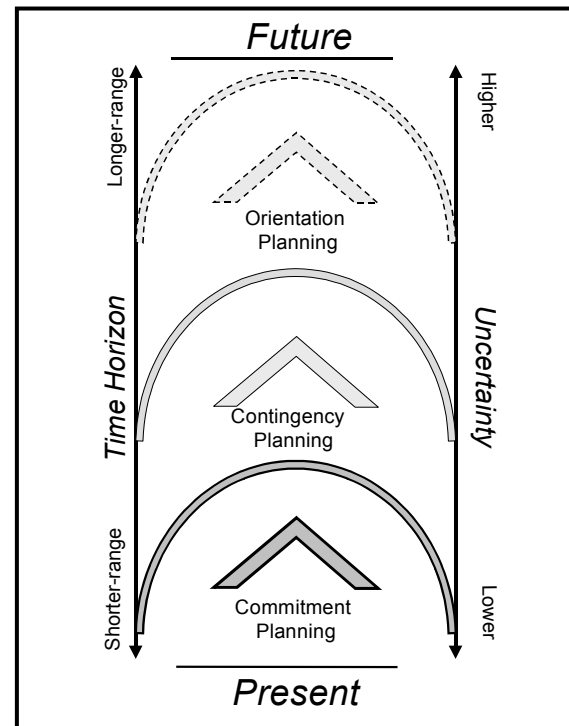

Figure 1-6. Planning

committing to any one (contingency planning). Units and resources are programmed—but not physically committed—for several projected circumstances under conditions of moderate uncertainty. Developing branches and sequels is normally the focus of contingency planning.

### Orientation Planning

1-89. Beyond the contingency planning horizon, the situation is too uncertain to plan for specific contingencies. Commanders develop broad concepts addressing a number of different circumstances over a longer time period. This orientation planning allows them to respond quickly and flexibly to a broad variety of circumstances. Developing OPLANs in concept form for several scenarios in the distant future is an example of orientation planning.

### PARALLEL AND COLLABORATIVE PLANNING

1-90. Commanders ensure that plans are sent to subordinates in enough time to allow them to adequately plan and prepare their own operations. To accomplish this, echelons plan in parallel as much as possible. Additionally, new information systems (INFOSYS) enable echelons to plan collaboratively without being co-located.

### Parallel Planning

1-91. ***Parallel planning is two or more echelons planning for the same operation nearly simultaneously. It is facilitated by continuous information sharing by the higher headquarters with subordinate units concerning future operations.*** Parallel planning requires significant interaction between echelons. With parallel planning, subordinate units do not wait for their higher headquarters to publish an operations order to begin their own planning and orders development process.

1-92. Parallel planning emphasizes the early, continuous, and rapid sharing of planning information among subordinate, supporting, adjacent, and higher staff elements. The result of this continuous information sharing is that units at all echelons receive information on a future mission early in the higher headquarters' planning process. This information sharing enables subordinates to begin planning concurrently with their higher headquarters instead of waiting until the higher headquarters completes its plan.

1-93. Parallel planning is facilitated by timely warning orders. Parallel planning techniques are built into the MDMP (see Figure 1-7 and Chapter 3). The MDMP prescribes a minimum of three warning orders issued to subordinates during the planning process. These warning orders are issued following receipt of mission, mission analysis, and COA approval. Commanders issue additional warning orders to disseminate new guidance or directives as required by the situation. Additionally, frequent communication over staff channels and sharing information, such as intelligence preparation of the battlefield (IPB) products, help subordinate headquarters plan.



## Collaborative Planning

1-94. **Collaborative planning** is the real-time interaction among commanders and staffs at two or more echelons developing plans for a single operation. Collaborative planning greatly speeds decision making by providing the higher commander with real-time information about what subordinates can and cannot do. Collaborative planning enables subordinates to provide the higher commander with their current assessment and status, and how they are postured for various operations. This information helps the higher commander determine what is possible for subordinate units. In addition, collaborative planning allows sharing ideas and concepts for COA development. Often, subordinates have insights into how an operation might unfold, based on their intimate knowledge of the enemy and terrain.

1-95. Collaborative planning is enabled by information systems that allow real-time exchange of information by voice, and video. This capability allows commanders and staffs to collaborate throughout planning. Collaborative planning enhances understanding of the commander's intent and planning guidance throughout the force and decreases the time required for all echelons to complete a plan.

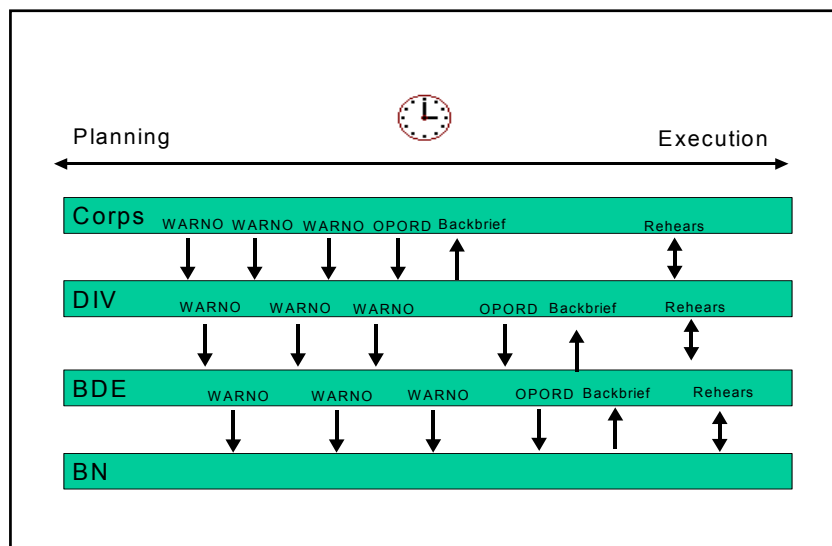

Figure 1-7. Parallel Planning and the MDMP

## FORWARD AND REVERSE PLANNING

1-96. Commanders and planners use two planning techniques: forward planning and reverse planning.

1-97. Forward planning involves starting with the present conditions and laying out potential decisions and actions forward in time, identifying the next feasible step, the next after that, and so on. Forward planning focuses on what is feasible in the relatively short term. In forward planning, the envisioned end state serves as a distant and general aiming point rather than as a specific objective. Forward planning answers the question, where can we get to next?

1-98. Reverse planning involves starting with the envisioned end state and working backward in time toward the present (see Figure 1-8). Planners begin by identifying the last step, the next-to-last step, and so on. They continue until they reach the step that begins the operation. Reverse planning focuses on the long-term goal. It answers the question, where do we eventually want to get?

1-99. To plan effectively in reverse, commanders require a clear and relatively permanent goal; alternatively, they may define the goal broadly enough to provide a valid point of reference, regardless of how the situation may develop. Consequently, effective reverse planning is possible only in relatively predictable situations. For example, given a fixed deadline, commanders often use reverse planning to allocate preparation time. Reverse planning is common at lower tactical echelons and is an important aspect of TLP (see Chapter 4).

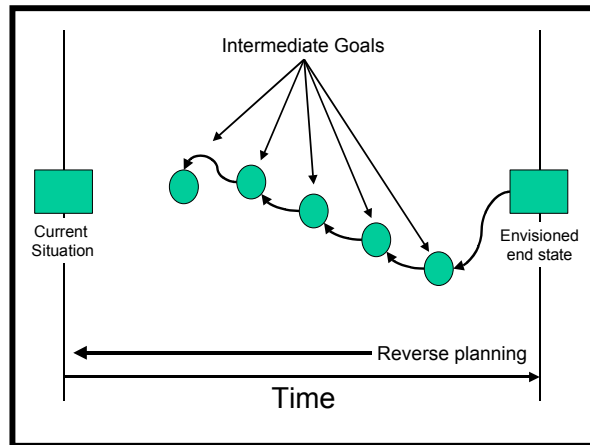

**Figure 1-8. Reverse Planning**

1-100. Of the two methods, forward planning is the more natural because it is consistent with the direction time moves and the way humans act. Reverse planning is more difficult because it proceeds opposite to the way humans naturally think and act and because goals in military operations change over the long term. In practice, planning effectively often means combining the two methods, using forward planning to provide an idea of what is feasible in the short term and reverse planning to provide a point of aim over the long term.

### ONE-THIRD/TWO-THIRDS RULE

1-101. Commanders and staffs often underestimate the time required for directives to pass through the echelons of an organization. Effective planning demands issuing timely plans to subordinates. Timely plans are those issued soon enough to allow subordinates enough time to plan, issue their orders, and prepare for the operations. Few factors are more important than giving subordinates enough time to prepare.

1-102. Commanders follow the “one-third/two-thirds rule” to allocate time available for planning and preparation: they use one-third of the time available for their planning and allocate the remaining two-thirds to their subordinates. However, modern information systems and parallel and collaborative planning techniques can enable commanders to obtain more of a one-fifth/four-fifths planning ratio.

1-103. Brevity during planning is essential; so is speed. Effective staffs avoid consuming too much time developing lengthy plans that contain irrelevant

details. When plans arrive late, subordinates can only react. Subordinate commanders are often forced to forego the advantages of analytic planning. To save time and shorten plans, commanders and staffs anticipate support requirements and forecast options. Headquarters at each level plan in parallel with higher and lower headquarters. Parallel planning expedites the exchange of information among headquarters through WARNOs and should be used as much as possible.

## PLANNING PITFALLS

1-104. Commanders recognize both the benefits and the potential pitfalls of planning. They ensure that planning is performed properly to avoid them. Planners' guard against several common mistakes. These pitfalls generally stem from a common cause: the failure to appreciate the unpredictability and uncertainty of military operations. Pointing these out is not a criticism of planning but of improper planning. Commanders discipline the planning process and teach staffs the relevance of product content. Common pitfalls include—

- Attempting to forecast and dictate events too far into the future.
- Delaying planning to gain more detailed information.
- Planning in too much detail.
- Using planning as a scripting process.
- Applying planning techniques inflexibly.

### Attempting To Forecast Events Too Far Into The Future

1-105. Planning, by definition, is future oriented. It is essential to seizing and retaining the initiative. However, planners often err by attempting to forecast and dictate events too far in the future, or focusing on the wrong planning horizon. It is a natural tendency to plan based on the assumption that the future will be a continuation of present conditions. Doing this may result in underestimating the scope of changes or the direction in which they may occur. German Field Marshal Helmuth von Moltke's well-known dictum above does not demean the value of planning; it reminds commanders and staffs of the relationship between planning and executing.

*...no plan...extends with any degree of certainty beyond the first encounter with the main force.*

German Field Marshal Helmuth  
von Moltke

1-106. While it is imperative to plan, planning too far ahead can consume valuable time and effort on events that have little or no chance of occurring. This may result in plans being executed without relationship to the actual situation. Planning too far ahead can also create a false sense of ability to predict the future.

1-107. The purpose of any plan is to establish the conceptual basis for action. A plan provides a reasonably accurate forecast of execution. Because it is difficult to anticipate the unexpected, it is common to believe the unexpected will not occur. Often plans are overcome by events much more than

anticipated. Therefore, effective planners do not try to plan too far into the future.

### **Delaying Planning To Gain More Detailed Information**

1-108. Occasionally, planners will delay planning to wait on more information from higher headquarters or to gain detailed information on the enemy. If time is short, and the situation requires action, planners cannot afford to wait for all information necessary to produce the perfect plan. Often, there is enough information available to begin the planning process, develop a base concept, and adjust the plan as new information is received.

1-109. The parallel planning procedures in the MDMP (see Chapter 3) and TLP (see Chapter 4), call for the higher headquarters to send a series of WARNOs throughout their planning effort. These WARNOs are designed to provide subordinates with information as it becomes available and enables them to begin planning even without a complete plan or order from higher.

### **Planning in Too Much Detail**

1-110. Planners tend to plan in too much detail as opposed to developing simple and flexible plans. This is not a criticism of detailed planning but of planning in more detail than conditions warrant. This pitfall often stems from the desire to leave as little as possible to chance. In general, the less certain the situation, the less detail in which one can plan. However, the natural response to the anxiety of uncertainty is to plan in greater detail—to try to cover every possibility. This effort can generate even more anxiety, which leads to planning in even more detail. The result can be an extremely detailed plan that does not survive the friction of the situation, constricts effective action, and arrives too late for subordinates to effectively execute.

1-111. Military operations are complicated endeavors that require a good deal of detailed planning. Combat service support planning, air movement tables, and intelligence synchronization plans are all examples of portions of plans that require close coordination and attention to detail. Those parts of a plan most affected by potential enemy action should have the least detail, those least affected by enemy action the most detail. The underlying principle is conveying an easily understood concept of operations, putting the fewest restrictions on subordinates, and allowing them the greatest flexibility in execution. Mission orders are a technique for developing simple and flexible plans.

### **Using Planning As A Scripting Process**

1-112. The tendency to use planning as a scripting process that tries to prescribe friendly, and even enemy, actions with precision is another planning pitfall. When planners fail to recognize the limits of foresight and control, the plan can become overly regulatory restricting initiative and flexibility. Subordinates then focus on the requirements of the plan rather than on making decisions and acting effectively. During execution, successful commanders fight the enemy, not the plan. Good plans facilitate initiative, not constrain it.

### Applying Planning Techniques Inflexibly

1-113. There is a tendency for planning methods to lead to inflexible or lockstep thinking and for planning and plans to become rigid and overly emphasize procedures. While planning is a disciplined framework for approaching problems, the danger is in taking that discipline to the extreme. It is natural to develop routines to streamline planning efforts. In fact, effective standing operating procedures provide economy of effort and coordination among those working on the same problem. They are essential to effective planning. In situations where planning activities must be performed repeatedly with little variation, it helps to have well-rehearsed procedures in place. However, even with well-rehearsed procedures, two dangers still exist.

1-114. The first danger is in trying to reduce those aspects of planning that require intuition and creativity to simplify procedures; for example, basing a COA solely on the mathematical correlation of enemy and friendly forces. Many planning skills cannot be captured in procedures. Attempts to do so restrict intuition and creativity.

1-115. The second danger is that, even where procedures are appropriate, they tend to become rigid over time. Always conducting a detailed war game of multiple COAs without considering the planning time available is an example of following procedure at the expense of the product. Inflexibility directly undermines the objective of planning—enabling the organization to adapt in the fluid combat environment.

## DIGITAL ENHANCEMENTS TO PLANNING

1-116. The Army is currently transitioning to a digitally-based information system that will form the basis for commanders' C2 systems. These systems are designed to provide commanders and staffs with timely, accurate, mission-critical information to support effective C2. The range of digital devices the Army is fielding greatly enhances both analytical and intuitive decision making. Modern information systems should enhance planning in several ways:

- Collect information more efficiently than analog systems.
- Process information faster and more accurately than analog systems.
- Allow information to be stored in a manner that provides rapid access through distributed databases.
- Display information in useable, tailorable, and common formats.
- Disseminate information to the right place faster with fewer errors and less lag time than analog systems.
- Allow leaders access to expertise and databases through reachback to Service, national, and civilian institutions.

1-117. Modern information systems, coupled with information management, give commanders the capability of developing and disseminating a COP. The COP leads to commanders achieving a shared situational understanding that, in turn, speeds planning and decision making (see FM 6-0).

1-118. Modern information systems enhance planning between echelons. This capability includes echelons of parallel planning, collaborative planning,

or both. Information systems use distributed databases and improve the speed and accuracy in which information is exchanged. They allow commanders and staffs to effectively collaborate without being co-located.

1-119. The most significant challenge to planning is overcoming uncertainty. Traditionally, commanders have devoted a significant amount of planning time to developing situational understanding. A large effort by staffs is devoted to gathering information to produce or update products that help commanders understand the current state of the enemy, friendly forces, and the environment. Now, distributed databases and modern information systems enable commanders at all echelons to share information immediately. This capability allows commanders to share a COP. This capability significantly speeds situational understanding and enables commanders and staffs to develop feasible COAs faster.

## EFFECTIVE PLANNING

1-120. Effective planning is both art and science. It can involve a detailed, systematic analysis to produce an optimal COA. Alternatively, planning may be a rapid process that reaches an acceptable COA quickly by considering only critical aspects of the problem. When planning under time-constrained conditions, the staff is usually responding to existing conditions and needs a quick plan for immediate or near future execution. All planning takes time and must facilitate generating or maintaining the tempo the commander desires.

1-121. Planning is a dynamic process of several interrelated activities. It starts when the commander receives or perceives a new mission. It supports decision making by analyzing the factors of METT-TC and by providing a context for developing situational understanding. The outcome of planning is the commander's decision about how to conduct the operation. After this decision, the staff continues planning by creating an order or plan. Planning continues during preparation and execution, whether by refining the plan or by creating or refining branches and sequels.

1-122. Effective planning requires a sensitive awareness of and skillful use of time. Plans should always be completed as soon as possible to maximize subordinate planning time. Staffs use frequent WARNOs and collaborative planning to facilitate parallel planning with subordinates. In addition, just because time is available does not mean that orders or plans need to be too detailed or long; mission orders should be as simple as possible, providing the maximum latitude for subordinates.

1-123. Although planning attempts to project the commander's thoughts and designs forward in time, it involves an appreciation for planning horizons. Because the future is always uncertain, plans should not specify future actions with precision. Rather, they remain flexible and adaptable, allowing the opportunity to pursue a variety of options.

1-124. Mission command requires plans that give subordinates the flexibility to exploit opportunities and respond to threats. Commanders decentralize planning to the lowest possible level so subordinates have maximum freedom of action. A plan should not be a script that establishes specific actions and

timetables. Such scripting severely limits possibilities to seize, retain, and exploit the initiative when unexpected threats or opportunities arise. A good mission order creates opportunities for subordinates' initiative within the commander's intent and the circumstances.





## Chapter 2

# Army Problem Solving

This chapter describes a standard, systematic approach for solving problems. It discusses critical reasoning skills and problem solving techniques in a group setting. Army problem solving is applicable to all Army activities, not just operations. It establishes the base logic for the Army's two tactical planning processes: troop leading procedures and the military decision making process. Chapter 2 assumes more than one person is working on the problem; however, the techniques apply to individuals as well. Formats for staff studies and decision papers, products of Army problem solving, are located in Appendix A. Decision briefings are discussed in Appendix B.

### PROBLEM SOLVING AND DECISION MAKING

2-1. The ability to recognize and effectively solve problems is an essential skill for Army leaders (see FM 22-100). Army problem solving is a form of decision making. It is a systematic approach to defining a problem, developing possible solutions to solve the problem, arriving at the best solution, and implementing it. The object of problem solving is not just to solve near-term problems, but to also do so in a way that forms the basis for long-term success.

2-2. Not all problems require lengthy analysis to solve. For simple problems, leaders often make decisions quickly—sometimes on the spot. However, for complicated problems involving a variety of factors, a systematic problem solving approach is essential. The amount of analysis required to effectively solve a problem depends on the problem's complexity, the leader's experience, and amount of time available.

2-3. Army problem solving supports a single leader working alone or a group of Army leaders working together. Commanders normally direct their staff or subordinate leaders to recommend solutions to problems. In formal situations, they present their recommendations as staff studies, decision papers, and decision briefings (see Appendices A and B). At lower echelons,

#### CONTENTS

<b>Problem Solving and Decision making.....</b>	<b>2-1</b>	<b>Identify the Problem .....</b>	<b>2-6</b>
<b>    Critical Reasoning.....</b>	<b>2-2</b>	<b>Gather Information .....</b>	<b>2-7</b>
<b>    Creative Thinking .....</b>	<b>2-4</b>	<b>Develop Criteria .....</b>	<b>2-9</b>
<b>Solving Problems in a Group Setting.....</b>	<b>2-4</b>	<b>Generate Possible Solutions.....</b>	<b>2-11</b>
<b>Structure of Problems.....</b>	<b>2-5</b>	<b>Analyze Possible Solutions.....</b>	<b>2-12</b>
<b>Solving Problems .....</b>	<b>2-5</b>	<b>Compare Possible Solutions.....</b>	<b>2-13</b>
		<b>Make and Implement the Decision.....</b>	<b>2-13</b>

recommendations are normally presented orally.

2-4. Problem solving is both an art and a science. It is a highly structured analytic process designed to ensure that all key factors relevant to the problem are considered, and that all relationships between variables are anticipated and accounted for in the solution. This ensures that the desired objective or end-state is achieved in the most effective and efficient manner.

2-5. The art of problem solving involves subjective analysis of variables that, in many cases, cannot be easily measured. Leadership and morale, for example, are difficult to measure, but may play a critical role in developing solutions to solve a problem. Problem solvers and decision makers make subjective assessments of such variables based on facts and assumptions and their likely effects on the outcome. A leader's judgment is enhanced by their professional experience.

2-6. The science of problem solving involves the use of various quantitative analytical tools available to the staff. Quantitative analysis seeks to define and evaluate relevant factors or variables that can be measured or counted. Quantitative analysis can be useful for identifying trends in data sets, and sharp departures from expected norms or measurements. The results are often organized and displayed in the form of charts and graphs. Quantitative analysis requires measuring or counting the values of relevant variables, and calculating changes in the observed effects on the problem or variable of interest. When a correlation can be established between two variables, it is possible to predict the effects on the dependent variable when changes occur in the value of the independent variable. For example, calculating the correlation of forces in a tactical problem is accomplished through a quantitative analysis process. If the outcome is unfavorable or puts the operation at risk, commanders can allocate more forces and observe the effect on the correlation of forces ratio.

2-7. The highly structured nature of the Army problem solving process depicted in Figure 2-1, page 2-6, helps inexperienced staff officers to identify and consider key factors relevant to the problem. It also provides the more intuitively gifted and experienced officer with a framework for analyzing and solving complex problems. The Army problem solving process helps to ensure that no key piece of information is overlooked in the analysis, thereby minimizing the risk of unforeseen developments or unintended consequences.

## **CRITICAL REASONING**

2-8. Army leaders are faced with a variety of problems, each requiring its own solution. A problem may be broad and conceptual, such as how to improve unit readiness; or more refined, such as determining the best allocation of a critical resource. Critical reasoning (thinking) is key to understanding situations, finding causes, arriving at justifiable conclusions, making good judgments, and learning from experience—in short, problem solving.

2-9. Critical reasoning is the purposeful, self-regulating judgment that includes interpretation, analysis, evaluation, and inference that leaders use to solve problems. It is an essential leader skill and is a central aspect of decision making. The word “critical” in this context does not mean finding

fault. Critical reasoning means getting past the surface of the problem and thinking about the problem in depth. It means looking at a problem from several points of view instead of being satisfied with the first answer that comes to mind. Army leaders need this ability because many of the choices they face are complex and offer no easy solution.

2-10. Developing good critical reasoning skills is crucial for effective problem solving and requires study and practice. There are several cognitive skills involved in critical reasoning to include:

- **Interpretation.** Leaders must comprehend and express the meaning or significance of a wide variety of experiences, situations, data, events, and judgments. Examples of interpretation include, recognizing and describing a problem or clarifying what a chart or graph means.
- **Analysis.** The problem solver must identify the intent of statements, ideas, and concepts provided for interpretation. Examining ideas and determining and analyzing arguments are sub-skills of analysis. Identifying the similarities and differences between two solutions for a given problem is an example of analysis.
- **Evaluation.** Leaders must assess the credibility of statements or other representations such as a perception, experience, situation, judgment, or belief relevant to the problem. They also assess the logical strength of the actual or intended relationships among statements, descriptions, questions or other forms of representations.

2-11. Good critical thinkers must also explain the logic of their interpretation in reaching conclusions. They must explain what they think and how they arrived at the judgment. They also are good at self-regulating themselves to improve on their previous opinions.

- **Explanations.** When presenting recommendations, leaders must be able to state the method of reasoning. They justify their reasoning in terms of the facts, assumptions, and criteria upon which their results were based. They must also be able to present their reasoning in the form of a cogent argument.
- **Self-regulation.** When solving problems, leaders must self-consciously monitor their cognitive activities, the elements used in those activities, and the results produced. They do this particularly by applying skill in analysis, and evaluation to their own judgments with a view toward questioning, confirming, validating, or correcting either their reasoning or results. An example is for the problem solver to examine their views on a controversial issue with sensitivity to the possible influences of personal biases or self-interest.

2-12. Ideally, the critical thinker is habitually inquisitive, well-informed, trustful of reason, open minded, flexible, fair minded in evaluation, honest in facing personal biases, prudent in making judgments, and willing to reconsider options. Good critical thinkers share these characteristics:

- State the problem clearly.
- Work in an orderly manner.
- Seek relevant information diligently.
- Select and apply criteria in a reasonable manner.

- Carefully focus attention on the problem at hand.
- Are precise as permitted by the subject and the circumstances.

## CREATIVE THINKING

2-13. Sometimes leaders face problems that they are not familiar with or an old problem requires a new solution. In this instance, leaders must apply imagination, a departure from the old way of doing things. Army leaders prevent complacency by finding ways to challenge subordinates with new approaches and ideas. Leaders rely on their intuition, experience, and knowledge. They ask for input from subordinates to reinforce team building by making everybody responsible for, and a shareholder in, the accomplishment of difficult tasks.

2-14. Creative or innovative thinking is the kind of thinking that leads to new insights, novel approaches, fresh perspectives, and whole new ways of understanding and conceiving things. Creative thinking is not a mysterious gift, nor does it have to be outlandish. It is not reserved for senior officers, all leaders should think creatively. Creative thinking is employed everyday to solve small problems.

## SOLVING PROBLEMS IN A GROUP SETTING

2-15. Creativity by Army leaders is key to developing effective solutions to problems. Often, groups can be far more creative than individuals. While working in a group is advantageous, group problem solving has potential pitfalls. One of these pitfalls is “groupthink.”

2-16. Groupthink is a common failing of people or groups who work together to make decisions or solve problems. It is a barrier to creativity that combines habit, fear, and prejudice:

- **Habit**—the reluctance to change from accepted ways of doing things.
- **Fear**—the feeling of agitation and anxiety caused by being uneasy or apprehensive about: both fear of discarding the old to adopt the new and fear of being thought of as a fool for recommending the new.
- **Prejudice**—preconceived opinion formed without a rational basis or with insufficient knowledge.

2-17. Groupthink refers to a mode of thinking that people engage in when they are deeply involved in a cohesive group. It occurs when members, striving for agreement, override their motivation to realistically evaluate alternative courses of action. The group makes a collective decision and feels good about it because all members favor the same decision. In the interest of unity and harmony, there is no debate or challenge to the selected solution.

2-18. Being aware of the existence of groupthink is the most important factor in avoiding it. Following these practices helps avoid groupthink:

- The leader should encourage members to express objections or doubts.
- The presenter of a problem should refrain from expressing preferences about potential solutions.
- The leader should assign two independent subgroups to work on the problem.

- The leader should ask people outside the group for input.
- The leader should assign at least one member of the group the role of adversary to critically examine the group's decision process.
- After reaching a preliminary consensus, the group should reconsider previously considered solutions.

## STRUCTURE OF PROBLEMS

2-19. In terms of structure, there are three types of problems: well structured, medium structured, and ill structured. Understanding the structure of a problem assists in determining the amount of time and resources required to develop a recommended solution to the problem. Perception of whether a problem is well, ill, or medium structured depends, in part, on the knowledge, skills, and ability of the problem solver.

2-20. Well-structured problems are the easiest problems to deal with since—

- All required information is available.
- The problem is well defined.
- A solution technique (formula or algorithm) with few variables is available that makes analysis easy.
- There is a correct, verifiable answer.

2-21. Medium-structured problems represent the preponderance of the problems Army leaders face. These types of problems fall between the two extremes of well- and ill-structured problems. In these medium-structured problems, problem solvers may find that—

- Some information is available.
- The problems may be partially defined.
- Such problems may or may not lend themselves to routine solutions.
- The problems require some creative skills to solve.
- The problems normally involve making assumptions about future conditions or impacting current actions on the future.

2-22. Ill-structured problems are at the opposite end of the spectrum since—

- No clear formulation of the problem appears possible.
- Not all required information is available.
- They are complex involving many variables, making them difficult to analyze.
- These are normally problems of prediction with no verifiable answer.
- They may require multiple solutions applied concurrently or sequentially. Problem solvers must sometimes reduce complex ill-structured problems into smaller problems.

## SOLVING PROBLEMS

2-23. Problem solving is a daily activity for Army leaders. Army problem solving is a systematic way to arrive at the best solution to a problem. It applies at all echelons and includes the steps needed to develop well-reasoned, supportable solutions (see Figure 2-1). It incorporates risk management techniques appropriate to the situation (see FM 100-14). Army leaders remain as objective as possible when solving problems. The goal is to

prepare an unbiased solution or recommendation for the decision maker, based on the facts. Problem solving is an important Army leadership action (see FM 22-100). It is essential to good staff work.

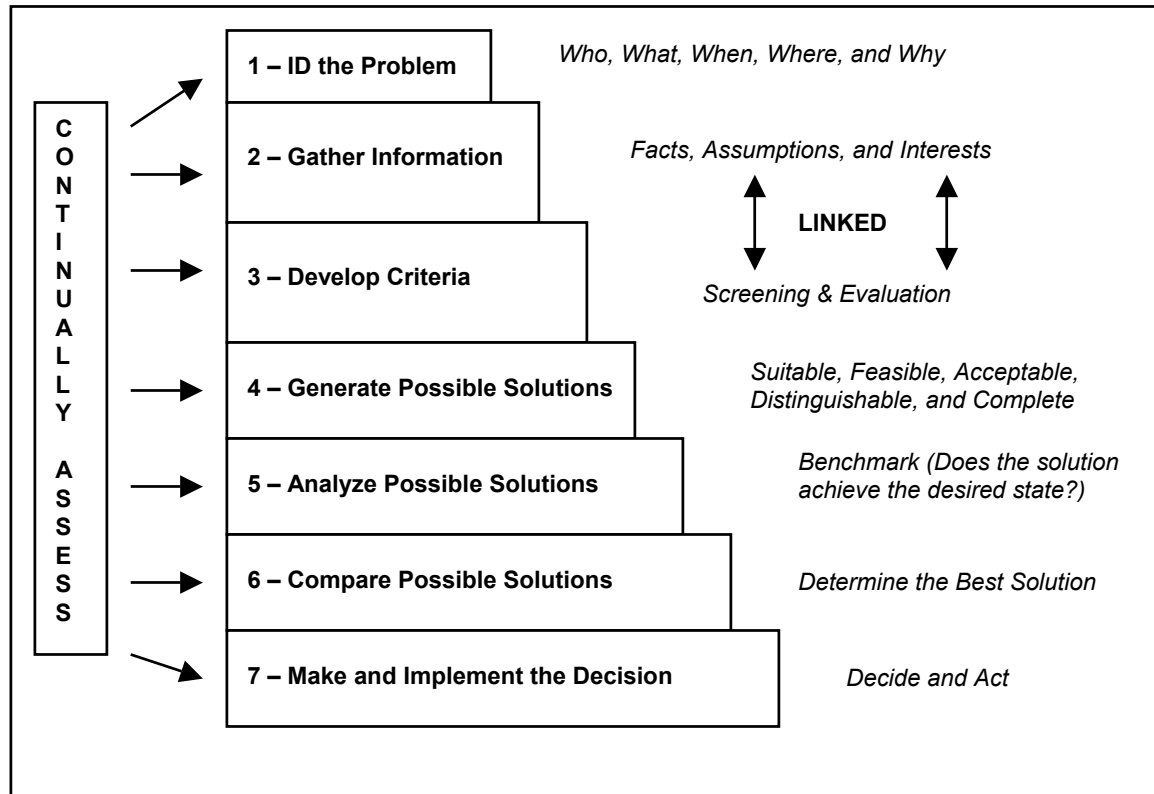

Figure 2-1. Seven Step Problem-Solving Model

**IDENTIFY THE PROBLEM**

2-24. The first step in problem solving is recognizing and defining the problem. This step is crucial, as the actual problem may not be obvious upfront. Therefore, leaders determine what the problem is by clearly defining its scope and limitations. Leaders should allow sufficient time and energy to clearly define the problem before moving on to other steps of problem solving process.

2-25. A problem exists when there is a difference between the current state or condition and a desired state or condition. Army leaders identify problems from a variety of sources. These include—

- Higher headquarters directives or guidance.
- Decision maker guidance.
- Subordinates.
- Personal observations.

2-26. When identifying the problem, leaders actively seek to identify its root cause, not merely the symptoms on the surface. Symptoms may be the reason that the problem became visible. They are often the first things noticed and

frequently require attention. However, focusing on a problem's symptoms may lead to false conclusions or inappropriate solutions. Using a systematic approach to identifying problems helps avoid the "solving symptoms" pitfall.

2-27. To identify the root cause of a problem, leaders do the following:

- Compare the current situation to the desired end state.
- Define the problem's scope or boundaries.
- Answer the following questions:
  - Who does the problem affect?
  - What is affected?
  - When did the problem occur?
  - Where is the problem?
  - Why did the problem occur?
- Determine the cause of obstacles between here and the solution. Many times the causes of a problem are simply obstacles between the current situation and the desired end state.
- Write a draft problem statement.
- Redefine the problem as necessary as new information is acquired and assessed.

2-28. After identifying the root causes, leaders develop a problem statement. A problem statement is written as an infinitive phrase: such as, "To determine the best location for constructing a multipurpose vehicle wash rack facility during this fiscal year." When the problem under consideration is based upon a directive from a higher authority, it is best to submit the problem statement to the decision maker for approval. This ensures the problem solver has understood the decision maker's guidance before continuing.

2-29. Once they have developed the problem statement, leaders make a plan to solve the problem. Leaders make the best possible use of available time and allocate time for each problem-solving step. Doing this provides a series of deadlines to meet in solving the problem. Leaders use reverse planning to prepare their problem solving time line (see Chapter 1). They use this time line to periodically assess their progress. They do not let real or perceived pressure cause them to abandon solving the problem systematically. They change time allocations as necessary, but they do not ignore them.

## **GATHER INFORMATION**

2-30. After completing the problem statement, leaders continue to gather information relevant to the problem. Gathering information begins with problem definition and continues throughout the problem solving process. Army leaders never stop acquiring and assessing the impact of new or additional information.

2-31. When gathering information, Army leaders define unfamiliar terms. Doing this is particularly important when dealing with technical information. Leaders consider the intended audience in deciding what to define. For example: a product for an audience that includes civilians may require definitions of all Army terms. A technical report prepared for a decision

maker unfamiliar with the subject should include definitions the reader needs to know to understand the report.

2-32. Army leaders gather information from primary sources whenever possible. Primary sources are people with first-hand knowledge of the subject under investigation, or documents produced by them. Methods of gathering information from primary sources include interviews, letters of request for specific information, and questionnaires.

2-33. Two types of information are required to solve problems: facts and assumptions. Fully understanding these types of information is critical to understanding problem solving. In addition, Army leaders need to know how to handle opinions and how to manage information when working in a group.

## **Facts**

2-34. Facts are verifiable pieces of information or information presented that has objective reality. They form the foundation on which the solution to a problem is based. Regulations, policies, doctrinal publications, commander's guidance, plans and orders, personal experience, and the Internet are just a few sources of facts.

## **Assumptions**

2-35. An assumption is information accepted as true in the absence of facts. This information is probably correct, but cannot be verified. Appropriate assumptions used in decision making have two characteristics:

- They are valid, that is, they are likely to be true.
- They are necessary, that is, they are essential to continuing the problem solving process.

If the process can continue without making a particular assumption, it is discarded. So long as an assumption is both valid and necessary, it is treated as a fact. Problem solvers continually seek to confirm or deny the validity of their assumptions.

## **Opinions**

2-36. When gathering information, Army leaders evaluate opinions carefully. An opinion is a personal judgment that the Army leader or another individual makes. Opinions cannot be totally discounted. They are often the result of years of experience. Army leaders objectively evaluate opinions to determine whether to accept them as facts, include them as opinions, or reject them. Army leaders neither routinely accept opinions as facts nor reject them as irrelevant—regardless of their source.



## Organizing Information

2-37. Army leaders check each piece of information to verify its accuracy. If possible, two individuals should check and confirm the accuracy of facts and the validity of assumptions.

2-38. Being able to establish whether a piece of information is a fact or an assumption is of little value if those working on the problem do not know the information exists. Army leaders share information with the decision maker, subordinates, and peers, as appropriate. A proposed solution to a problem is only as good as the information that forms the basis of the solution. Sharing information among members of a problem solving team increases the likelihood that a team member will uncover the information that leads to the best solution.

2-39. Organizing information includes coordination with units and agencies that may be affected by the problem or its solution. Army leaders determine these as they gather information. They coordinate with other leaders as they solve problems, both to obtain assistance and to keep others informed of situations that may affect them. Such coordination may be informal and routine: for example, a squad leader checking with the squad on his right to make sure their fields of fire overlap; or it may be formal, as when a division action officer staffs a decision paper with the major subordinate commands. As a minimum, Army leaders always coordinate with units or agencies that might be affected by a solution they propose before they present it to the decision maker.

## DEVELOP CRITERIA

2-40. The next step in the problem solving process is developing criteria. A criterion is a standard, rule, or test by which something can be judged—a measure of value. Problem solvers develop criteria to assist them in formulating and evaluating possible solutions to a problem. Criteria are based on facts or assumptions. Problem solvers develop two types of criteria: screening and evaluation criteria.

### Screening Criteria

2-41. Army leaders use screening criteria to ensure solutions being considered can solve the problem. Screening criteria defines the limits of an acceptable solution. As such, they are tools to establish the baseline products for analysis. A solution may be rejected based solely on the application of screening criteria. Five categories of screening criteria are commonly applied to test a possible solution:

- **Suitability**—solves the problem and is legal and ethical.
- **Feasibility**—fits within available resources.
- **Acceptability**—worth the cost or risk.
- **Distinguishability**—differs significantly from other solutions.
- **Completeness**—contains the critical aspects of solving the problem from start to finish.

## Evaluation Criteria

2-42. After developing screening criteria, the problem solver develops the evaluation criteria in order to differentiate among possible solutions (see Figure 2-2). Well-defined evaluation criteria have five elements:

- **Short Title**—the criterion name.
- **Definition**—a clear description of the feature being evaluated.
- **Unit of Measure**—a standard element used to quantify the criterion. Examples of units of measure are US dollars, miles per gallon, and feet.
- **Benchmark**—a value that defines the desired state, or "good" for a solution in terms of a particular criterion.
- **Formula**—an expression of how changes in the value of the criterion affect the desirability of the possible solution. State the formula in comparative terms (for example, more is better) or absolute terms (for example, a night movement is better than a day movement).

<p><b>Short Title:</b> Cost</p> <p><b>Definition:</b> The maximum total cost of each truck.</p> <p><b>Unit of Measure:</b> Dollars</p> <p><b>Benchmark:</b> \$38,600</p> <p><b>Formula:</b> <math>\leq</math> \$38,600 is an advantage; <math>&gt;</math> \$38,600 is a disadvantage; less is better</p>
--

**Figure 2-2. Sample Evaluation Criterion**

2-43. A well-thought-out benchmark is critical for meaningful analysis. Analysis judges a solution against a standard, telling whether that solution is good in an objective sense. It differs from comparison, which judges possible solutions against each other telling us whether it is better, or worse in a relative sense. Benchmarks are the standards used in such analysis. They may be prescribed by regulations or guidance from the decision maker. Sometimes, the benchmark can be inferred by the tangible return expected from the problem's solution. Often, however, Army leaders establish benchmarks themselves. Four common methods for doing this are—

- **Reasoning**—the benchmark is based on personal experience and his or her judgment as to what would be good.
- **Historical precedent**—the benchmark is based on relevant examples of prior success.
- **Current example**—the benchmark is based on an existing condition, which is considered desirable.
- **Averaging**—the benchmark is based on the mathematical average of the solutions being considered. Averaging is the least preferred of all methods because it essentially duplicates the process of comparison.

2-44. In practice, the criteria by which choices are made are almost never of equal importance. Because of this it is often convenient to assign weights to each evaluation criterion. Weighting criteria establishes the relative importance of each one with respect to the others. Weighting should reflect the judgment of the decision maker or acknowledged experts as closely as possible. For example, a decision maker or expert might judge that two criteria are *equal* in importance, or that one criterion is *slightly favored* in importance, or *moderately* or *strongly favored*. If these verbal assessments are assigned numerical values, say from 1 to 4 respectively, mathematical techniques could be used to produce meaningful numerical criteria weights.

2-45. Additionally, pair wise comparison is an analytical tool that brings objectivity to the process of assigning criteria weights. In performing a pair wise comparison, the decision maker or expert methodically assesses each evaluation criterion against each of the others and judges its relative importance. A computer equipped with simple software easily performs the mathematical algorithms.

2-46. This process does not in any way diminish the importance of the decision maker's judgment. Rather it enables problem solvers to bring that judgment to bear with greater precision and in problems of greater complexity than might otherwise be possible. Regardless of the method used to assign criteria weights Army leaders state the rationale for each when recommending a solution to the decision maker.

## GENERATE POSSIBLE SOLUTIONS

2-47. After gathering information relevant to the problem and developing criteria, Army leaders formulate possible solutions. They carefully consider the guidance provided by the commander or their superiors, and develop several alternatives to solve the problem. Several alternatives should be considered, however too many possible solutions may result in wasted time on similar options. Experience and time available determine how many solutions to consider. Army leaders should consider at least two solutions. Doing this enables the problem solver to use both analysis and comparison as problem solving tools. Developing only one solution to “save time” may produce a faster solution, but risks creating more problems from factors not considered.

2-48. Army leaders follow two steps when developing solutions:

- Generate options.
- Summarize the solution in writing, sketches, or both.

### Generate Options

2-49. Creativity by Army leaders is key to developing effective solutions. Often, groups can be far more creative than individuals. However, those working on solutions should have some knowledge of or background in the problem area.

2-50. The basic technique for developing new ideas in a group setting is brainstorming. Brainstorming is characterized by unrestrained participation in discussion. Its rules include—

- State the problem and make sure all participants understand it.

- Appoint someone to record all ideas.
- Withhold judgment of ideas.
- Encourage independent thoughts.
- Aim for quantity, not quality.
- “Hitchhike” ideas—combine one’s thoughts with those of others.

2-51. At the conclusion of brainstorming, Army leaders may discard solutions that clearly do not approach the standards described by the screening criteria. If this informal screen leaves only one solution or none, then more options must be generated.

### **Summarize The Solution In Writing And Sketches**

2-52. After generating options, Army leaders accurately record each possible solution. The solution statement clearly portrays how the action or actions solve the problem. In some circumstances, the solution statement may be a single sentence (for example, “Purchase Model XYZ computers”). In other circumstance the solution statement may require more detail, including sketches or concept diagrams. For example, if the problem is to develop a multipurpose small-arms range, Army leaders may choose to portray each solution with a narrative and a separate sketch or blueprint of each proposed range.

## **ANALYZE POSSIBLE SOLUTIONS**

2-53. Having identified possible solutions, Army leaders analyze each one to determine its merits and drawbacks. If criteria are well defined, to include careful selection of benchmarks, analysis is greatly simplified.

2-54. Army leaders use screening criteria and benchmarks to analyze possible solutions. They apply screening criteria to judge whether a solution meets minimum requirements. For quantitative criteria, they measure, compute, or estimate the raw data values for each solution and each criterion. In analyzing solutions, which involve predicting future events, it is useful to have a process for visualizing those events. Wargaming, models, and simulations are examples of tools that can help problem solvers visualize events and estimate raw data values for use in analysis. Once raw data values have been determined, the Army leader judges them against applicable screening criteria to determine if a possible solution merits further consideration. A solution that fails to meet or exceed the set threshold of one or more screening criteria is screened out.

2-55. After applying the screening criteria to all possible solutions, they use benchmarks to judge them with respect to the desired state. Data values that meet or exceed the benchmark indicate that the possible solution achieves the desired state and thus is "good" with respect to that criterion. Data values that fail to meet the benchmark indicate a solution that is not good in terms of the identified criterion. For each solution, Army leaders list the respects in which analysis reveals it to be good or not good. It is quite possible for every possible solution being considered to fail to reach the benchmark, and so be considered not good in terms of a particular criterion. When this occurs, the Army leader has an obligation to point out to the decision maker that there are no good solutions under consideration in that

particular respect. Army leaders are careful not to compare solutions during analysis. To do so undermines the integrity of the process and tempts problem solvers to jump to conclusions. They examine each possible solution independently to identify its strengths and weaknesses. They are also careful not to introduce new criteria.

## **COMPARE POSSIBLE SOLUTIONS**

2-56. During this step, Army leaders compare each solution against the others to determine the optimum solution. Solution comparison identifies which solution best solves the problem based on the evaluation criteria. Army leaders use any comparison technique that helps reach the best recommendation. The most common technique is a decision matrix (see Chapter 3).

2-57. Quantitative techniques (such as decision matrices, select weights, and sensitivity analyses) may be used to support comparisons. However, they are tools to support the analysis and comparison. They are not the analysis and comparison themselves. The quantitative techniques should be summarized clearly so the reader need not refer to an annex for the results.

## **MAKE AND IMPLEMENT THE DECISION**

2-58. After completing their analysis and comparison, Army leaders identify the preferred solution. For simple problems, Army leaders may proceed straight to executing the solution. For more complex problems, a leader plan of action or formal plan may be necessary (see FM 22-100). If a superior assigned the problem, Army leaders prepare the necessary products (verbal, written, or both) needed to present the recommendation to the decision maker. Before presenting findings and a recommendation, Army leaders coordinate their recommendation with those affected by the problem or the solutions. In formal situations, Army leaders present their findings and recommendations to the decision maker as staff studies, decision papers, or decision briefings (see Annex A and Annex B).

2-59. A good solution can be lost if the Army leader cannot persuade the audience that it is correct. Every problem requires both a solution and the ability to communicate it. The writing and briefing skills an Army leader possesses may ultimately be as important as good problem solving skills.

2-60. Based on the decision maker's decision and final guidance, Army leaders refine the solution and prepare necessary implementing instructions. Formal implementing instructions can be issued as a memorandum of instruction, policy letter, or command directive. Once Army leaders have given instructions, Army leaders monitor their implementation and compare results to the criteria of success and the desired end state established in the approved solution. When necessary, they issue additional instructions.

2-61. A feedback system that provides timely and accurate information, periodic review, and the flexibility to adjust must also be built into the implementation plan. Army leaders stay involved, and are careful not to create new problems because of uncoordinated implementation of the solution.

2-62. Army problem solving does not end with identifying the best solution or obtaining approval of a recommendation. It ends when the problem is solved.

## Chapter 3

# Military Decision Making Process

*A good plan violently executed NOW is better than a perfect plan next week.*

General George S. Patton Jr.

The military decision making process (MDMP) is an established and proven analytical planning process. It is an adaptation of Army problem solving as discussed in Chapter 2. This chapter describes the steps of the MDMP and explains how commanders, staffs, and subordinate headquarters interact during planning. Additionally, this chapter offers ways to shorten the process when planning in a time-constrained environment. Formats for staff estimates are located in Appendix E. Formats for plans and orders are located in Appendix G.

## BACKGROUND

3-1. **The military decision making process is a planning tool that establishes procedures for analyzing a mission, developing, analyzing, and comparing courses of action against criteria of success and each other, selecting the optimum course of action, and producing a plan or order.** The MDMP applies across the spectrum of conflict and range of military operations. Commanders with an assigned staff use the MDMP to organize their planning activities, share a common understanding of the mission and commander's intent, and develop effective plans and orders.

3-2. The MDMP helps organize the thought process of commanders and staffs. It helps them apply thoroughness, clarity, sound judgment, logic, and professional knowledge to reach decisions. The shaded boxes in Figure 3-1

CONTENTS	
Background .....	3-1
Commander's Role in Planning .....	3-4
Staff's Role in Planning .....	3-9
Commander, Staff, and Subordinate Interaction .....	3-10
Performing the Military Decision Making Process .....	3-11
Receipt of Mission .....	3-12
Mission Analysis .....	3-15
Course of Action Development .....	3-27
Course of Action Analysis (War-Gaming) .....	3-37
Course of Action Comparison .....	3-48
Course of Action Approval .....	3-49
Orders Production .....	3-52
Planning in a Time-Constrained Environment .....	3-53
The Commander's Role .....	3-54
The Staff's Role .....	3-55
Time-Saving Techniques .....	3-55

depict the seven steps of the MDMP. Each step begins with inputs that build on previous steps. The outputs of each step drive subsequent steps. Errors committed early affect later steps. While the formal process begins with the receipt of a mission and has as its goal the production of an order, planning continues throughout the operations process.

3-3. Preparation and execution, while not part of the MDMP, are shown in the lower portion of Figure 3-1 to highlight the importance of continuous planning. Once a plan or order is produced, it is transmitted to those who will execute it quickly enough for them to produce their own plans and prepare for the operation. Backbriefs and rehearsals occur during preparation. They are essential to ensure those responsible for execution have a clear understanding of the mission, commander's intent, and concept of operations. (See FM 6-0 for a detailed discussion on rehearsals.) During execution, plans are refined or planning for a new operation begins, as the situation requires. Assessment is continuous and occurs during planning, preparation, and execution. At any time during the operations process, the situation may require the commander to restart the MDMP. Examples of these circumstances include—

- The commander receives a new mission.
- The commander receives or perceives a possible follow-on mission.
- The commander receives or perceives a contingency based on a variance in the current operation.

3-4. The MDMP can be as detailed as time, resources, experience, and situation permit. The MDMP is detailed, deliberate, sequential, and time-consuming. All steps and sub-steps are used when enough planning time and staff support are available to thoroughly examine two or more friendly and enemy course of actions (COAs). This typically occurs when developing operation plans (OPLANs), when planning for an entirely new mission, or during training designed to teach the MDMP.

3-5. Commanders can alter the MDMP to fit time-constrained circumstances and produce a satisfactory plan (see paragraphs 3-202 to 3-239). In time-constrained conditions, commanders assess the situation; update their commander's visualization, and direct the staff to perform those MDMP activities needed to support the required decisions. Streamlined processes permit commanders and staffs to shorten the time needed to issue orders when the situation changes. In a time-constrained environment, many steps of the MDMP are conducted concurrently. To an outsider, it may appear that experienced commanders and staffs omit key steps. In reality, they use existing products or perform steps in their heads instead of on paper. They also use many shorthand procedures and implicit communication. Fragmentary orders (FRAGOs) and warning orders (WARNOs) are essential in this environment.

3-6. The full MDMP provides the foundation on which planning in a time-constrained environment is based. Before a staff can effectively abbreviate the MDMP, it must master the steps of the full MDMP. The advantages of using the full MDMP are—



**Military Decision Making Process (Final Approved Draft)**

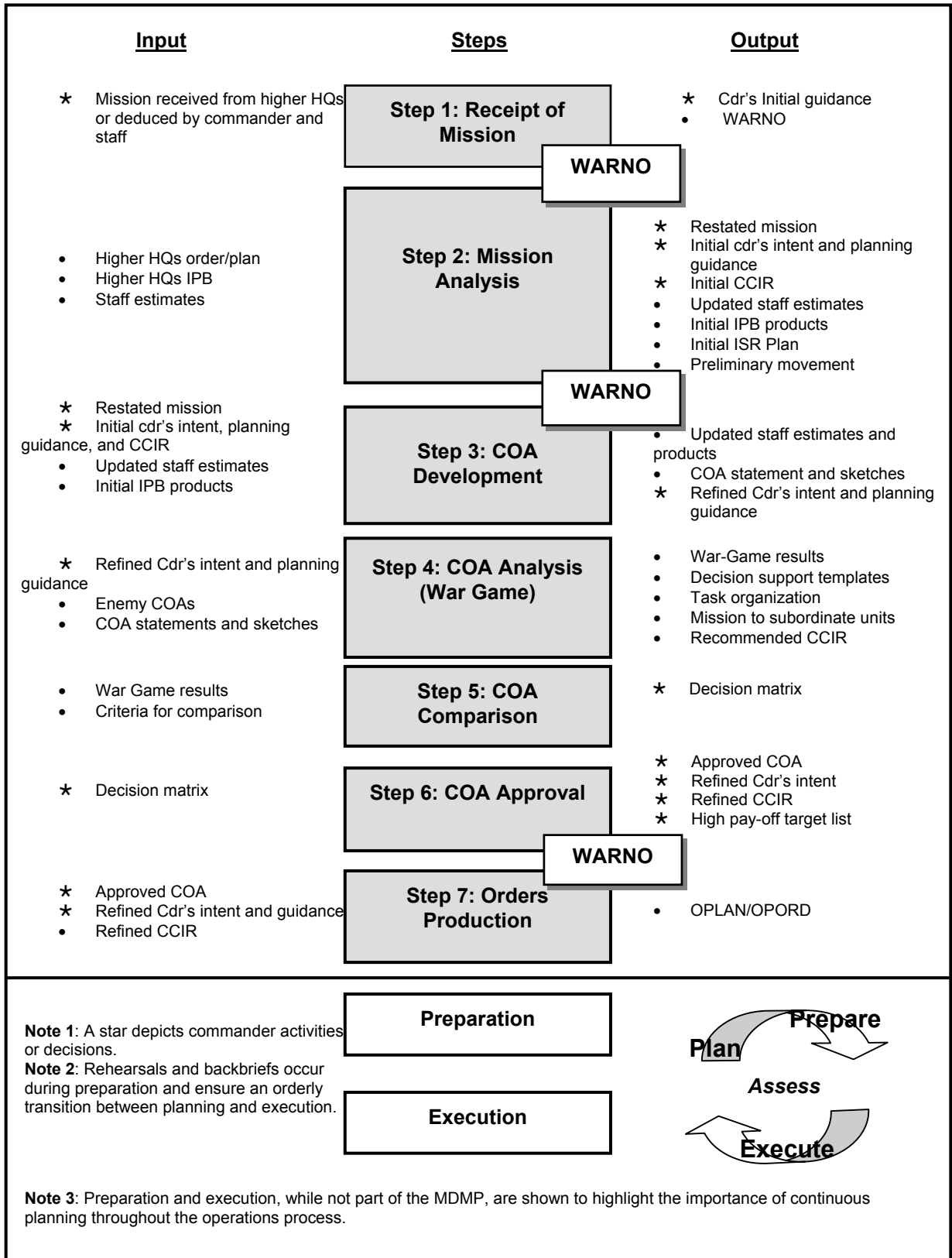

**Figure 3-1. The Military Decision Making Process**

- It analyzes and compares multiple friendly and enemy COAs to

identify the best possible friendly COA.

- It produces the greatest coordination and synchronization in plans and orders.
- It minimizes the chance of overlooking critical aspects of the operation.
- It helps identify contingencies for branch and sequel development.

3-7. The disadvantage of using the full MDMP is that it is time-consuming. The longer the higher headquarters spends planning, the less time for subordinates to plan, prepare, and execute operations. Additionally, more time devoted to planning versus preparation and execution can allow enemies to improve their posture. This may lead to yielding the initiative, resulting in a loss of momentum or lost opportunities for the friendly force.

## COMMANDER'S ROLE IN PLANNING

3-8. Commanders are in charge of the planning process. From start to finish, their personal role is central. They discipline the staff to meet the requirements of time, planning horizons, simplicity, and level of detail. They also discipline the product to ensure it is relevant to the moment and suitable to subordinates. Commanders do this by visualizing, describing, and directing operations (see FM 6-0).

### Visualize

3-9. *Commander's visualization* is the mental process of achieving a clear understanding of the force's current state with relation to the enemy and environment (situational understanding), and developing a desired end state that represents mission accomplishment and the key tasks that move the force from its current state to the end state (commander's intent) (FM 6-0). Commander's visualization begins in planning and continues throughout the operations process until the force accomplishes the mission.

3-10. After receiving a mission, commanders develop their initial commander's visualization. During mission analysis, they visualize an operational framework by defining and arranging its three components—area of operations (AO), battlespace, and battlefield organization (see FM 3-0). The operational framework helps commanders visualize the arrangement of friendly forces and resources in time, space, and purpose with respect to each other, the enemy or situation. They consider the factors of mission, enemy, terrain and weather, troops and support available, time available, and civil considerations (METT-TC), staff estimates, input from other commanders, experience, and judgment to develop situational understanding. From this situational understanding, commanders determine the desired end state and develop a construct of how to get their organization from its current position to that desired end state.

### Describe

3-11. During the MDMP, commanders describe their commander's visualization through the commander's intent, planning guidance, and commander's critical information requirements (CCIR). Commanders describe an operation in terms suited to their experience and nature of the mission. They use an operational framework and the elements of operational

design to describe the relationship of decisive, shaping, and sustaining operations to time and space (see FM 3-0). They emphasize how the combination of decisive, shaping, and sustaining operations relates to accomplishing the purpose of the overall operation.

3-12. The elements of operational design are tools that help commanders visualize operations and shape their intent. They provide commanders a framework to conceptually link ends, ways, and means. While the elements of operational design give commanders a framework to think about operations, their usefulness and applicability diminishes at each lower echelon. For example, a corps commander may consider all the elements of operational

### Elements of Operational Design

- End state and military conditions
- Center of gravity
- Decisive points and objectives
- Lines of operation
- Culminating point
- Operational reach, approach, and pauses
- Simultaneous and sequential operations
- Linear and nonlinear operations
- Tempo

design, while a brigade commander may focus his visualization on decisive points, objectives, and tempo. A battalion commander may focus on a decisive point and objectives. See FM 3-0 for a full discussion on the fundamentals of full-spectrum operations, to include the elements of operational design.

3-13. **Commander's Intent.** A clear, concise statement of what the force must do and the conditions the force must meet to succeed with respect to the enemy, terrain, and the desired end state (FM 3-0). It is the statement describing the commander's visualization that focuses effort throughout the operations process.

3-14. During planning, the commander's intent drives the MDMP. The staff uses it to develop COAs that conform to how the commander wants to achieve the end state. During execution, the commander's intent enables subordinates' initiative by setting limits beyond the established plan or order while retaining unity of effort. Subordinates use these expanded limits for solutions when deciding how to act when facing unforeseen opportunities and threats, and in situations where the concept of operations no longer applies.

3-15. The commander's intent links the mission and concept of operations. It describes the end state and key tasks that, along with the mission, are the basis for subordinates' initiative. Commanders may also use the commander's intent to explain a broader purpose beyond that of the mission statement. The mission and the commander's intent must be understood two echelons down.

3-16. The components of the commander's intent include:

- End state.
- Key tasks.
- Expanded purpose (if desired).

3-17. **End State.** At the operational and tactical levels, an end state consists of those conditions that, when achieved, accomplish the mission. At the

operational level, these conditions attain the aims set for the campaign or major operation (FM 3-0). Commanders normally articulate an operation's end state by the relationship between friendly forces and the enemy, terrain, and the population.

3-18. **Key Tasks.** Those tasks that the force must perform as a whole or the conditions the force must meet to achieve the end state and stated purpose of the operation. Key tasks are not tied to a specific COA; rather, they identify what the force must do to achieve the end state (FM 6-0). Acceptable COAs accomplish all key tasks. In changed circumstances—when significant opportunities present themselves or the concept of operations no longer fits the situation—subordinates use key tasks to keep their efforts focused on achieving the commander's intent. Examples of key tasks include terrain that must be controlled, the operation's tempo and duration, and the operation's effect on the enemy. Key tasks are not specified tasks for any subordinate unit; however, they may be sources of implied tasks.

3-19. **Expanded Purpose.** If the commander's intent addresses purpose, it does not restate the "why" of the mission statement. Rather, it addresses the broader operational context of the mission.

3-20. The commander's intent does not state the method the force will use to achieve the end state. Method is included in the concept of operations. Nor does the commander's intent include acceptable risk. Risk is stated in the commander's planning guidance and is incorporated into all COAs. Figure 3-2 depicts how the commander's intent focuses planning. Planners incorporate key tasks into all COAs and ensure the COAs achieve the end state for the operation.

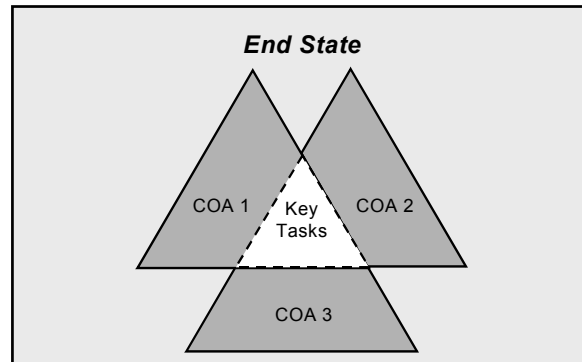

Figure 3-2. Commander's Intent and COA Development

3-21. **Planning Guidance.** Commanders develop planning guidance for the staff from the commander's visualization. Planning guidance may be as broad or detailed as circumstances require. However, it must convey to the staff the essence of the commander's visualization. Commanders use their experience and judgment to add depth and clarity to the planning guidance. They ensure the staff understands the broad outline of the commander's visualization, while still permitting the necessary latitude for the staff to explore different options. Commanders may, for example, identify decisive points and describe how they envision the concentration of combat power against each (see Appendix D).

3-22. Planning guidance initially focuses on COA development and on intelligence, surveillance, and reconnaissance (ISR) operations. Commanders

issue detailed ISR guidance early (during mission analysis or immediately afterwards) and begin ISR operations as soon as possible. Following mission analysis, planning guidance focuses on COA development, analysis, and comparison, with particular attention to the key tasks. It states in broad terms when, where, and how the commander intends to employ combat power in the decisive operation to accomplish the mission within the higher commander's intent. Planning guidance contains priorities for the battlefield operating systems. It also includes how the commander visualizes shaping and sustaining operations contributing to the concept of operations.

3-23. The amount of detail in the planning guidance depends on the time available, the staff's proficiency, and the latitude the higher commander allows. Broad and general guidance gives the staff maximum latitude; it lets proficient staffs develop flexible and effective options. More constrained conditions require planning guidance to be more specific and directive. The more detailed the guidance, the more quickly the staff can complete the plan. However, this approach risks overlooking or insufficiently examining things that might affect mission execution.

3-24. When commanders identify one or more decisive points, or an operation they consider decisive, they tell the staff. Decisive points exist where an enemy weakness allows maximum combat power to be applied. A decisive point is not an end state; it is a time, event, or location where the force can achieve decisive results leading to mission accomplishment. Commanders can describe it verbally, with a sketch, or on a map. The description shows how the commander visualizes the array of forces at the decisive point, the expected effects on the enemy, and how these effects lead to mission accomplishment.

3-25. **Commander's Critical Information Requirements.** Elements of information required by commanders that directly affect decision making and dictate the successful execution of military operations (FM 3-0). CCIR result from the analysis of information requirements (IR) in the context of the mission and commander's intent. Commanders limit CCIR to a useable number (usually ten or less) for comprehension. Commanders designate them to let their staffs and subordinates know what information they deem necessary for decision making. Some CCIR may support one or more decision points. In all cases, the fewer the CCIR, the better the staff can focus its efforts and allocate scarce resources.

3-26. CCIR belong to the commander alone. Commanders decide what IRs are critical, based on their individual cognitive abilities and commander's visualization. Staffs recommend CCIR based on mission analysis during planning and through assessment during preparation and execution of operations. They keep the number of recommended CCIR to a minimum.

3-27. CCIR are not static. Commanders add, delete, adjust, and update them throughout an operation based on the information they need for decision making. CCIR are—

- Specified by the commander for each operation.
- Applicable only to the commander who specifies them.
- Situation-dependent—directly linked to current and future missions.
- Focused on predictable events or activities.

- Time-sensitive. Answers to CCIR must be immediately reported to the commander by any means available.
- Always established by an order or plan. During planning, CCIR are established by WARNO. During preparation and execution, changes to CCIR are disseminated by FRAGO.

3-28. CCIR are key elements of information commanders required to support decisions they anticipate. CCIR also help screen the type and amount of information reported directly to the commander. During planning, CCIR focus on information needed to determine which COA to choose. During preparation and execution, CCIR focus on information needed to validate the selected COA or determine when to initiate critical events, such as a branch or sequel. CCIR may include latest time information of value (LTIOV) to indicate time sensitivity.

3-29. CCIR include priority intelligence requirements (PIR) and friendly forces information requirements (FFIR). CCIR must be focused enough to generate relevant information. Unfocused requests, such as “I need to know if the enemy moves,” may provide data but not much useable information. However, “I need to know when the enemy lead brigade reached named Area of Interest 2” or I need to know if multinational unit on our right flank advances beyond Phase Line Blue” are example of CCIR specific enough to focus collection and information management priorities.

- *Priority intelligence requirements* are those intelligence requirements for which a commander has an anticipated and stated priority in his task of planning and decision making (JP 1-02). PIRs identify the information the commander considers most important for decision making. They concern both the enemy (including the time available to the enemy) and the environment (terrain, weather, and some civil considerations).
- *Friendly forces information requirements* are information the commander and staff need about the forces available for the operation (FM 6-0). FFIR consist of information on the mission, troops and support available, and time available for friendly forces.

3-30. **Essential Elements Of Friendly Information.** *Essential elements of friendly information* (EEFI) are critical aspects of a friendly operation that, if known by the enemy, would subsequently compromise, lead to failure, or limit success of the operation, and therefore must be protected from enemy detection (FM 3-13). Although EEFI are not part of CCIR, they become a commander’s priorities when he states them. EEFI help commanders understand what enemy commanders want to know about friendly forces and why. They tell commanders what cannot be compromised. For example, a commander may determine if the enemy discovers the movement of the reserve, the operation is at risk. In this case, the location and movement of the reserve become EEFI.

3-31. EEFI provide a basis for indirectly assessing the quality of the enemy’s situation understanding: if the enemy does not know an element of EEFI, it degrades his situational understanding. Just as CCIR are the basis for allocating collection assets to answer questions, EEFI are the basis for the

command's operations security (OPSEC) plan. When limited assets are available for OPSEC, the first priority goes to protecting EEFI.

## Direct

3-32. Commanders direct throughout the operations process. Their directions take different forms during planning, preparation, and executions. During planning, commander guide their staff during the MDMP, preparing mission orders, and establishing control measures.

3-33. During the MDMP, commanders direct when they select a COA and communicate that decision to subordinates in a plan or order. They or their staff analyzes each possible COA for suitability, feasibility, and acceptability to select COAs for further analysis. After COA analysis and COA comparison using screening and evaluation criteria developed during MDMP, commanders select or approve the COA. Commanders also direct when they issue and revise planning guidance.

## STAFF'S ROLE IN PLANNING

3-34. The staff's effort during planning focuses on helping the commander make decisions and developing effective plans and orders. It does this by integrating information with sound doctrine and technical competence. The chief of staff (COS)/executive officer (XO) manages, coordinates, and disciplines the staff's work, and provides quality control. The COS or XO must clearly understand the commander's guidance and intent because they supervise the entire process. They provide time lines to the staff, establish brief-back times and locations, and provide any instructions necessary to complete the plan.

3-35. Staff activities during planning initially focus on mission analysis. Mission analysis develops information to help the commander understand the situation and mission. During COA development and COA comparison, the staff provides tactically sound recommendations to support the commander in selecting a COA. After the commander makes a decision, the staff prepares the plan or order, coordinating all necessary details. The staff performs the following critical tasks during planning:

- Develop and maintain their staff estimate.
- Identifying specified and implied tasks.
- Identifying constraints.
- Identifying key facts and assumptions.
- Performing intelligence preparation of the battlefield (IPB).
- Formulating the concepts of operations and support in line with the commander's intent.
- Developing the scheme of maneuver to support the COA.
- Preparing, authenticating, and distributing their portion of the plan or order, annexes, estimates, appendixes, and supporting plans.

3-36. Throughout planning, staff officers prepare recommendations within their functional areas, such as—

- Unit, system, weapons, and munitions capabilities, limitations, and employment.

- Risk identification and mitigation.
- Organization for combat, allocations to subordinate units, and command and support relationships among subordinate units.
- Resource allocation and employment synchronization of organic and supporting assets (including those of other services).
- General locations and movements of units.

3-37. Staff sections prepare and continuously update estimates to help the commander make decisions. **A *staff estimate* is an assessment of the situation and an analysis of those courses of action a commander is considering that best accomplishes the mission. It includes an evaluation of how factors in a staff section's functional area influence each COA and includes conclusions and a recommended COA to the commander.** The staff estimate is a continuous process that evaluates current and future operations to determine if a current operation is proceeding according to plan and if future operations are supportable. Staff estimates are used to support the decision-making process during planning and execution.

3-38. The staff estimate format parallels the steps of the MDMP and serves as the primary tool for recording a staff section's assessments, analyses, and recommendations (see Appendix E). Staff estimates contain a compilation of critical factors the staff tracks, plus an analysis of other sections' actions that impact their functional area. Adequate plans hinge on early, accurate, and continuous staff estimates. The commander uses recommendations from them to select feasible COAs for analysis and decide which COA to execute. Failure to make or update staff estimates may lead to mistakes throughout an operation.

3-39. Staff estimates are continuous. They are maintained throughout the operations process—not just during planning. Once the commander has decided on a COA, the staff estimate transitions to an assessment tool called a running estimate. A *running estimate* is a staff estimate, continuously updated based on new information as the operation proceeds (FM 6-0). It is a staff technique that supports commander's visualization and decision making during preparation and execution of operations. In running estimates, staffs continuously update their conclusions and recommendations based on the impact of new facts. The updated conclusions and recommendations make running estimates useful in assessing operations. Staff sections provided these updated conclusions and recommendations to the command as required, either by the situation or the commander.

## COMMANDER, STAFF, AND SUBORDINATE INTERACTION

3-40. The MDMP is designed to facilitate interaction between the commander, staff, and subordinate headquarters throughout planning (see Figure 3-3). This interaction allows for a concurrent, coordinated effort that maintains flexibility, efficiently uses time, and facilitates continuous information sharing. Internally, this interaction allows the staff to receive guidance from the commander and resolve issues as they arise. Additionally, it provides a structure for the staff to work collectively and produce a coordinated plan.



3-41. Commander's actions are listed under the commander's visualization column in Figure 3-3. The right column lists a series of briefings the staff gives to the commander. (The operation order [OPORD] briefing is presented to subordinate commanders.) These briefings allow the staff to present their analysis and recommendations in a coordinated manner and receive guidance throughout the planning process.

3-42. The MDMP is also designed to allow the staff to interact and share information with subordinate headquarters during planning. As decisions, information, and staff products become available, the higher headquarters sends them to subordinates in WARNOs. Timely WARNOs facilitate parallel planning, allow subordinates to start necessary movements, and direct ISR operations. While Figure 3-3 depicts three WARNOs, the situation dictates the number of WARNOs required.

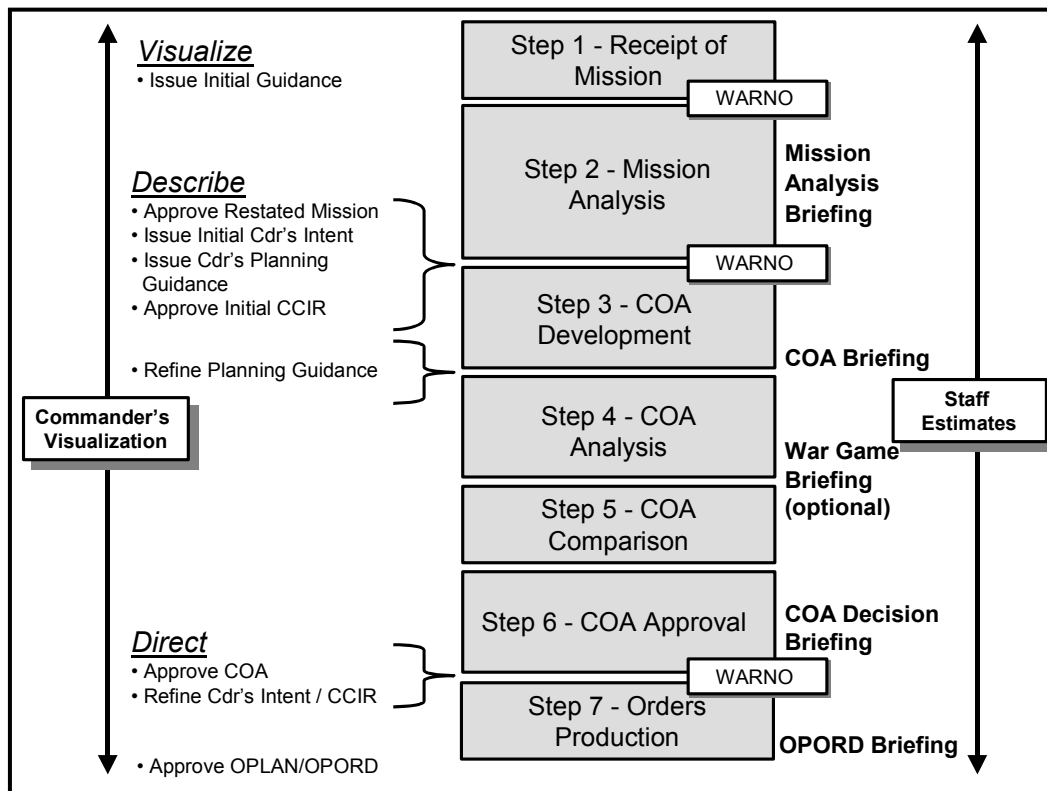

Figure 3-3. The Role of the Command and Staff in the MDMP

## PERFORMING THE MILITARY DECISION MAKING PROCESS

3-43. The MDMP consists of the seven steps shown in Figures 3-1 and 3-3. The commander and staff perform these steps sequentially; however, there may not be distinct points at which one step ends and another begins. For example, IPB (a mission analysis task) continues throughout the MDMP. It is convenient to describe the MDMP in terms of steps; nonetheless, planners

compare the process to current requirements, set priorities, and perform the necessary tasks in an order that produces the required product on time.

3-44. The MDMP synchronizes several processes to include—

- IPB (see FM 34-130).
- The targeting process (see FM 6-20-10).
- Risk management (see FM 100-14).

The following discussion shows where these processes provide input to the overall MDMP. All of them proceed concurrently.

### RECEIPT OF MISSION

3-45. The MDMP begins with receiving or anticipating a new mission. This can come from an order issued by higher headquarters or be derived from an ongoing operation. For example, the commander may determine—based on a change in enemy dispositions, friendly force dispositions, or other battlefield factors—that there is an opportunity to accomplish the higher commander’s intent by a means different from the original concept of operations. When a new mission is identified, commanders and staffs perform the process actions and produce the outputs shown in Figure 3-4.

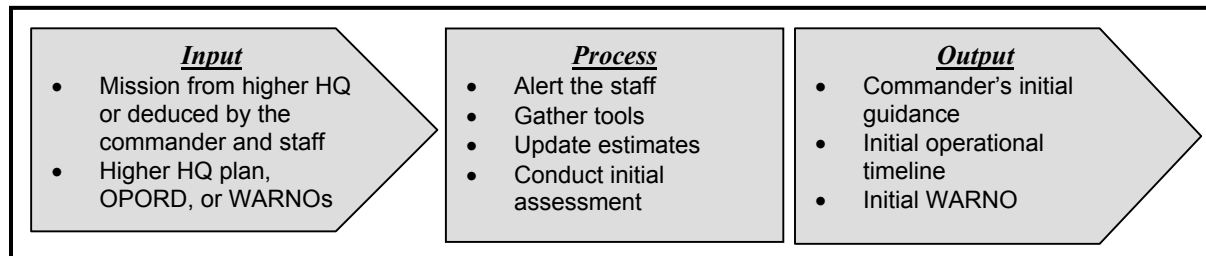

Figure 3-4. Receipt of Mission

### Alert the Staff

3-46. As soon as a unit receives a new mission, the operations section alerts the staff of the pending planning requirement. Unit standing operating procedures (SOPs) identify who participates in mission analysis, who the alternates are, and where they should assemble. Supporting and attached units obtain and review the unit SOP to ensure they understand their responsibilities. If the commander wants to use collaborative planning, participants from subordinate units are also notified.

### Gather the Tools

3-47. The staff prepares for mission analysis by gathering the tools needed to perform it. These tools include, but are not limited to—

- The higher headquarters order or plan and operational graphics. (When possible, each staff section receives a copy of the higher headquarters base order or plan, task organization, their functional annexes, and a copy of the operational graphics.)
- Maps of the area of operations (AO).

- Both their own and the higher headquarters' SOPs.
- Appropriate field manuals (especially FM 1-02).
- Current staff estimates.
- Other materials and products required.

Staff sections should develop a list of requirements for each type of mission.

### **Update Staff Estimates**

3-48. While gathering the necessary tools for planning, each staff section begins updating its estimate—especially the status of friendly units and resources. While this task is listed at the beginning of the MDMP, developing and updating staff estimates is continuous throughout the operations process. During planning, staff members monitor, track, and aggressively seek information important to their functional area. They assess how this information affects COA development and any recommendations they make. After the plan is approved, staff officers continue to monitor the situation and update their estimates in the form of running estimates. They pay particular attention to how new information or events affect recommendations and evaluations made during their initial estimate.

### **Perform an Initial Assessment**

3-49. The commander and staff perform a quick initial assessment. This assessment includes determining the—

- Time available from mission receipt to mission execution.
- Time needed to plan and prepare for the mission, for both the headquarters and subordinate units.
- Current IPB and other intelligence products available.
- Staff estimates already current and those that need updating.
- Time required to position critical elements—to include command and control (C2) nodes—for the upcoming operation.
- The staff's experience, cohesiveness, and level of rest or stress.

This assessment is designed to optimize the command's use of time while preserving time for subordinate commanders to plan and prepare for operations.

3-50. A critical product of this assessment is the initial operational time line. This time line includes allocation of available time for planning, preparing, and executing the operation. The commander and staff balance the desire for detailed planning against the time available to plan and prepare. Commanders generally allocate a minimum of two-thirds of the available time to subordinate units for planning and preparation. This leaves one-third of the time for the commander and staff to do their own planning (see Chapter 1). The operational time line is refined during mission analysis and continuously updated.

3-51. An important component of the operational time line is the staff planning time line. The chief of staff/executive officer or a representative outlines how long the staff can spend on each MDMP step. The planning time line indicates when certain products are due and to whom. It includes times

and locations for meetings and briefings. It serves as a benchmark for the commander and staff throughout the planning process.

3-52. Table 3-1 (page 3-14) depicts a generic planning time line for a division. It shows how much time can be devoted to each MDMP step, based on the time between receipt of mission and execution. This sample time line is based on the one-third/two-thirds rule, and uses the following percentages to determine the amount of time allocated to each step:

- Mission analysis 30%
- COA development 20%
- COA analysis/comparison/decision 30%
- Orders production 20%

3-53. The “R” in table 3-1 represents receipt of mission time. All R + times represent the time that the action should be completed. For example, given 48 hours to plan and prepare for a mission, mission analysis should be complete by 4 hours, 48 minutes after the mission is received. Unit SOPs should contain generic planning time lines to help decision makers develop the staff planning time line. Generic time lines serve as guides and are adjusted based on METT-TC.

	Time Available Before Execution									
	8 hrs		24 hrs		48 hrs		72 hrs		96 hrs	
	Time For	R +	Time For	R +	Time For	R +	Time For	R +	Time For	R +
<b>Mission Analysis</b>	0:45	0:45	2:24	2:24	4:48	4:48	7:12	7:12	9:36	9:36
<b>COA Development</b>	0:30	1:15	1:36	4:00	3:12	8:00	4:48	12:00	6:24	16:00
<b>COA Analysis/ Comparison/ Decision</b>	0:45	2:00	2:24	6:24	4:48	12:48	7:12	19:12	9:36	25:36
<b>Orders Production</b>	0:30	2:30	1:36	8:00	3:12	16:00	4:48	24:00	6:24	32:00
<b>Total Time Used</b>	2:30		8:00		16:00		24:00		32:00	

**Table 3-1. Generic Planning Time Line for a Division**

**Issue the Initial Guidance**

3-54. Once time is allocated, the commander determines whether to use the full MDMP or to abbreviate the process. Time, more than any other factor, determines the detail to which the staff can plan. The commander then issues the initial guidance (not to be confused with mission analysis task 15—Issue the Commander’s Planning Guidance). Although brief, the initial guidance includes—

- The initial operational time line.
- How to abbreviate the MDMP, if required.
- Necessary coordination to perform, including liaison officers to dispatch.
- Authorized movement (to include positioning of C2 system nodes).
- Additional staff tasks, to include specific information requirements.
- Collaborative planning times and locations (if desired).
- Initial IR or CCIR (as required).

### Issue the Initial Warning Order

3-55. The last task in receipt of mission is to issue a WARNO to subordinate and supporting units. This order includes, as a minimum—

- The type of operation.
- The general location of the operation.
- The initial operational time line.
- Any movements to initiate.
- Any collaborative planning sessions directed by the commander.
- Initial IR or CCIR.
- ISR tasks.

### MISSION ANALYSIS

3-56. A thorough mission analysis is crucial to planning. Both the process and products of mission analysis help commanders refine their situational understanding and determine their mission. Accurate situational understanding enables them to better visualize the operation. Mission analysis consists of 17 tasks, not necessarily sequential (see Figure 3-5). In addition to the staff's mission analysis, commanders perform their own mission analysis. This gives them a frame of reference to assess the staff's work and develop their visualization. The staff uses running estimates to record assessments and other information. Anticipation, prior preparation, and a trained staff are the keys to a timely mission analysis.

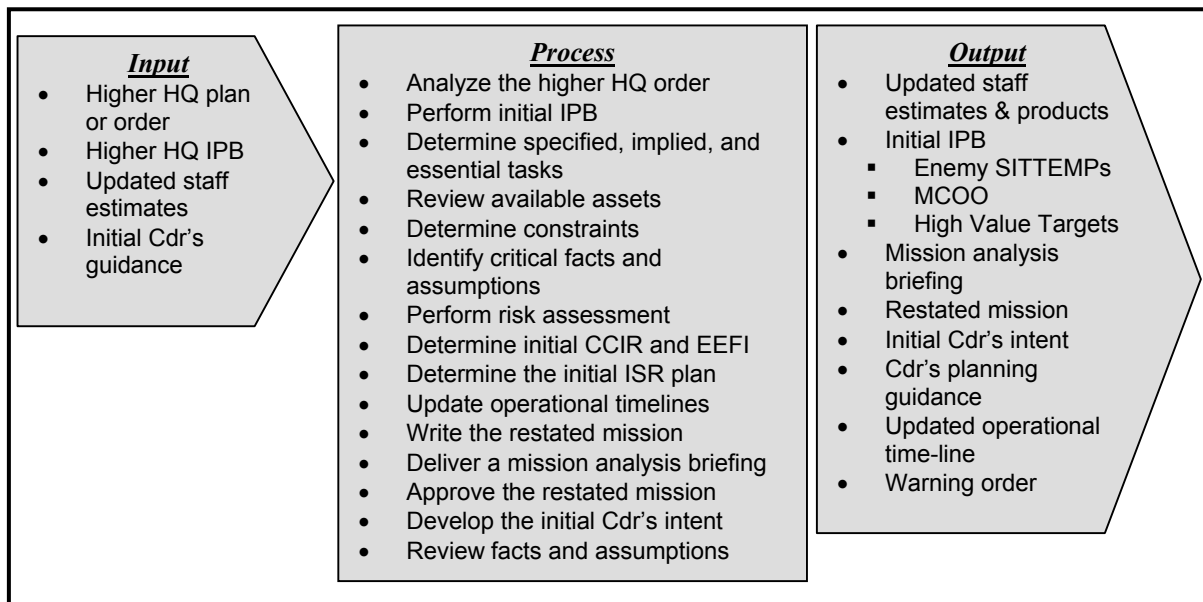

Figure 3-5. Mission Analysis

#### Task 1. Analyze the Higher Headquarters Order

3-57. Commanders and staffs thoroughly analyze the higher headquarters order to establish where the unit mission fits into the missions of higher and adjacent headquarters. Their goal is to determine how their unit, by task and purpose, contributes to the mission, commander's intent, and concept of

operations of the higher headquarters to levels up. They also determine how their mission and those of adjacent units contribute to achieving the commander's intent. The commander and staff seek to completely understand—

- The higher headquarters—
  - Commander's intent.
  - Mission.
  - Available assets.
  - Area of operations (AO).
  - Concept of operations.
  - Operational time-line.
- The missions of adjacent (including front and rear), supporting, and supported units, and their relation to higher headquarters plan.
- The unit AO.
- Their mission in the context of and in relation to the higher headquarters mission and commander's intent.

Parallel and collaborative planning with the higher headquarters facilitates this task.

3-58. When staffs misinterpret the higher headquarters mission, commander's intent, or guidance, time is wasted. If confused by the higher headquarters order or guidance, the staff seeks clarification immediately. Liaison officers familiar with the higher headquarters plan can assist by attending and participating in planning. Staffs may also use requests for information to clarify or obtain additional information from a unit over which they do not have tasking authority, such as adjacent units.

## **Task 2. Perform Initial Intelligence Preparation of the Battlefield**

3-59. *Intelligence preparation of the battlefield* is the systematic, continuous process of analyzing the threat and environment in a specific geographic area. IPB is designed to support the staff estimate and military decision making process. Most intelligence requirements are generated as a result of the IPB process and its interrelation with the decision making process. (FM 34-130) IPB products support the commander and staff and are essential to estimates, targeting, and decision making.

3-60. IPB is an analytical methodology employed as part of intelligence planning to reduce uncertainties concerning the enemy, environment, and terrain for all types of operations. IPB is conducted during mission planning to support the commander's decision making and to form the basis for the direction of intelligence operations in support of current and future missions. It utilizes existing databases and identifies gaps in intelligence needed to determine the impact of the enemy, environment, and terrain on operations and presents this in an appropriate form to facilitate operational planning. It forms the basis for situation development.

3-61. The G-2/S-2 leads the staff through the IPB process. Staff officers must assist the G-2/S-2 in developing IPB products to include the situational template (SITTEMP) within their own areas of expertise or functional area. IPB starts during mission analysis, is refined during the rest of the MDMP,

and continues during preparation and execution of operations. IPB consists of four steps:

- **Define the Battlefield Environment.** Defining the battlefield environment includes identifying characteristics that influence friendly and threat operations. It helps determine the area of interest (AI) and identifies gaps in intelligence.
- **Describe the Battlefield's Effects.** Describing the battlefield's effects involves evaluating all aspects of the environment. These include the effects of terrain, weather, and some civil considerations in the AO. Describing the battlefield's effects identifies constraints on potential friendly COAs and may reveal implied tasks. It also identifies opportunities the battlefield environment presents, such as avenues of approach and engagement areas. The staff integrates these into their staff estimates and potential friendly COAs.
- **Evaluate the Threat.** Evaluating the threat involves analyzing intelligence to determine how adversaries normally organize for combat and conduct operations under similar circumstances. This step results in a doctrinal template that depicts how the threat operates when unconstrained by effects of the environment. Knowing enemy capabilities and vulnerabilities allows the commander and staff to make assumptions about the relative capabilities of friendly forces. In some instances, historical or pattern analysis data may not be available. The staff would not produce a doctrinal template but would develop a SITTEMP based on available intelligence and military judgment.
- **Determine Threat Courses of Action.** Using the results of the previous steps, the intelligence officer determines possible threat COAs. They are expressed as situation templates (SITTEMPS) that include all combat multipliers the enemy could use. SITTEMPS are done before the mission analysis briefing and are used to brief the commander on likely enemy COAs. The intelligence officer continues to develop and war-game these threat COAs during COA analysis.

3-62. The results of the initial IPB are the modified combined obstacle overlay (MCOO), enemy SITTEMPS, and high value target list (HVTL). Additionally, the initial IPB identifies gaps in information that the commander uses to establish initial PIR. These are incorporated into the initial ISR plan (see mission analysis task 9—Determine the Initial ISR Plan).

3-63. The intelligence officer, with staff assistance, develops initial event templates from the SITTEMPS. Event templates are not required for the mission analysis briefing; however, they should be done before COA development. Event templates help identify where specific enemy activities may occur, the most likely enemy COA, and the most dangerous enemy COA. Additionally, IPB identifies high-value targets (HVTs) as a part of the targeting process. The targeting process is integrated with the MDMP (see Appendix H).

### Tasks 3. Determine Specified, Implied, and Essential Tasks

3-64. The staff analyzes the higher headquarters order and the higher commander's guidance to determine specified and implied tasks. A *task* is a clearly defined and measurable activity accomplished by individuals and organizations (FM 7-0). In the context of operations, a *task* is a clearly defined and measurable activity accomplished by Soldiers, units, and organizations that may support or be supported by other tasks. The "what" of a mission statement is always a task. From the list of specified and implied tasks, the staff determines essential tasks for inclusion in the unit's mission statement.

3-65. ***Specified tasks*** are tasks specifically assigned to a unit by its higher headquarters. Paragraphs 2 and 3 of the higher headquarters order or plan state specified tasks. Combat support (CS) and combat service support (CSS) tasks may be in paragraphs 4 and 5. Specified tasks may be listed in annexes and overlays. They may also be assigned orally during collaborative planning sessions or in directives from the higher commander.

3-66. ***Implied tasks*** are tasks that must be performed to accomplish a specified task or the mission, but are not stated in the higher headquarters order. Implied tasks are derived from a detailed analysis of the higher headquarters order, the enemy situation and COAs, and the terrain. Analysis of the unit's current location in relation to its future AO may also reveal implied tasks that must be performed to accomplish specified tasks. Additionally, analysis of doctrinal requirements for each specified task might disclose implied tasks. Only implied tasks that require allocating resources should be retained.

3-67. Once staff members have identified specified and implied tasks, they ensure they understand each task's requirements and the purpose for accomplishing each task. Then they determine the task or tasks that must be successfully executed to accomplish the mission. This task or tasks are the essential tasks. ***Essential tasks*** are specified or implied tasks that must be executed to accomplish the mission. **Essential tasks are always included in the unit's mission statement.** The staff presents the essential task or tasks to the commander for approval during the mission analysis briefing (see Task 12).

### Task 4. Review Available Assets

3-68. The commander and staff examine additions to and deletions from the current task organization, support relationships, and status (current capabilities and limitations) of all units. They consider relationships among essential, specified, and implied tasks, and between them and available assets. From this analysis, they determine if they have the assets needed to accomplish all tasks. If there are shortages, they identify additional resources needed for mission success. The staff also identifies any deviations from the normal task organization and provides them to the commander to consider when developing the planning guidance. A more detailed analysis of available assets occurs during COA development.



### Task 5. Determine Constraints

3-69. A higher commander normally places some constraints on subordinate commanders. **Constraints are restrictions placed on the command by a higher command. They dictate an action or inaction, thus restricting the freedom of action a subordinate commander has for planning.** Constraints can take the form of a requirement to do something (for example, Maintain a reserve of one company.). They can also prohibit action (for example, No reconnaissance forward of Phase Line Bravo before H-hour). The commander and staff must identify and understand these constraints. They are normally contained in the scheme of maneuver, concept of operations, or coordinating instructions. Annexes to the order may also include constraints. The operations overlay, for example, may contain a restrictive fire line or a no fire area. Constraints may also be issued orally or in WARNOs.

### Task 6. Identify Critical Facts and Assumptions

3-70. The staff gathers two categories of information concerning assigned tasks—facts and assumptions. *Facts* are statements of known data concerning the situation, including enemy and friendly dispositions, available troops, unit strengths, and materiel readiness.

3-71. An *assumption* is a supposition on the current situation or a presupposition on the future course of events, either or both assumed to be true in the absence of positive proof, necessary to enable the commander in the process of planning to complete an estimate of the situation and make a decision on the course of action. To determine assumptions, planners—

- List all assumptions received from higher headquarters.
- State expected conditions over which the commander has no control but which are relevant to the plan.
- List conditions that invalidate the plan or its concept of operations.

3-72. An assumption is appropriate if it meets the tests of validity and necessity. *Validity* means the assumption is likely to be true. “Assuming away” potential problems, such as weather or likely enemy COAs, produces an invalid assumption. *Necessity* is whether the assumption is essential for planning. If planning can continue without the assumption, it is not necessary and should be discarded.

3-73. Assumptions should be replaced with facts as soon as possible. The staff identifies the information needed to convert assumptions into facts and submits them to the appropriate agency as information requirements. If the commander needs information to make a decision, he may designate the information requirement as one of his CCIR. Requirements for information about threats and the environment are submitted to the intelligence officer. The intelligence officer incorporates them into input to the initial ISR plan.

### Task 7. Perform Risk Assessment

3-74. *Risk management* is the process of identifying, assessing, and controlling risks arising from operational factors, and making decisions that balance risk cost with mission benefits (FM 100-14). Risk management

consists of five steps that are performed throughout the operations process (see Figure 3-6).

	Step 1 – Identify Hazards	Step 2 – Assess Hazards	Step 3 – Develop Controls & Make Risk Decisions	Step 4 – Implement Controls	Step 5 – Supervise & Evaluate
Receipt of Mission	X				
Mission Analysis	X	X			
COA Development	X	X	X		
COA Analysis	X	X	X		
COA Comparison			X		
COA Approval			X		
Orders Production				X	
* Preparation				X	X
* Execution				X	X
* Not part of the MDMP.					

**Figure 3-6. Risk Management and the MDMP**

3-75. Risk is characterized by both the probability and severity of a potential loss that may result from the presence of an adversary or a hazardous condition. During mission analysis, the commander and staff assess two kinds of risk:

- *Tactical risk* is risk concerned with hazards that exist because of the presence of either the enemy or an adversary (FM 100-14).
- *Accidental risk* includes all operational risk considerations other than tactical risk. It includes risks to the friendly force. It also includes risks posed to civilians by an operation, as well as an operation’s impact on the environment (FM 100-14).

3-76. Steps 1 and 2 of the risk management process make up risk assessment. In step 1, the commander and staff identify the hazards that may be encountered during a mission. In step 2, they determine the direct impact of each hazard on the operation. The commander issues planning guidance at the end of mission analysis with risk mitigation measures for the staff to incorporate into their COA development. Risk assessment enhances situational understanding and contributes to complete planning guidance.

3-77. Commanders and staffs assess risk whenever they identify hazards, regardless of type; they do not wait until a set point in a cycle. They consider force protection issues from natural or manmade environmental hazards. They also consider the risk of potential damage to agricultural, historic, religious or cultural sites, and civil infrastructure that may result from the conduct of military operations in the area of operations. The operations officer exercises overall staff responsibility for risk assessment. Other staff sections oversee risk management for hazards within their functional areas.

**Task 8. Determine Initial Commander’s Critical Information Requirements And Essential Elements of Friendly Information**

3-78. The CCIR identify information needed by the commander to support his commander’s visualization and to make critical decisions, especially to determine or validate courses of action. They help the commander filter information available by defining what is important to mission accomplishment. They also help focus the efforts for his subordinates and

staff, assist in the allocation of resources, and assist staff officers in making recommendations. The CCIR should be limited to 10 or less at any given time to enhance comprehension. The CCIR directly affect the success or failure of the mission and they are time-sensitive in that they drive decisions at decision point. The key question is, “What does the commander need to know in a specific situation to make a particular decision in a timely manner?”

3-79. The commander alone decides what information is critical, based on his experience, the mission, the higher commanders intent, and input from the staff. During mission analysis, the staff develops information requirements. IR are all of the information elements required by the commander and his staff for the successful execution of operations, that is, all elements necessary to address the factors of METT-TC (FM 6-0). Some IR are of such importance to the commander or staff that they are nominated to the commander to become CCIR.

3-80. CCIR are situation-dependent and specified by the commander for each operation. He must continuously review the CCIR during the planning process and adjust them as situations change. During the MDMP, CCIR most often arise from the IPB and war-gaming.

3-81. The initial CCIR developed during mission analysis normally focus on decisions the commander makes to focus planning and select the optimum COA. Once the commander selects a COA, the CCIR shift to information the commander needs to make decisions during execution. Commanders designate CCIR to let the staff and subordinates know what information they deem essential for making decisions. The fewer the CCIR, the better the staff can focus its efforts and allocate scarce resources for collecting it.

3-82. In addition to nominating CCIR to the commander, the staff also identifies and nominates essential elements of friendly information (EEFI). Although EEFI are not part of the CCIR, they are a commander’s priority. EEFI help commander understand what enemy commanders want to know about friendly forces and why. They tell friendly commanders what information that cannot be compromised and provide the basis for the unit’s OPSEC plan (see FM 3-13).

### **Task 9. Determine the Initial Intelligence, Surveillance, and Reconnaissance Plan**

3-83. The initial ISR plan is crucial to begin or adjust the collection effort to help answer information requirements necessary in developing effective plans. ISR assets are tasked or dispatched as soon as possible. The initial ISR plan sets surveillance and reconnaissance in motion. It may be issued as part of a WARNO, a FRAGO, and an OPORD (see Appendix G for WARNO, OPORD, and ISR annex formats). As more information becomes available, it is incorporated into a complete ISR annex to the force OPORD. As ISR units and assets fill in gaps or the CCIR change, ISR taskings are updated. The operations officer does this with FRAGOs.

3-84. To facilitate effective planning, the unit develops and issues the initial ISR plan as soon as possible. Based on the initial IPB and CCIRs, the staff—primarily the G-2/S-2—identifies gaps in the intelligence effort and determines what assets are available to collect on these gaps. The G-3/S-3

turns this into an initial ISR Plan that tasks ISR assets as soon as possible to begin the collection effort.

3-85. The ISR plan is not an MI-specific product—the G-3/S-3 is the staff proponent of the ISR plan— it is an integrated staff product executed by the unit at the direction of the commander. The G-3/S-3, assisted by the G-2/S-2, uses the ISR plan to task and direct the available ISR assets to answer the CCIR (PIR and FFIR) and other intelligence requirements.

3-86. The initial ISR plan should contain, as a minimum—

- The AOs for surveillance and reconnaissance assets.
- ISR tasks.
- Provisions for communications, logistics, and fire support.
- Task organization.
- The reconnaissance objective (see FM 3-90).
- CCIR and IR.
- Line of departure (LD) or line of contact (LC) time.
- Initial named areas of interest (NAIs).
- Routes to the AO, and passage of lines instructions.
- Fire support coordinating measures and airspace control measures.
- Provisions for medical evacuation.

#### Task 10. Update the Operational Time Line

3-87. As more information becomes available, the commander and staff refine their initial plan for the use of available time. They compare the time needed to accomplish essential tasks to the higher headquarters operational time line to ensure mission accomplishment is possible in the allotted time. They also compare the operational time line to the enemy time line developed during IPB. From this, they determine windows of opportunity for exploitation or times when the unit will be at risk for enemy activity.

3-88. The commander and chief of staff/executive officer also refine the staff planning time line. The refined time line includes the—

- Subject, time, and location of briefings the commander requires.
- Times of collaborative planning sessions and the medium over which they will take place.
- Times, locations, and forms of rehearsals.

Commanders maximize planning time available to subordinate units by sending WARNOs as detailed planning develops. Commanders also use liaison officers to monitor changes at higher and adjacent headquarters.

#### Task 11. Write the Restated Mission

3-89. The chief of staff/executive officer or operations officer prepares a recommended mission statement for the unit based on the mission analysis. The unit's mission statement is presented to the commander for approval normally during the mission analysis brief. **A mission statement is a short sentence or paragraph describing the unit's essential task (or tasks) and purpose that clearly indicate the action to be taken and the reason for doing so. It contains the elements of who, what, when,**

**where, and why, and the reasons thereof, but seldom specifies how.** The five elements of a mission statement answer the questions—

- Who will execute the operation (unit/organization)?
- What is the unit's essential task (tactical mission task)?
- When will the operation begin (by time or event) or what is the duration of the operation?
- Where will the operation occur (AO, objective, grid coordinates)?
- Why will the force conduct the operations (for what purpose or reason)?

3-90. The unit mission statement along with the commander's intent, provide the primary focus for subordinate actions during planning, preparations, execution, and assessing. The following are two examples of a mission statement.

- NLT 220400Z AUG 05 (**When**), 1st AD (UK) (**Who**) fixes elements of the 22d Division Tactical Group (**What/Task**) in AO BLACK (**Where**) to enable 3d ID's (US) unimpeded attack West to seize OBJ STEVE (**Why/Purpose**).
- 3/75th RGR (**Who**) seizes (**What/Task**) JACKSON INT AIRPORT (**Where**) NLT D-Day, H+3 (**When**) to allow follow-on forces to air-land into AO SMALLER (**Why/Purpose**).

3-91. The mission statement may have more than one essential task. For example, if the operation is phase, there may be a different essential task for each phase.

- 3/75th RGR (**Who**) seizes (**What/Task**) JACKSON INT AIRPORT (**Where**) NLT D-day, H+3 (**When**) to allow follow-on forces to air-land into AO SLAMMER (**Why/Purpose**). On order (**When**), secure (**What/Task**) OBJ GOLD (**Where**) to prevent the 2d Pandor Guards BDE from crossing the BLUE RIVER and disrupting operations in AIRHEAD SLAMMER (**Why/Purpose**).

3-92. Additionally, the commander may choose to include the type or form of operation in the mission statement. While the mission statement seldom contains how, including the type or form of operations provides an overarching doctrinal description of how the task will be accomplished. In the example below, the commander includes "infiltrates" for emphasis and to synchronize the force. This directive limits subordinates to a specific method of attack (infiltration) that the force as a whole will use to seize OBJ BRAVO.

- At 021100Z AUG 04 (**When**) 1st Bde, 25 ID (Light) (US) (**Who**) infiltrates (**Form of Maneuver**) to seize (**What/Task**) OBJ BRAVO (**Where**) to prevent enemy forces from interfering with the rapid crossing of 3d ID (US) over the BLUE RIVER.

3-93. The *who*, *where*, *when* of the mission statement is straightforward. The *what* and *why* however, are more challenging to write clearly and can be confusing to subordinates. The *what* is a task and is expressed in terms of action verbs (for example, contain, destroy, isolate). These tasks are measurable and can be grouped by actions by friendly forces and effects on enemy forces. They *why* puts the task into context by describing the reason for conducting the task.

3-94. The *what* in the mission statement is the tactical mission task to be accomplished. FM 3-90, *Tactics*, defines tactical mission tasks as, “The specific activity performed by a unit while executing a form of tactical operation or form of maneuver. It may be expressed in terms of either actions by a friendly force or effects on an enemy force.” These tasks normally have a specific military definition that is different from those found in a dictionary. A tactical mission task is also measurable. FM 3-90 provides a list of tactical mission tasks, however, this list is not a complete list of all tasks available to the commander to choose from (see Figure 3-7).

3-95. Commanders should use doctrinal approved tasks found in combined arms field manuals or mission training plans in the mission statement. These doctrinally approved tasks have specific meaning, are measurable, and often describe results or effects of the tasks in relationship to the enemy, terrain, and friendly forces.

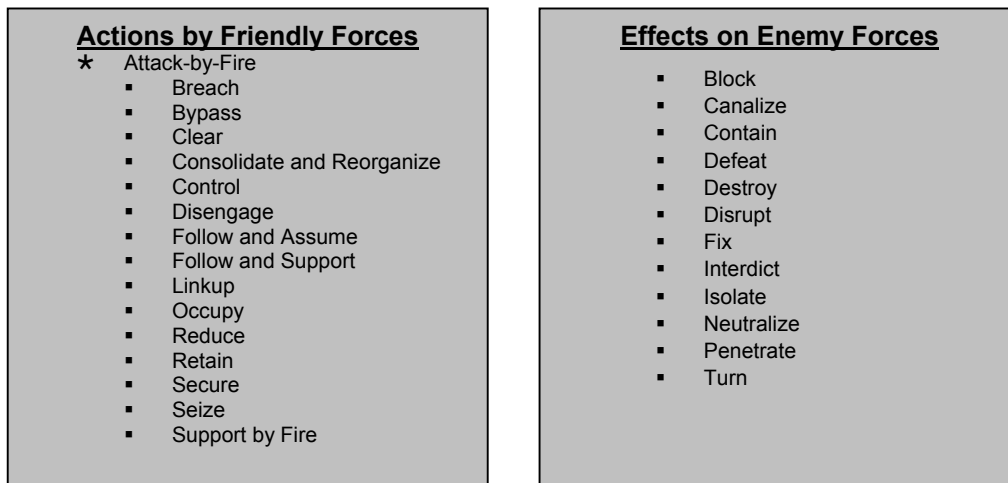

**Figure 3-7. Mission Tasks**

3-96. The *why* of a mission statement provides the mission’s purpose—why are we doing this task? The purpose is normally describe using a descriptive phrase and is often more important then the task. The below example includes a purpose in the mission statement.

- NLT 031100Z JUL 03 (**When**) 1st Bde (**Who**) secures (**What/task**) OBJ BRAVO (**Where**) to prevent enemy forces from crossing the BLUE RIVER (**Why/Purpose**).

3-97. The purpose in the mission statement provides clarity to the tasks and assists with subordinate initiatives. If the enemy chooses to cross the BLUE RIVER at a fording site 2 km West of OBJ BRAVO, subordinates would most likely notify higher headquarters and quickly repost to prevent the enemy from establishing a fording site 2 kms away. Here is an example of a mission statement without a purpose.

- At H-Hour, D-Day, 3/75 RGR seizes JACKSON INT AIRPORT (vic GL900231).

3-98. The purpose for seizing the airport in this example is unclear. Is the purpose of this mission to prevent the use of the airfield by the enemy or to gain control of the airfield for use by friendly forces? Depending on the purpose, subordinates may take several different approaches to accomplishing this mission.

### **Task 12. Deliver a Mission Analysis Briefing**

3-99. Time permitting, the staff briefs the commander on its mission analysis using the following outline:

- Mission and commander's intent of the headquarters two levels up.
- Mission, commander's intent, concept of operations, and military deception plan or deception objectives of the headquarters one level up.
- Review of the commander's initial guidance.
- Initial IPB products, including MCOO and SITTEMPs.
- Pertinent facts and assumptions.
- Specified, implied, and essential tasks.
- Constraints.
- Forces available.
- Initial risk assessment.
- Recommended initial CCIR and EEFI.
- Recommended time lines.
- Recommended collaborative planning sessions.
- Recommended restated mission.

3-100. The mission analysis briefing is given to both the commander and the staff. If appropriate, subordinate commanders may attend, either in person or by video teleconference (VTC). This is often the only time the entire staff is present and the only opportunity to ensure that all staff members are starting from a common reference point.

3-101. The briefing focuses on relevant conclusions reached as a result of the mission analysis. It is neither a readiness briefing nor a briefing of compiled data. It is a decision briefing that results in an approved restated mission, commander's intent, and commander's planning guidance (see mission analysis: Task 13. Approve the Restated Mission; Task 14. Develop the Initial Commander's Intent; and Task 15. Issue the Commander's Planning Guidance). Staff members present only relevant information the commander needs to develop situational understanding and formulate planning guidance. A comprehensive mission analysis briefing helps the commander, staff, and subordinates develop a shared understanding of the requirements of the upcoming operation.

### **Task 13. Approve the Restated Mission**

3-102. Immediately after the mission analysis briefing, the commander approves a restated mission. This can be the staff's recommended mission statement, a modified version of the staff's recommendation, or one that the commander has developed personally. Once approved, the restated mission becomes the unit mission.

#### **Task 14. Develop the Initial Commander's Intent**

3-103. The commander's intent focuses planning and gives the commander a means of indirect control of subordinate elements during execution. It must be understood and remembered by subordinates two echelons down. In the absence of orders, the commander's intent, coupled with the mission statement, directs subordinates toward mission accomplishment. When opportunities appear, subordinates use the commander's intent to decide whether and how to exploit them. Therefore, brevity and clarity in writing the commander's intent is key. The commander's intent can be in narrative or bullet form; it normally does not exceed five sentences (see Chapter 1).

#### **Task 15. Issue the Commander's Planning Guidance**

3-104. Commanders develop planning guidance from their visualization. Planning guidance may be broad or detailed, as circumstances require. However, it must convey to the staff the essence of the commander's visualization. After approving the unit mission statement and issuing their intent, commanders provide the staff (and subordinates in a collaborative environment) with enough additional guidance (including preliminary decisions) to focus staff and subordinate planning activities, and initiate preparation actions, such as movement.

3-105. The commander's planning guidance focuses on COA development, analysis, and comparison. Commanders identify the decisive operation and how they see shaping and sustaining operations supporting it, although these are not fully developed. Commanders explain how they visualize the array of forces for the decisive operation, what effects they see the decisive operation producing, and how these effects will lead to mission accomplishment. The elements of operational design—such as the desired tempo or whether the operation will consist of simultaneous or sequential actions—help convey the commander's visualization.

3-106. Specific planning guidance is essential for timely COA development and analysis. Commanders focus the staff's time and concentration by stating the planning options they do or do not want considered. The commander's planning guidance focuses on the essential tasks. It emphasizes in broad terms when, where, and how the commander intends to employ combat power to accomplish the mission within the higher commander's intent.

3-107. Commander's planning guidance includes priorities for all battlefield operating systems (BOS) (see Appendix D). It states how commanders visualize their actions within the battlefield organization. The amount of detail in the planning guidance depends on the time available, the staff's level of proficiency, and the flexibility the higher commander allows. Broad and general guidance provides maximum latitude; it allows a proficient staff to develop flexible and effective options. Under time-constrained conditions, the planning guidance is more specific and directive. The more detailed the planning guidance, the more quickly the staff can complete a plan. However, the focus that results increases the risk of overlooking or insufficiently examining things that might affect execution.



3-108. The commander's planning guidance may be written or oral. It is distributed throughout the command to ensure a common understanding. As a minimum, the commander's guidance addresses—

- The decisive operation.
- Identification of a decisive point or points.
- Potential key decisions.
- Specific COAs to consider or not, both friendly and enemy, and the priority for addressing them.
- Initial CCIR.
- Surveillance and reconnaissance guidance.
- Risk.
- Military deception.
- Fires.
- Mobility and counter-mobility.
- Security operations.
- Priorities for the BOS.
- The operational time-line.
- The type of order to issue.
- Collaborative planning sessions to be conducted.
- Movements to initiate (including command and control nodes).
- The type of rehearsal to conduct.
- Any other information the commander wants the staff to consider.

#### **Task 16. Issue a Warning Order**

3-109. Immediately after the commander gives the planning guidance, the staff sends subordinate and supporting units a WARNO that contains, as a minimum—

- The approved unit mission statement.
- The commander's intent.
- Task organization changes.
- Attachments/detachments.
- The unit AO (sketch, overlay, or some other description).
- The CCIR and EEFL.
- Risk guidance.
- Surveillance and reconnaissance instructions.
- Initial movement instructions.
- Security measures.
- Military deception guidance.
- Mobility and countermobility guidance.
- Specific priorities.
- The updated operational time line.
- Guidance on collaborative events and rehearsals.

**Task 17. Review Facts and Assumptions**

3-110. During the rest of the MDMP, the commander and staff periodically review all facts and assumptions. New facts may alter requirements and require a reanalysis of the mission. Assumptions may have become facts or may have even become invalid. Whenever the facts or assumptions change, the commander and staff assess the impact of these changes on the plan and make the necessary adjustments, including changing the CCIR, if necessary.

**COURSE OF ACTION DEVELOPMENT**

3-111. After receiving the restated mission, commander’s intent, and commander’s planning guidance, the staff develops COAs for the commander’s approval. The commander’s direct involvement in COA development can greatly aid in producing comprehensive and flexible COAs within the available time. The six steps of COA development are shown in the process column of Figure 3-8.

3-112. Staffs developing COAs ensure each one meets these screening criteria:

- **Feasible.** The unit must be able to accomplish the mission within the available time, space, and resources.
- **Acceptable.** The tactical or operational advantage gained by executing the COA must justify the cost in resources, especially casualties. This assessment is largely subjective.
- **Suitable.** A COA must accomplish the mission and comply with the commander’s planning guidance. However, commanders may modify their planning guidance at any time. When this happens, the staff records and coordinates the new guidance, and reevaluates each COA to ensure it complies with the change.
- **Distinguishable.** Each COA must differ significantly from the others. This criterion is also largely subjective. Significant differences include differences in the—
  - Use of reserves.
  - Task organization.
  - Timing (day or night).

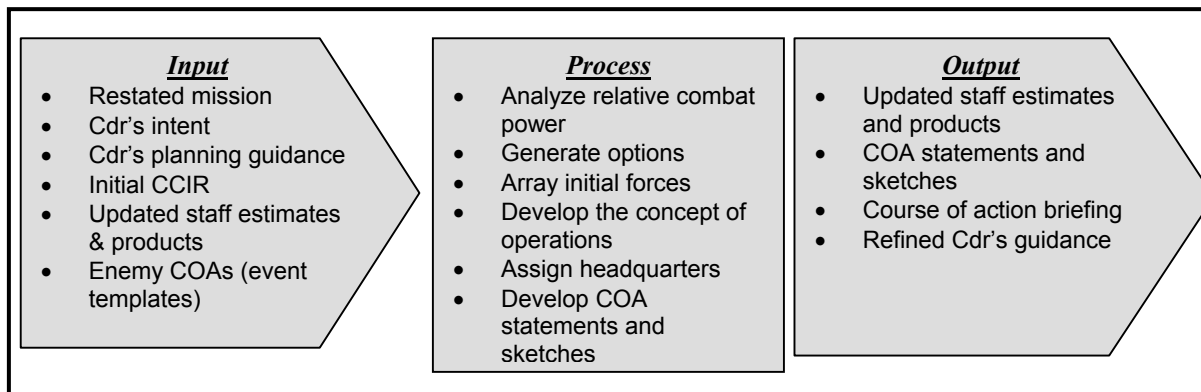

**Figure 3-8. COA Development**

- Scheme of maneuver.
- **Complete.** A COA must show how—
  - The decisive operation accomplishes the mission.
  - Shaping operations create and preserve conditions for success of the decisive operation.
  - Sustaining operations enable shaping and decisive operations.

3-113. A good COA positions the force for future operations and provides flexibility to meet unforeseen events during execution. It also gives subordinates the maximum latitude for initiative. During COA development, the commander and staff continue risk assessment, focusing on identifying and assessing hazards to mission accomplishment; they incorporate controls to reduce them into COAs. The staff also continues to revise IPB products, emphasizing event templates.

### Step 1. Analyze Relative Combat Power

3-114. *Combat power* is the total means of destructive and/or disruptive force that a military unit/formation can apply against the opponent at a given time (JP 1-02). It is a command's ability to fight or in stability operations or support operations, the ability to accomplish the mission. Commanders combine the elements of combat power—maneuver, firepower, leadership, protection, and information—to meet constantly changing requirements and defeat the enemy. Commanders integrate and apply the effects of these elements, along with CSS, against the enemy. Their goal is to generate overwhelming combat power at the decisive point to accomplish the mission at least cost.

3-115. Analyzing combat power is difficult; it requires applying both military art and science. Relative combat power analysis involves assessing tangible factors (such as, equipment, weapon systems, and units) and intangible factors (such as, morale and training levels). It also considers the factors of METT-TC that directly or indirectly affect the potential outcome of an operation. Although some numerical relationships are used, analyzing relative combat power is not the mathematical correlation of forces computations called for by former Soviet doctrine; rather, it is an estimate that incorporates both objective and subjective factors. Comparing the most significant strengths and weakness of each force in terms of combat power gives planners insight into—

- Friendly capabilities that pertain to the operation.
- The types of operations possible from both friendly and enemy perspectives.
- How and where the enemy may be vulnerable.
- How and where friendly forces are vulnerable.
- Additional resources that may be required to execute the mission.
- How to allocate existing resources.

3-116. Analyzing relative combat power includes determining force ratios and comparing friendly and enemy strengths and weakness. The purpose of this analysis is to gain insight into the type of operations possible for both friendly and enemy forces. During this step, the staff looks at these factors as

they affect the friendly and enemy force as a whole. In step 3 (array initial forces), they perform a similar analysis for each major task or event in a given COA.

3-117. Planners begin analyzing relative combat power by making a rough estimate of force ratios. At corps and division levels, planners compute force ratios between combat units two levels down. For example, division planners compare all types of combat battalions; corps planners compare friendly brigades with enemy regiments or brigade equivalents. At brigade and battalion levels, planners may study, in detail, the personnel and weapons on each side. Depending on staff resources, available time, and known data on the enemy, planners can perform a detailed computation of force ratios.

3-118. Planners do not develop and recommend COAs based solely on mathematical force ratios. While numerical relationships are useful, force ratios do not include the environmental and human factors of warfare. Many times, human factors are more important than the number of tanks or tubes of artillery. Therefore, determining relative combat power includes evaluating intangible factors, such as friction or enemy will and intentions.

3-119. After computing force ratios, the staff analyzes the intangible aspects of combat power. A technique for this analysis is comparing friendly strengths against enemy weaknesses, and vice versa, for each element of combat power (see Figure 3-9). By comparing friendly strengths against enemy weaknesses, planners deduce vulnerabilities of each force that may be exploitable or may need to be protected. These deductions may lead planners to insights on potential decision points and effective force employment.

Elements of Combat Power	Enemy strengths/ weaknesses	Friendly strengths/ weaknesses	Advantage	
			Friendly	Enemy
Maneuver	Strength: Infantry with numerous anti-tank weapons. Weakness: Poorly maintained equipment. Lack of mobility between battle positions.	Strength: 3 X M1A2 equip combined arms task forces.	X	
Firepower	Weakness: Limited to mortar fires.	Strength: Air supremacy, unopposed CAS, rocket and cannon fires.	X	
Protection	Strength: Fully constructed defensive position with overhead cover.	Strength: Night vision capability; weapons standoff. Weakness: Soft skin vehicles and dismounted infantry.		X
Leadership	Strength: Elite unit very disciplined. Weakness: Lack of initiative by subordinates without orders from higher command.	Strength: Combat tested unit. Aggressive and offensive oriented command climate.	X	
Information	Strength: Full backing of local population and regional press. Weakness: C2 very acceptable to jamming and interception.	Strength: Secure and reliable C2 systems. Weakness: Seen as invaders and occupiers by opposing force and local population.		X

**Figure 3-9. Sample Elements of Combat Power Analysis**

3-120. Planners combine the numerical force ratio with the results of their analysis of intangibles to determine the relative combat power of friendly and enemy forces. They determine what types of operations are feasible by comparing the force ratio with the historical minimum planning ratios for the contemplated combat missions (see Figure 3-10) and estimating the extent to which intangible factors affect the relative combat power. If, in the staff's judgment, the relative combat power of the force produces the effects of the historical minimum-planning ratio for a contemplated mission, that mission is feasible.

<i>Friendly mission</i>	<i>Position</i>	<i>Friendly: Enemy</i>
Delay		1: 6
Defend	Prepared or fortified	1: 3
Defend	Hasty	1: 2.5
Attack	Prepared or fortified	3: 1
Attack	Hasty	2.5: 1
Counterattack	Flank	1: 1

**Figure 3-10. Historical Minimum Planning Ratios**

3-121. In missions characterized by stability operations or support operations, staffs often determine relative combat power by comparing available resources to the tasks assigned—troop to task analysis. This provides insight as to what options are available and if more resources are required. In such operations, the elements of maneuver, non-lethal fires, leadership, and information may predominate.

## Step 2. Generate Options

3-122. Based on the commander's guidance and the results of step 1, the staff generates options for COAs. A good COA can defeat all feasible enemy COAs. In a totally unconstrained environment, the goal is to develop several possible COAs. Since there is rarely enough time to do this, commanders usually limit the options in the commander's guidance. Options focus on enemy COAs arranged in order of their probable adoption.

3-123. Brainstorming is the preferred technique for generating options. It requires time, imagination, and creativity, but it produces the widest range of choices. The staff remains unbiased and open-minded in evaluating proposed options. Staff members quickly identify COAs that are not feasible due to factors in their functional areas. They also quickly decide if a COA can be modified to accomplish the requirement or should be eliminated immediately. Staff members who identify information that might affect other functional areas share it immediately. This eliminates wasted time and effort.

3-124. In developing COAs, staff members determine the doctrinal requirements for each type of operation being considered, including doctrinal tasks for subordinate units. For example, a deliberate breach requires a breach force, a support force, and an assault force. In addition, the staff considers possibilities created by attachments. For example, a light infantry brigade attached to an armored division might allow an air assault.

3-125. To develop options, the staff starts with the decisive operation identified in the commander's planning guidance. The decisive operation must be nested within the higher headquarters concept of operations. The staff determines the decisive operation's purpose (if not stated by the commander) and considers ways to mass the effects of overwhelming combat power to achieve it. The decisive operation's purpose directly relates to accomplishing the unit mission. When executed, the decisive operation becomes the main effort.

### Sample Shaping Operations

- Economy of force actions
- Security operations
- Actions designed to limit enemy freedom of action, such as:
  - Denying the enemy the ability to concentrate
  - Fixing enemy forces
- Destruction of enemy capabilities
- Information operations (including military deception)
- Civil-military operations

3-126. Next, the staff considers shaping operations. The staff establishes a purpose for each shaping operation that is tied to creating or preserving a condition for the decisive operation's success. Shaping operations may occur before, concurrently with,

or after the decisive operation. A shaping operation may be designated the main effort if executed before or after the decisive operation.

3-127. The staff then determines sustaining operations necessary to create and maintain the combat power required for the decisive operation and shaping operations. After developing the basic battlefield organization for a given COA, the staff then determines the essential tasks for each decisive, shaping, and sustaining operation.

3-128. Once staff members have explored each COAs possibilities, they examine each COA to determine if it satisfies the screening criteria stated in paragraph 3-112. They change, add, or eliminate COAs as appropriate. Staffs avoid the common pitfall of presenting one good COA among several “throw-away” COAs. Often commanders combine COAs or move desirable elements from one to another.

### Step 3. Array Initial Forces

3-129. To determine the forces necessary to accomplish the mission and to provide a basis for the scheme of maneuver, planners consider—

- The higher commander’s intent and concept of operations.
- The unit mission statement and the commander’s intent and planning guidance.
- The air and ground avenues of approach.
- As many possible enemy COAs as time permits, starting with the most likely and including the most dangerous.

3-130. Planners then determine the relative combat power required to accomplish each task, starting with the decisive operation and continuing through all shaping operations. They follow a procedure similar to that in step 1. Using the minimum historical planning ratios shown in Figure 3-10 as a starting point, planners determine the combination of tangible and intangible assets required to accomplish each task.

3-131. For example, historically defenders have over a 50-percent probability of defeating an attacking force approximately three times their equivalent strength. Therefore, as a starting point, commanders may defend on each avenue of approach with roughly a 1:3 force ratio. However, defenders have many advantages: for example, full use of cover and concealment, selection of the ground on which to fight, weapons sighted for maximum effectiveness, choice of firing first, and use of obstacles. Planners determine whether these and other intangibles increase the relative combat power of the unit assigned the task to the point that it exceeds the historical planning ratio for that task. If it does not, planners determine how to reinforce the unit. Relative combat power is only a planning tool for developing COAs. It cannot predict the results of actual combat.

3-132. Planners next determine a proposed forward edge of the battle area (FEBA) (in the defense) or a line of departure (in the offense). In the case of a noncontiguous AO, planners consider AOs for subordinate units. The intelligence officer’s initial terrain analysis should validate the selection or help determine a recommended change. Planners resolve any changes with higher headquarters as necessary.

3-133. Planners then consider military deception operations (see FM 3-13). Because aspects of the military deception operation may influence unit positioning, planners consider the military deception operation's major elements before developing any COA.

3-134. Planners next make the initial array of friendly forces, starting with the decisive operation and continuing with all shaping and sustaining operations. Planners normally array ground forces two levels down. The initial array focuses on generic ground maneuver units without regard to specific type or task organization, and then considers all appropriate intangible factors. For example, at corps level, planners array generic brigades. During this step, planners do not assign missions to arrayed units; they only consider what forces are necessary to accomplish the mission.

3-135. The initial array identifies the total number of units needed and identifies possible methods of dealing with the enemy. If the number arrayed is less than the number available, the additional units are placed in a pool for use during concept of operations development (step 4). If the number of units arrayed is greater than the number available and the difference cannot be compensated for with intangible factors, the staff determines whether the COA is feasible. Ways to make up the shortfall include requesting additional resources, accepting risk in that portion of the AO, or executing tasks required for the COA sequentially rather than simultaneously.

#### **Step 4. Develop the Concept of Operations**

3-136. The concept of operations describes how arrayed forces will accomplish the mission within the commander's intent. It concisely expresses the "how" of the commander's visualization and governs the design of supporting plans or annexes. The concept of operations summarizes the contributions of all BOS and information operations (IO). The staff develops a concept of operations for each COA.

3-137. Ideally, decisive, shaping, and sustaining operations occur at the same time. Simultaneous operations allow commanders to seize and retain the initiative. However, they require overwhelming combat power across the AO. If the initial array of forces shows a combat power shortfall, planners recommend phasing the operation. When recommending if the operations should be simultaneous or sequential, planners consider—

- The skill and size of the opponent.
- The size of the AO.
- Operational reach.
- Available joint support.
- The scope of the mission.

The crucial consideration is the success of the decisive operation, which must have enough combat power to win decisively. If that combat power is not available, planners develop the COA based on achieving the maximum possible simultaneous action within each phase.

3-138. Planners develop a concept of operations by refining the initial array of forces. To do this, they use graphical control measures to coordinate the operation and show the relationship of friendly forces to one another, the



enemy, and the terrain. During this step, unit types are converted from generic to specific, such as, armor, light infantry, and mechanized infantry. The concept of operations considers the following—

- The purpose of the operation.
- A statement of where the commander will accept tactical risk.
- Identification of critical friendly events and transitions between phases (if the operation is phased).
- Designation of the decisive operation, along with its task and purpose, linked to how it supports the higher headquarters' concept.
- Designation of shaping operations, along with their tasks and purposes, linked to how they support the decisive operation.
- Designation of sustaining operations, along with their tasks and purposes, linked to how they support the decisive operation and shaping operations.
- Designation of reserve, including its location, composition.
- ISR operations.
- Security operations.
- Identification of maneuver options that may develop during an operation.
- Location of engagement areas, or attack objectives and counterattack objectives.
- Assignment of subordinate AOs.
- Concept of fires.
- IO concept of support including military deception.
- CMO concept of support.
- Prescribed formations or dispositions, when necessary.
- Priorities for each battlefield operating system.
- Integration of obstacle effects with maneuver and fires.
- Considerations of the effects of enemy weapons of mass destruction (WMD) on the force.

3-139. Planners select control measures (graphics) to control subordinate units during the operation. Control measures help commanders direct action by establishing responsibilities and limits to prevent units from impeding one another and to impose necessary coordination. They may be permissive or restrictive. A commander should impose only the minimum control measures needed to provide essential coordination and deconfliction among units. Commanders remove restrictive control measures as soon as possible. Control measures may be graphical, written, or procedural. (See FM 3-90 for a discussion of control measures associated with each type of operations and FM 1-02 for a listing of doctrinal control measures and rules for drawing control measures on overlays and maps.)

3-140. Planners base control measures on the array of forces and on the concept of operations. Control measures should not split avenues of approach or key terrain. Planners leave space on the flanks of each avenue of approach to allow for maneuver and fires. To mass the effects of combat power, the AO designated for the decisive operation may be narrower than other AOs.

Planners may establish phase lines to trigger execution of branches and sequels.

3-141. When developing the concept of operations, planners use any forces remaining from the initial array to weight the decisive operation, strengthen the reserve, or increase ISR operations.

#### **Step 5. Assign Headquarters**

3-142. After determining the concept of operations, planners create a task organization by assigning headquarters to groupings of forces (see Appendix F). They consider the types of units to be assigned to a headquarters and its span of control. Generally, a headquarters controls at least two subordinate maneuver units, but not more than five. If planners need additional headquarters, they note the shortage and resolve it later. Task organization takes into account the entire battlefield organization. It also accounts for the special command and control requirements for operations such as a passage of lines, river crossing, or air assault.

**Step 6. Prepare COA Statements and Sketches**

3-143. The operations officer prepares a COA statement and supporting sketch for each COA. The COA statement clearly portrays how the unit will accomplish the mission and explains the concept of operations. It is written in terms of the battlefield organization and includes the mission and end state. The sketch provides a picture of the maneuver aspects of the concept of operations. Together, the statement and sketch cover the who (generic task organization), what (tasks), when, where, why (purpose), for each subordinate unit. It states any significant hazards to the force as a whole and where they occur. The commander makes risk decisions regarding them during COA approval. Figure 3-11 provides a sample COA sketch and Figure 3-12 provides a COA statement for a mechanized division conducting a linear, contiguous operation.

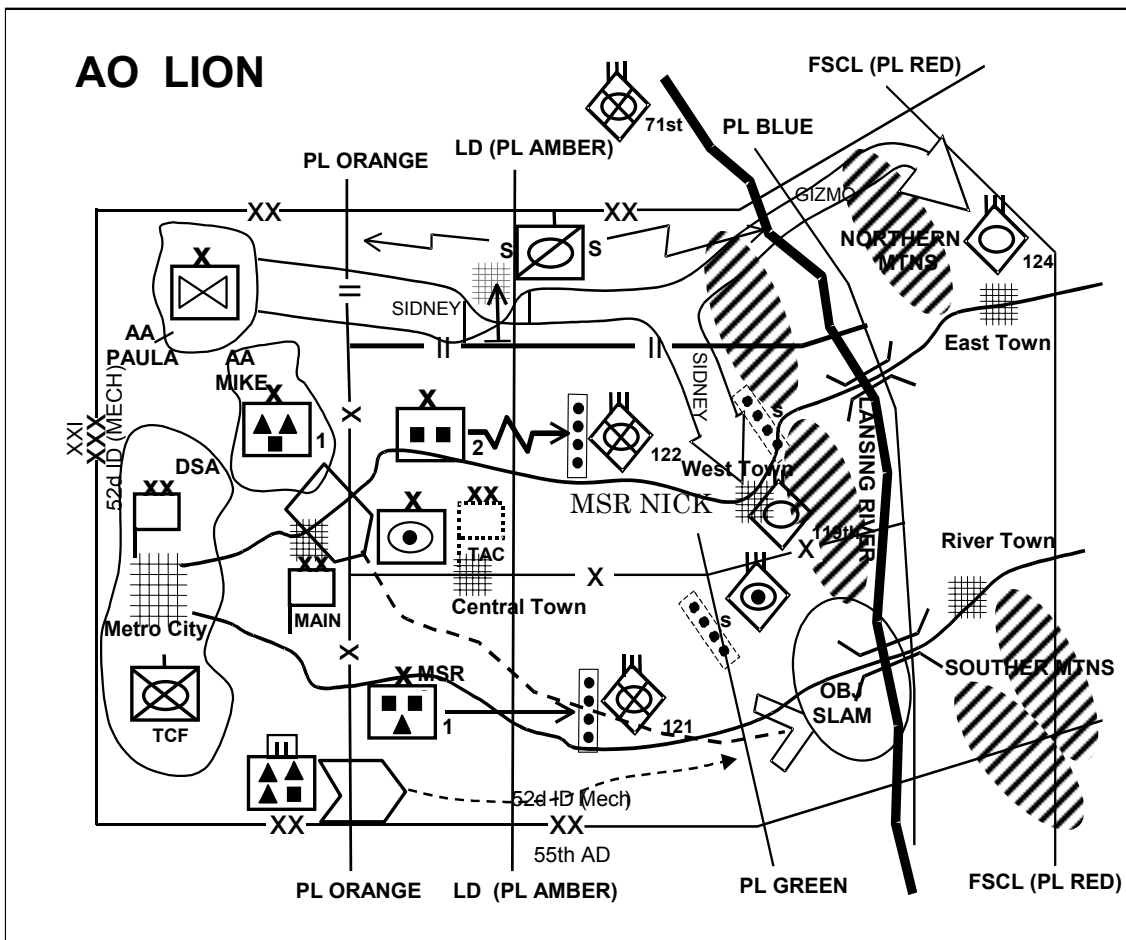

Figure 3-11. Course of Action Sketch

**MISSION:** At 170400Z March 03, 52d ID (Mech) attacks to defeat elements of the 12th DTG in AO LION to protect the northern flank of the 55th AD, the 21st (US) Corps main effort.

**INTENT:** The purpose of this attack is to prevent repositioning of 12th DTG forces to the south and interfering with 21st (US) Corps decisive operation (the 55th AD's seizure of OBJ STRIKE). Key tasks are:

- ◆ Destroy 73d Brigade Tactical Group (BTG) south of the METRO CITY-CENTRAL TOWN-RIVER TOWN Line to prevent their repositioning south into 55th AD's AO.
- ◆ Seize OBJ SLAM by 181800Z MAR 03 to secure the northern flank of the 55th AD.
- ◆ Defeat the 12th DTG's reserve (23d BTG) vicinity EAST TOWN to prevent them from interfering with the seizure of OBJ SLAM.

At end state, the corps' right flank is secure with two brigades consolidated in defense positions vicinity OBJ SLAM. The division is prepared to conduct follow-on offensive operations to defeat enemy to PL RED.

**DECISIVE OPERATION:** Armor Bde #1 passes through the southern Mech Bde # 1 east of PL AMBER and attacks to seize the key terrain vicinity of OBJ SLAM in order to protect 55th AD's northern flank.

**SHAPING OPERATIONS:** Mech Bde #1 in the south, the initial main effort, conducts a penetration to destroy enemy force vicinity PL AMBER to create enough maneuver space for Armor Bde #1 to pass to the East without interference from the 73d BTG in order to seize key terrain vicinity of OBJ SLAM and protect the northern flank of the 55th AD. Armor Bde #1 becomes the main effort after conducting forward passage of lines with Mech Bde # 1 and then accepts battle-handover along PL GREEN. Mechanized Bde #1 then follows and supports Armor Bde #1 and the division reserve by attacking east to clear remaining elements of the 73d from PL Amber to PL Green in order to protect the rear of both units.

The division reserve, an armor-heavy task force, initially follows Mechanized Bde #1 with the following priorities of commitment: 1). Contain enemy forces capable of threatening Armor Bde # 1's passage through Mechanized Bde # 1 allowing battle-handover to occur along PL Green. 2). If not committed west of PL Green, follows Armor Bde # 1 and blocks enemy force capable of threatening this brigades movement east enabling it to seize the key terrain vicinity of OBJ SLAM and protect the north flank of the 55th AD.

In the north, Mech Bde #2 attacks east to fix the 72d BTG denying it the ability to interfere with the division's decisive operations in the south. The division cavalry squadron conducts a moving flank screen along the division's northern boundary to provide early warning of enemy forces attacking south into the northern flank of Mech Bde # 2.

**Figure 3-12. Course of Action Statement (COA #1)**

**COA # 1 (continued)**

Once Mech Bde #1 crosses PL AMBER (LD), the division attack helicopter battalion (AHB) attacks along AIR AXIS SIDNEY to destroy the enemy tank battalion vicinity WEST TOWN to protect then northern flank of Mech Bde #1 and allowing it to pass Armor Bde #1 east. Once Armor Bde #1 accepts battle-handover along PL GREEN, the AHB attacks along AIR AXIS GIZMO to defeat the 23d BTG south and east of the NORTHERN MOUNTAINS to allow Armor Bde. #1 to seize the key terrain vicinity of OJB SLAM and protect the northern flank of the 55th AD.

**Division fires** will: 1). Conduct SEAD along AIR AXES SIDNEY and GIZMO to allow the AHB to destroy the enemy tank battalion vicinity WEST TOWN and to defeat the 23d BTG south and east of the NORTHERN MOUNTAINS, respectively; 2). Conduct counter fire to neutralize two battalions of the 12th DTG's Integrated Fires Command (IFC) to prevent it from massing fires against the southern two brigades; 3). Provide suppressive fires against 73d BTG defenses along PL AMBER to enable Mech #1's penetration.

**Division ISR** operations focus on: 1). Identifying the location and disposition of the 73d BTG battle zone to determine optimal point of penetration for MECH Bde # 1 along PL AMBER; 2). Location and disposition of the 12th DTGs IFC assets to assist counter fire efforts; 3). Location and intentions of the enemy tank battalion and ADA assets vicinity WEST TOWN, and location and intention of the 23d BTG, the enemy's reserve, vicinity the NORTHERN MOUNTAINS, to assist the AHB attacks.

**SUSTAINING OPERATION.** The division support area will establish vicinity METRO CITY with MSRs SEAN and NICK as the primary routes used to sustain combat power during the attack. A mechanized company team is the division TCF with priority of responding to any LEVEL III treats to division class III supply point.

**The deception objective is:** commander of the 12th DTG commits his reserve, the 23d BTG, at H+10 to block penetration of US forces in the north of AO LION in order to protect the 24th DTG, the 1st Field Group's main effort. The deception story is that the division's decisive operation is in the north, with the following indicators: the initial positioning of an armor-heavy brigade in the northern portion of the rear are in AA MIKE, simultaneous attacks of two brigades abreast in the north and south, the division cavalry squadron operating on the north flank of the division AO, and early commitment of the division's AHB destroy an enemy tank battalion in the north.

**Tactical risk** is assumed by early commitment of the division's AHB, potentially leaving it without sufficient combat power to defeat the 23d BTG, the enemy's reserve.

**Figure 3-12. COA Statement (continued)**

3-144. As a minimum, the COA sketch includes the array of generic forces and control measures, such as—

- The unit and subordinate unit boundaries.
- Unit movement formations (but not subordinate unit formations).
- The FEBA, LD, or LC, and phase lines, if used.
- Reconnaissance and security graphics.
- Ground and air axes of advance.
- Assembly areas, battle positions, strong points, engagement areas, and objectives.
- Obstacle control measures and tactical mission graphics.
- Fire support-coordinating measures.
- Designation of the decisive operation and shaping operations.
- Location of command posts and critical information systems (INFOSYS) nodes.
- Enemy known or templated locations.

3-145. Planners can include identifying features (such as, cities, rivers, and roads) to help orient users. The sketch may be on any medium. What it portrays is more important than its form.

### **Course of Action Briefing**

3-146. After developing COAs, the staff briefs them to the commander. A collaborative session may facilitate subordinate planning. The COA briefing includes—

- An updated IPB.
- Possible enemy COAs (event templates).
- The unit mission statement.
- The commander's and higher commanders' intent.
- COA statements and sketches.
- The rationale for each COA, including—
  - Considerations that might affect enemy COAs.
  - Critical events for each COA.
  - Deductions resulting from the relative combat power analysis.
  - The reason units are arrayed as shown on the sketch.
  - The reason the staff used the selected control measures.
  - Updated facts and assumptions.
- Recommended evaluation criteria.

3-147. After the briefing, the commander gives additional guidance. If all COAs are rejected, the staff begins again. If one or more of the COAs are accepted, staff members begin COA analysis. The commander may create a new COA by incorporating elements of one or more COAs developed by the staff. The staff then prepares to war-game this new COA.

### **COURSE OF ACTION ANALYSIS (WAR GAMING)**

3-148. COA analysis allows the staff to synchronize the BOS for each COA and identify the COA that best accomplishes the mission. It helps the commander and staff to—

- Determine how to maximize the effects of combat power while protecting friendly forces and minimizing collateral damage.
- Further develop a visualization of the battle.
- Anticipate battlefield events.
- Determine conditions and resources required for success.
- Determine when and where to apply force capabilities.
- Focus IPB on enemy strengths and weaknesses, and the desired end state.
- Identify coordination needed to produce synchronized results.
- Determine the most flexible COA.

3-149. COA analysis (war gaming) is a disciplined process. It includes rules and steps that help commanders and staffs visualize the flow of a battle (see Figure 3-13). The process considers friendly dispositions, strengths, and weaknesses; enemy assets and probable COAs; and characteristics of the AO. It relies heavily on an understanding of doctrine, tactical judgment, and experience. War-gaming focuses the staff's attention on each phase of the operation in a logical sequence. It is an iterative process of action, reaction, and counteraction.

3-150. War-gaming stimulates ideas, highlights critical tasks, and provides insights that might not otherwise be discovered. It is a critical step in the MDMP and should be allocated more time than any other step. The commander or chief of staff/executive officer determines how much time is available for war gaming and ensures this time line is followed.

3-151. During the war game, the staff takes each COA and begins to develop a detailed plan, while determining its strengths or weaknesses. War-gaming tests and improves COAs. The commander and staff (and subordinate commanders and staffs if the war game is conducted collaboratively) may change an existing COA or develop a new COA after identifying unforeseen events, tasks, requirements, or problems.

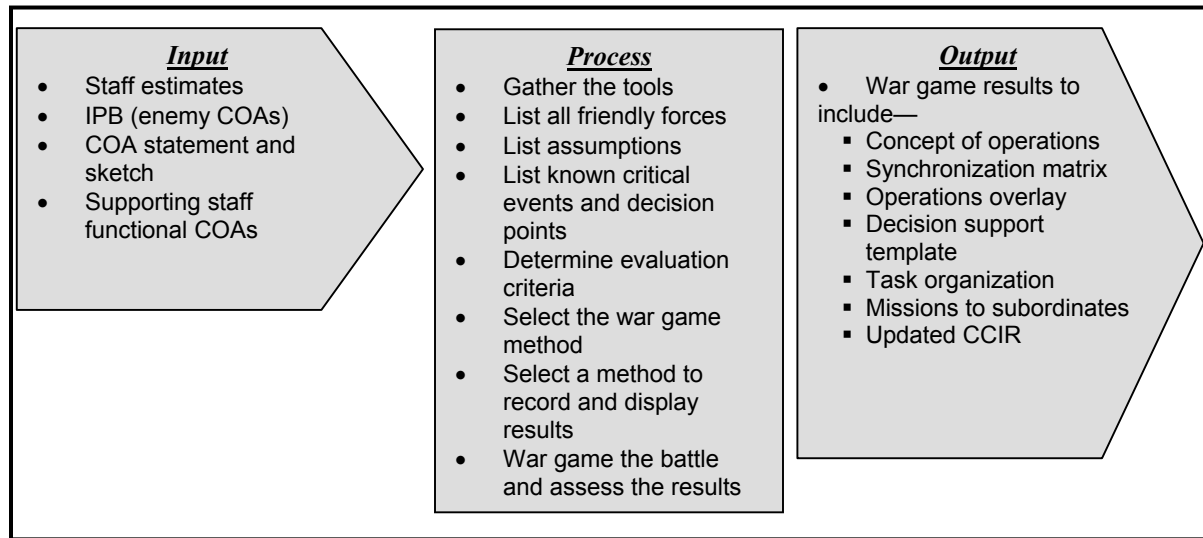

Figure 3-13. Course of Action Analysis (War Game)

### General War-gaming Rules

3-152. War gamers need to—

- Remain objective, not allowing personality or their sensing of “what the commander wants” to influence them. They avoid defending a COA just because they personally developed it.
- Accurately record advantages and disadvantages of each COA as they emerge.
- Continually assess feasibility, acceptability, and suitability of each COA. If a COA fails any of these tests, they reject it.
- Avoid drawing premature conclusions and gathering facts to support such conclusions.
- Avoid comparing one COA with another during the war game. This occurs during COA comparison.

### War-gaming Responsibilities

3-153. The chief of staff/executive officer is responsible for coordinating actions of the staff during the war game. He is the unbiased controller of the process, ensuring the staff stays on a time line and accomplishes the goals of the war-gaming session. In a time-constrained environment, he ensures that, as a minimum, the decisive operation is war gamed. Staff members have the following responsibilities during the war game.

3-154. **Personnel Officer.** The G1/AG (S-1) estimates potential personnel battle losses and determines human resources support for the operation.

3-155. **Intelligence Officer.** The G-2 (S-2) role-plays the enemy commander. He develops critical enemy decision points in relation to the friendly COAs, projects enemy reactions to friendly actions, and projects enemy losses. When additional intelligence staff members are available, the



intelligence officer assigns different responsibilities to individual staff members within the section for war-gaming (such as, the enemy commander, friendly intelligence officer, and enemy recorder). The intelligence officer captures the results of each enemy action and counteraction, and the corresponding friendly and enemy strengths and vulnerabilities. By trying to win the war game for the enemy, the intelligence officer ensures that the staff fully addresses friendly responses for each enemy COA. For the friendly force, the intelligence officer—

- Identifies IRs and recommends PIRs.
- Refines the situation and event templates, including named areas of interest (NAIs) that support decision points.
- Refines the event template and matrix with corresponding decision points, targeted areas of interest (TAIs), and HVTs.
- Participates in targeting to select high-payoff targets (HPTs) from HVTs identified during IPB.
- Recommend PIR that correspond to the decision points.

**3-156. Operations Officer.** The G-3 (S-3) normally selects the technique for the war game and role-plays the friendly commander. The operations staff ensures that the war game of each COA covers every operational aspect of the mission. They record each event's strengths and weaknesses, and the rationale for each action. When staff members are available, the operations officer assigns different responsibilities for war-gaming. The rationale for actions during the war game are annotated and used later, with the commander's guidance, to compare COAs.

**3-157. Logistics Officer.** The G-4 (S-4) assesses the sustainment feasibility of each COA. The G-4/S-4 determines critical requirements for each sustainment function and identifies potential problems and deficiencies. He assesses the status of all sustainment functions required to support the COA and compares it to available assets. He identifies potential shortfalls and recommends actions to eliminate or reduce their effects. While improvising can contribute to responsiveness, only accurate prediction of requirements for each sustainment function can ensure continuous sustainment. The logistics officer ensures that available movement times and assets support each COA.

**3-158. Civil-Military Operations Officer.** The G-5 (S-5) ensures each COA effectively integrates civil considerations (the "C" of METT-TC). The CMO officer considers not only tactical issues, but also CS and CSS issues. Host-nation support and care of displaced civilians are of particular concern. The CMO officer's analysis considers the impact of operations on public order and safety, the potential for disaster relief requirements, noncombatant evacuation operations, emergency services, and protection of culturally significant sites. The CMO officer provides feedback in how the culture in the AO affects each course of action. If the unit does not have an assigned CMO officer, the commander assigns these responsibilities to another staff member.

**3-159. Command, Control, Communications, and Computer (C4) Operations Officer.** The G-6 (S-6) assesses the communications feasibility of each COA. He determines C4 requirements and compares them to

available assets. He identifies potential shortfalls and recommends actions to eliminate or reduce their effect.

3-160. **Information Operations Officer.** The G-7 (S-7) synchronizes IO and assists the staff in integrating IO into each COA. The IO officer addresses how each IO element supports each COA and its associated time lines, critical events, and decision points. The IO officer revises IO concepts of support as needed during war-gaming.

3-161. **Special Staff Officers.** Special staff officers support the coordinating staff by analyzing the COAs from the perspective of their functional areas, indicating how they can best support them. Every staff member determines the requirements for external support, the risks, and each COA's strengths and weaknesses. Collaborative war-gaming can greatly facilitate and refine these actions. In addition, when conducted collaboratively, war-gaming allows subordinates to see refinements to the concept of operations that emerge immediately. Subordinates can then alter their own COAs without waiting for a WARNO outlining the change.

3-162. **Recorders.** The use of recorders is particularly important. Recorders are trained to capture coordinating instructions, subunit tasks and purposes, and information required to synchronize the operation. Doing this allows part of the order to be written before planning is complete. Automated INFOSYS simplify this process: they allow entering information into preformatted forms that represent either briefing charts or appendices to orders. Each staff section should have formats available to facilitate networked orders production.

3-163. **Location.** The location used for the war game must be prepared and configured by the time the staff is ready to execute the war game. Charts, boards, computer displays, etc, must be serviceable and prepared for use. The blown-up terrain sketch and enemy situation templates must be prepared and present. Automated briefing products must be updated and digital terrain maps for the AO loaded in the appropriate INFOSYS. Automated tools for war-gaming must have correct data entered.

### War-gaming Steps

3-164. The staff follows eight steps during war gaming:

- Gather the tools.
- List friendly forces.
- List assumptions.
- List known critical events and decision points.
- Determine evaluation criteria.
- Select the war-game method.
- Select a method to record and display results.
- War-game the battle and assess the results.

3-165. **Step 1. Gather the Tools.** The chief of staff/executive officer directs the staff to gather the necessary tools, materials, and data for the war game. Units war-game with maps, sand tables, computer simulations, or other tools

that accurately reflect the nature of the terrain. The staff posts the COA on a map displaying the AO. Tools required include, but are not limited to—

- Current staff estimates.
- Event templates.
- A recording method.
- Completed COAs, including maneuver, reconnaissance and surveillance, and security graphics.
- Means to post or display enemy and friendly unit symbols.
- A map of the AO.

3-166. **Step 2. List All Friendly Forces.** The commander and staff consider all units that can be committed to the operation, paying special attention to support relationships and constraints. The friendly force list remains constant for all COAs.

3-167. **Step 3. List Assumptions.** The commander and staff review previous assumptions for continued validity and necessity.

3-168. **Step 4. List Known Critical Events and Decision Points.** Critical events are those that directly influence mission accomplishment. They include events that trigger significant actions or decisions (such as commitment of an enemy reserve), complicated actions requiring detailed study (such as a passage of lines), and the essential tasks. The list of critical events includes major events from the unit's current position through mission accomplishment.

3-169. **A decision point is an event, area, or point in the battlespace where and when the friendly commander will make a critical decision.** Decision points may also be associated with the friendly force and the status of ongoing operations (Army-Marine Corps). A decision point will be associated with CCIR that describes what information the commander must have to make the anticipated decision. The PIR will describe what must be known about the enemy, and will often be associated with a named area of interest (NAI). A decision point requires a decision by the commander. It does not dictate what the decision is, only that the commander must make one, and when and where it should be made to have maximum impact on friendly or enemy COAs.

3-170. **Step 5. Determine Evaluation Criteria.** Evaluation criteria are factors the staff uses to measure the relative effectiveness and efficiency of one COA relative to other COAs after the war game. They address factors that affect success and those that can cause failure. Evaluation criteria change from mission to mission. They must be clearly defined and understood by all staff members before starting the war game. Examples of evaluation criteria for offensive and defensive operations include—

- Mission accomplishment at an acceptable cost.
- The principles of war.
- Doctrinal fundamentals for the type and form of operation being conducted (see FM 3-90).
- The commander's guidance and intent.
- The level of tactical risk.

- Measures of performance listed in FM 7-15.

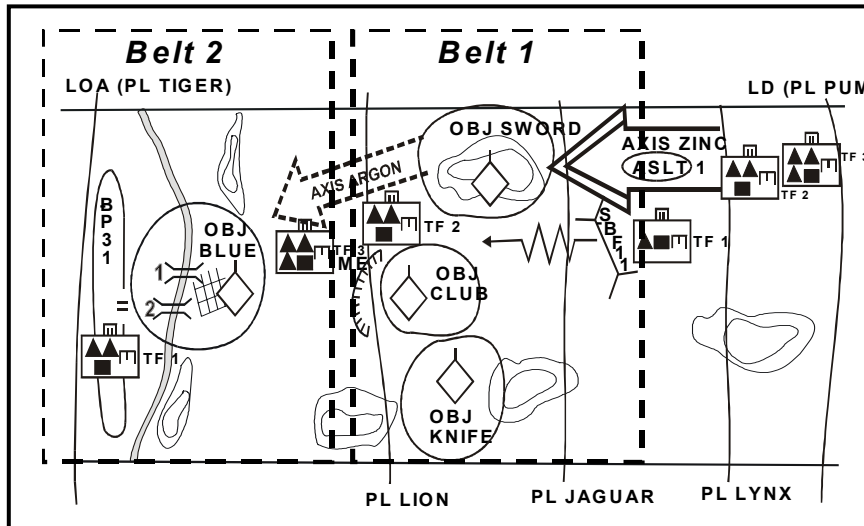

Figure 3-14. Belt Method

3-171. **Step 6. Select the War Game Method.** There are three recommended war game methods: belt, avenue-in-depth, and box. Each considers the area of interest and all enemy forces that can affect the outcome of the operation. The methods can be used separately or in combination. The staff may devise a method of its own.

3-172. The *belt method* divides the AO into belts (areas) running the width of the AO (see Figure 3-14). The shape of each belt is based on the factors of METT-TC. The belt method is most effective when terrain is divided into well-defined cross-compartments, during phased operations (such as, river crossings, air assaults, or airborne operations), or when the enemy is deployed in clearly defined belts or echelons. Belts can be adjacent to or overlap each other. As a minimum, belts should include the area of—

- Initial contact either along the forward line of own troops, LD, or LC, or in the covering force area.
- Initial penetration or initial contact along the FEBA.
- Passage of the reserve or commitment of a counterattack.
- The objective (offense) or defeat of the enemy (defense).

3-173. This method is based on a sequential analysis of events in each belt. It is preferred because it focuses simultaneously on all forces affecting a particular event. A belt might include more than one critical event. Under time-constrained conditions, the commander can use a modified belt method. The modified belt method divides the AO into not more than three sequential belts. These belts are not necessarily adjacent or overlapping, but focus on the critical actions throughout the depth of the AO.

3-174. The avenue-in-depth method focuses on one avenue of approach at a time, beginning with the decisive operation (see Figure 3-15). This method is

good for offensive COAs or in the defense when canalizing terrain inhibits mutual support.

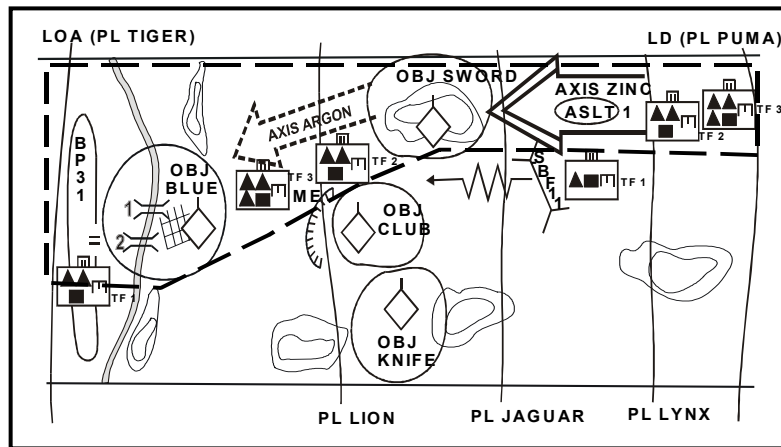

Figure 3-15. Avenue-in-Depth Method

3-175. The *box method* is a detailed analysis of a critical area, such as an engagement area, a river-crossing site, or a landing zone. It is appropriate when time is constrained, as in a hasty attack. It is particularly useful when planning operations in noncontiguous AOs. When using this method, the staff isolates the area and focuses on critical events in it. Staff members assume that friendly units can handle most of the situations on the battlefield and focus their attention on essential tasks.

3-176. **Step 7. Select a Method to Record and Display Results.** The war game's results provide a record from which to build task organizations, synchronize activities, develop decision support templates, confirm and refine event templates, prepare plans or orders, and compare COAs. Two methods are used to record and display results: the synchronization matrix (see Figure 3-16) and the sketch note technique (see Figure 3-17). In both, staff members record any remarks regarding the strengths and weaknesses they discover. The amount of detail depends on the time available. Unit standard operating procedures (SOPs) address details and methods of recording and displaying war game results.

3-177. The synchronization matrix method allows the staff to synchronize the COA across time and space in relation to an enemy COA. The first entry is time or phases of the operation. The second entry is the most likely enemy action. The third entry is the decision points for the friendly COA. The remainder of the matrix is developed around selected functional areas and the unit's major subordinate commands. Other operations, functions, and units that are to be integrated, or the use of which the staff wants to highlight, can be incorporated into the matrix.

3-178. The sketch note method uses brief notes concerning critical locations or tasks and purposes. These notes refer to specific locations or relate to general considerations covering broad areas. The commander and staff note locations on the map and on a separate war-game work sheet (see Figure 3-

17). Staff members use sequence numbers to link the notes to the corresponding locations on the map or overlay. Staff members also identify actions by placing them in sequential action groups, giving each subtask a separate number. They use the war game work sheet to identify all pertinent data for a critical event. They assign each event a number and title, and use the columns on the work sheet to identify and list in sequence—

- Units and assigned tasks.
- Expected enemy actions and reactions.
- Friendly counteractions and assets.
- Total assets needed for the task.
- Estimated time to accomplish the task.
- The decision point tied to executing the task.
- CCIR.
- Control measures.

Time/Event		H – 8	H-hour	H + 8
Enemy Action		Enemy Monitors Movements	Defends from Security Zone	Commits Reserve
Decision Points		Launch Deep Attack		
Maneuver	1st Bde	Move on Route Paula	Cross LD	Seize OBJ NICK
	2d Bde	Move on Route Mike	Cross LD	Seize OBJ DAVE
	3d Bde	Move on Route Sean		FPOL with 1st BDE
	Avn Bde	Deep Attack on Objective		
	Div Cav	Rose @ H-1	Screen North Flank	
Air Defense		Weapons Hold		
Fire Support		Prep Fires Initiated at H-5		
Information Operations		Surrender Broadcasts		Enemy C2 Jammed
M/CM/S		Route Maintained		
CSS		MSR Tampa Closed South Bound		
C2			TAC CP with Lead Brigade	
NOTE: The first column is representative only and can be modified to fit unit needs.				

**Figure 3-16. Sample Synchronization Matrix Format**

3-179. **Step 8. War Game the Battle and Assess the Results.** During the war game, the commander and staff try to foresee the battle’s action, reaction, and counteraction dynamics. The staff analyzes each selected event. They identify tasks that the force must accomplish one echelon down, using assets two echelons down. Identifying each COA’s strengths and weaknesses allows the staff to adjust them as necessary.

3-180. The war game follows an action-reaction-counteraction cycle. *Actions* are those events initiated by the side with the initiative (normally the force on the offensive). *Reactions* are the other side's actions in response. *Counteractions* are the first side's responses to reactions. This sequence of action-reaction-counteraction is continued until the critical event is completed or until the commander determines that he must use another COA to accomplish the mission.

3-181. The staff considers all possible forces, including templated enemy forces outside the AO that can influence the operation. The staff evaluates each friendly move to determine the assets and actions required to defeat the enemy at that point. The staff continually considers branches to the plan that promote success against likely enemy counteractions. The staff lists assets used in the appropriate columns of the worksheet and lists the totals in the assets column (not considering any assets lower than two command levels down).

<b>Critical Event: <u>Aviation Deep Attack</u></b>	
<b>Sequence #</b>	
<b>Action</b>	<b>AVN BDE attacks to destroy enemy reserve on OBJ DEBRA.</b>
<b>Reaction</b>	<b>Anti-air ambush in route.</b>
<b>Counteraction</b>	<b>J/SEAD change air axis.</b>
<b>Assets</b>	<b>1-78 FA (MLRS), 1-222 (AHB), Fixed-Wing</b>
<b>Time</b>	<b>H-2 to H + 1</b>
<b>Decision Point</b>	<b>DP 3b and 3c</b>
<b>CCIR</b>	<b>Location of enemy armor reserve south of PL Kansas</b>
<b>Control Measures</b>	<b>Air Axis Falcon and Eagle</b>
<b>Remarks</b>	

**Figure 3-17. Sketch Note Work Sheet**

3-182. The commander and staff examine many areas in detail during the war game. These include—

- All enemy capabilities.
- Movement considerations.
- Closure rates.
- Lengths of columns.
- Formation depths.
- Ranges and capabilities of weapon systems.
- Desired effects of fires.

They consider how to create conditions for success, protect the force, and shape the battlefield. Experience, historical data, SOPs, and doctrinal literature provide much of the necessary information. During the war game, staff officers perform a risk assessment for their functional area for each COA and propose appropriate controls.

3-183. The staff continually assesses the risk to friendly forces from catastrophic threat, seeking a balance between mass and dispersion. When assessing WMD risk to friendly forces, planners view the target that the force presents through the eyes of an enemy target analyst. They consider ways to reduce vulnerability and determine the appropriate MOPP (mission-oriented protective posture) level consistent with mission accomplishment. They also consider deployment of nuclear, biological, and chemical (NBC) decontamination units.

3-184. The staff identifies the BOS assets required to support the concept of operations, including those needed to synchronize sustaining operations. If requirements exceed available assets, the staff recommends priorities based on the situation, commander's intent, and planning guidance. To maintain flexibility, the commander may decide to withhold some assets for unforeseen tasks or opportunities (a reserve).

3-185. The commander can modify any COA based on how things develop during the war game. When doing this, the commander validates the composition and location of the decisive operation, shaping operations, and reserve forces. Control measures are adjusted as necessary. The commander may also identify situations, opportunities, or additional critical events that require more analysis. The staff performs this analysis quickly and incorporates the results into the war game record.

3-186. An effective war game results in the commander and staff—

- Refining or modifying each COA, including identifying branches and sequels that become on-order or be-prepared missions.
- Refining the locations and times of decisive points.
- Identifying key or decisive terrain and determining how to use it.
- Refining the enemy event template and matrix.
- Refining the task organization, including forces retained in general support.
- Identifying tasks the unit retains and tasks assigned to subordinates.
- Allocating assets to subordinate commanders to accomplish their missions.
- Developing decision points.
- Developing a synchronization matrix.
- Developing decision support template.
- Estimating the duration of the entire operation and each critical event.
- Projecting the percentage of enemy forces defeated in each critical event, and overall.
- Identifying likely times and areas for enemy use of WMD and friendly NBC defense requirements.
- Identifying the potential times or locations for committing the reserve.



- Identifying the most dangerous enemy COA.
- Identifying locations for the commander, command posts, and INFOSYS nodes.
- Identifying critical events.
- Identifying requirements for BOS support.
- Determining requirements for military deception and surprise.
- Refining C2 requirements, including control measures and updated operational graphics.
- Refining CCIR and IR—including the LTIOV—and incorporating them into the ISR plan and Information Management plans.
- Developing the ISR plan and graphics.
- Developing IO objectives and tasks (see FM 3-13).
- Developing fire support, engineer, air defense, IO, and CSS plans and graphic control measures.
- Identifying the effects of friendly and enemy action on the civilian population and infrastructure, and how these will affect military operations.
- Identifying or confirming the locations of NAIs, TAIs, decision points, and IR needed to support them.
- Determining the timing for concentrating forces and starting the attack or counterattack.
- Determining movement times and tables for critical assets, including INFOSYS nodes.
- Identifying, analyzing, and evaluating strengths and weaknesses of each COA.
- Integrating targeting into the operation, to include identifying or confirming high-payoff targets and establishing attack guidance.
- Identifying hazards, assessing their risk, developing controls for them, and determining residual risk.

### **War-game Briefing (Optional)**

3-187. Time permitting, the staff delivers a briefing to ensure everyone understands the results of the war game. This briefing is normally not given to the commander. The staff uses it for review and ensures that all relevant points of the war game are captured for presentation to the commander (chief of staff/executive officer or deputy/assistant commander) in the COA decision briefing. In a collaborative environment, the briefing may include selected subordinate staffs. A war-game briefing format includes the following:

- Higher headquarters mission, commander's intent, and military deception plan.
- Updated IPB.
- Friendly and enemy COAs that were war gamed, to include—
  - Critical events.
  - Possible enemy actions and reactions.
  - Modifications to the COAs.
  - Strengths and weaknesses.
  - Results of the war game.

- Assumptions.
- War gaming technique used.

**COURSE OF ACTION COMPARISON**

3-188. The COA comparison starts with all staff members analyzing and evaluating the advantages and disadvantages of each COA from their perspectives (see Figure 3-18). Staff members each present their findings for the others’ consideration. Using the evaluation criteria developed before the war game, the staff outlines each COA, highlighting its advantages and disadvantages. Comparing the strengths and weaknesses of the COAs identifies their advantages and disadvantages with respect to each other.

3-189. The staff compares feasible COAs to identify the one with the highest probability of success against the most likely enemy COA and the most dangerous enemy COA. The selected COA should also—

- Pose the minimum risk to the force and mission accomplishment.
- Place the force in the best posture for future operations.
- Provide maximum latitude for initiative by subordinates.
- Provide the most flexibility to meet unexpected threats and opportunities.

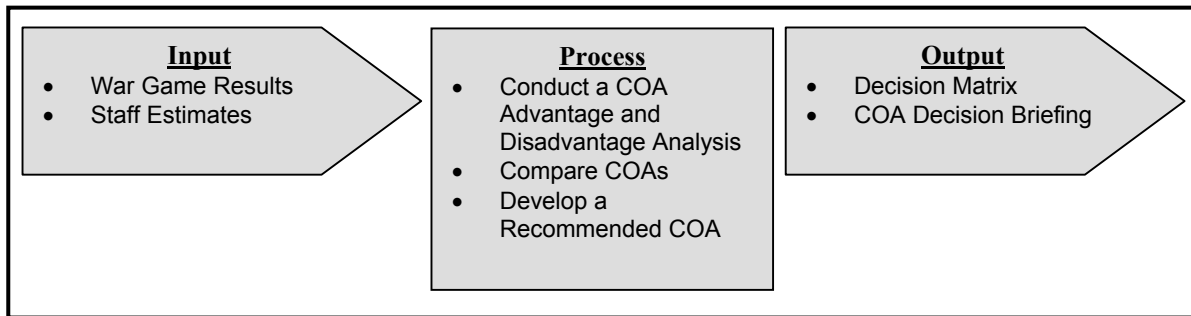

**Figure 3-18. COA Comparison**

3-190. Actual comparison of COAs is critical. The staff may use any technique that facilitates reaching the best recommendation and the commander making the best decision. The most common technique is the decision matrix, which uses evaluation criteria to assess the effectiveness and efficiency of each COA (see Figure 3-19).

3-191. Staff officers may each use their own matrix to compare COAs with respect to their functional areas. Matrices use the evaluation criteria developed before the war game. Decision matrices alone cannot provide decision solutions. Their greatest value is providing a method to compare COAs against criteria that, when met, produce battlefield success. They are analytical tools that staff officers use to prepare recommendations. Commanders provide the solution by applying their judgment to staff recommendations and making a decision.

3-192. The chief of staff/executive officer normally determines the weight of each criterion based on its relative importance and the commander’s guidance. The commander may give guidance that results in weighting certain criteria. The staff member responsible for a functional area scores each COA

using those criteria. Multiplying the score by the weight yields the criterion's value. The staff member then totals all values. However, he must be careful not to portray subjective conclusions as the results of quantifiable analysis. Comparing COAs by category is more accurate than comparing total scores.

### **COURSE OF ACTION APPROVAL**

3-193. COA approval has three components:

- The staff recommends a COA, usually in a decision briefing.
- The commander decides which COA to approve.
- The commander issues the final planning guidance.

CRITERIA (note 1)	WEIGHT (note 2)	COA 1 (note 3)	COA 2 (note 3)	COA 3 (note 3)
Maneuver	3	2 (6)	3 (9)	1 (3)
Simplicity	3	3 (9)	1 (3)	2 (6)
Fires	4	2 (8)	1 (4)	3 (12)
Intelligence	1	3 (3)	2 (2)	1 (1)
ADA	1	1 (1)	3 (3)	2 (2)
Mobility/ Survivability	1	3 (3)	2 (2)	1 (1)
CSS	1	2 (2)	1 (1)	3 (3)
C2	1	1 (1)	2 (2)	3 (3)
Residual Risk	2	1 (2)	2 (4)	3 (6)
IO	1	2 (2)	1 (1)	3 (3)
<b>TOTAL/ Weighted TOTAL</b>		20 (37)	18 (31)	22 (40)

**NOTES:**

1. Criteria are those assigned in step 5 of COA analysis.  
 2. The chief of staff/executive officer may emphasize one or more criteria by assigning weights to them based on their relative importance.  
 3. COAs are those selected for war-gaming.  
 Procedure: The staff assigns numerical values for each criterion after war-gaming the COA. Values reflect the relative advantages or disadvantages of each criterion for each COA action. The lowest number is best. The initially assigned score in each column is multiplied by the weight and the product put in parenthesis in the column. When using weighted value, the lower value assigned indicates the best option. The numbers are totaled to provide a subjective evaluation of the best COA without weighting one criterion over another. The scores are then totaled to provide a "best" (lowest number value) COA based on weights the commander assigns. Although the lowest value denotes the best solution, the best solution may be more subjective than the objective numbers indicate. The matrix must be examined for sensitivity. For example, COA 2 is the "best" COA, however, it may not be supportable from a ADA standpoint. The decision maker must either determine if he can acquire additional support or if he must alter or delete the COA.

**Figure 3-19. Sample Decision Matrix—Numerical Analysis**

**Course of Action Decision Briefing**

3-194. After completing its analysis and comparison, the staff identifies its preferred COA and makes a recommendation. If the staff cannot reach a decision, the chief of staff/executive officer decides which COA to recommend. The staff then delivers a decision briefing to the commander. The chief of staff/executive officer highlights any changes to each COA resulting from the war game. The decision briefing includes—

- The intent of the higher and next higher commanders.
- The status of the force and its components.
- The current IPB.
- The COAs considered, including—

- Assumptions used.
  - Results of staff estimates.
  - Summary of war-game for each COA to include critical events, modifications to any COA, and war game results.
  - Advantages and disadvantages (including risk) of each COA. These may be discussed in terms of a numerical analysis (see Figure 3-19), subjective analysis (see Figure 3-20), or broad categories (see Figure 3-21).
- The recommended COA.

Course of Action	Advantages	Disadvantages
<b>COA 1</b>	Decisive operation avoids major terrain obstacles. Adequate maneuver room for decisive operation and reserve.	Decisive operation faces stronger resistance at beginning.
<b>COA 2</b>	Decisive operation gains good observation early. Shaping operation provides flank protection to the decisive operation.	Initially, reserve may have to be employed in AO of shaping operation. Needs detailed and rehearsed procedural and positive controls.
<b>DISCUSSION:</b>		

**Figure 3-20. Sample Decision Matrix—Subjective Analysis**

Factors	Course of Action	
	1	2
<b>Casualty estimate</b>	+	-
<b>Medical evacuation routes</b>	-	+
<b>Suitable location for medical facilities</b>	0	0
<b>Available EPW facilities</b>	-	+
<b>Suitable command post locations</b>	-	+
<b>Courier and distribution routes</b>	-	+
<b>Effects of attachments and detachments on force cohesion, casualty reporting, and replacement operations</b>	-	+
<b>Residual Risk</b>	+	-
<b>NOTE:</b> The factors in the above example are neither all-inclusive nor always applicable.		

**Figure 3-21. Sample Decision Matrix—Broad Categories**

### Commander's Decision

3-195. After the decision briefing, the commander selects the COA he believes will best accomplish the mission. If the commander rejects all COAs, the staff starts COA development again. If the commander modifies a proposed COA or gives the staff an entirely different one, the staff war-games it and presents the results to the commander with a recommendation.

## Final Planning Guidance

3-196. After selecting a COA, the commander issues the final planning guidance. The final planning guidance includes a refined commander's intent (if necessary) and new CCIR to support execution. It also includes any additional guidance on priorities for BOS activities, orders preparation, rehearsal, and preparation. This guidance includes priorities for resources needed to preserve freedom of action and assure continuous CSS.

3-197. Commanders include risk they are willing to accept in the final planning guidance. If there is time, commanders discuss acceptable risk with adjacent, subordinate, and senior commanders, often by VTC. However, a commander must obtain the higher commander's approval to accept any risk that might imperil accomplishing the higher commander's mission.

3-198. Based on the commander's decision and final planning guidance, the staff issues a WARNO to subordinate headquarters. This WARNO contains the information subordinate units need to refine their plans. It confirms guidance issued in person or by VTC and expands on details not covered by the commander personally. The WARNO issued after COA approval normally contains:

- Mission.
- Commander's intent.
- Updated CCIR and EEFL.
- Concept of operations.
- AO.
- Principal tasks assigned to subordinate units.
- Preparation and rehearsal instructions not included in standing operating procedures (SOP).
- Final time line for the operations.

## ORDERS PRODUCTION

3-199. The staff prepares the order or plan by turning the selected COA into a clear, concise concept of operations and required supporting information. The concept of operations for the approved COA becomes the concept of operations for the plan. The COA sketch becomes the basis for the operation overlay. Orders and plans provide all information subordinates need for execution. Mission orders avoid unnecessary constraints that inhibit subordinate initiative. The staff assists subordinate staffs with their planning and coordination.

3-200. During orders production, the staff implements risk controls by coordinating and integrating them into the appropriate paragraphs and graphics of the order. The order communicates how to put controls into effect, which implements them, and how they fit into the overall operation.

3-201. Commanders review and approve orders before the staff reproduces and disseminates them unless they have delegated that authority. Traditionally, the chief of staff/executive officer or operations officer receives it. If possible, the order is briefed to subordinate commanders face to face by the higher commander and staff. The commander and staff conduct

confirmation briefings with subordinates immediately afterwards. Confirmation briefings can be done collaboratively with several commanders at the same time, or with single commanders. They may be performed face to face or by VTC.

## PLANNING IN A TIME-CONSTRAINED ENVIRONMENT

3-202. The focus of any planning processes should be to quickly develop a flexible, tactically sound, and fully integrated and synchronized plan. However, any operation may “outrun” the initial plan. The most detailed estimates cannot anticipate every possible branch or sequel, enemy action, unexpected opportunities, or changes in mission directed from higher headquarters. Fleeting opportunities or unexpected enemy action may require a quick decision to implement a new or modified plan. When this occurs, unit’s often find themselves pressed for time in developing a new plan.

3-203. Before a unit can effectively conduct planning in a time-constrained environment, it must master the steps in the full MDMP. A unit can only shorten the process if it fully understands the role of each and every step of the process and the requirement to produce the necessary products. Training on these steps must be thorough and result in a series of staff battle drills that can be tailored to the time available.

3-204. Staffs must be able to produce simple, flexible, tactically sound plans in a time-constrained environment. Any METT-TC factor, but especially limited time, may make it difficult to complete every MDMP step in detail. Applying an inflexible process to all situations will not work. Anticipation, organization, and prior preparation are the keys to successful planning under time-constrained conditions.

3-205. Planning in a time-constrained environment is based on the full MDMP. The MDMP is a sound and proven process that can be modified with slightly different techniques to be effective when time is limited. The rest of this chapter discusses how to abbreviate the MDMP for use under time-constrained conditions. In these situations, commanders shorten the process, however,

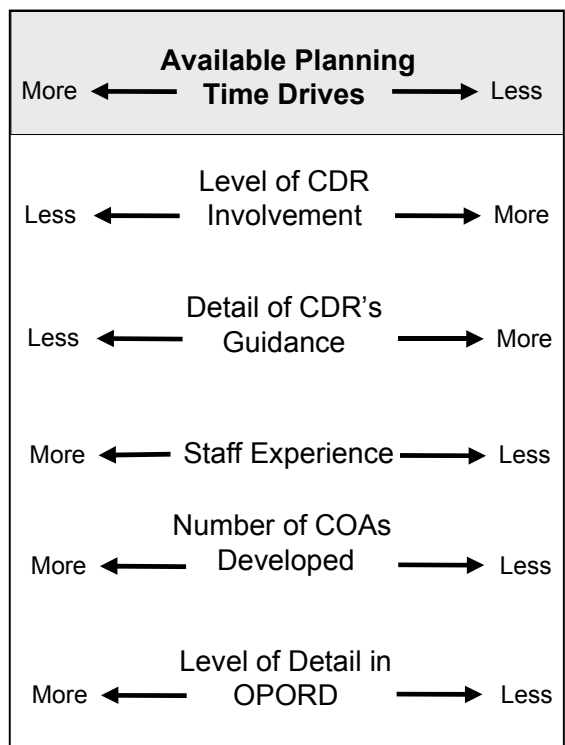

Figure 3-21. Planning Continuum

there is still only one process. Omitting steps of the MDMP is not a solution.

3-206. The steps of an abbreviated MDMP are the same as those for the full process; however, the commander performs many of them mentally or with less staff involvement. The products developed during an abbreviated MDMP may be the same as those developed for the full process; however, they are usually less detailed. Some may be omitted altogether. Unit SOPs state how to abbreviate the MDMP based on the commander's preferences.

3-207. The advantages of abbreviating the MDMP are—

- It maximizes the use of available time.
- It allows subordinates more planning time.
- It focuses staff efforts on the commander's guidance.
- It facilitates adapting to a rapidly changing situation.
- It allows for the commander's experience to compensate for an inexperienced staff.

3-208. The disadvantages of abbreviating the MDMP are—

- It is much more directive and limits staff flexibility and initiative.
- It does not explore all available options when developing friendly COAs.
- It increases the risk of overlooking a key factor or not uncovering a significantly better option.
- It may decrease coordination and synchronization of the plan.

3-209. The time saved on any MDMP step can be used to—

- Refine the plan more thoroughly.
- Conduct a more deliberate and detailed war game.
- Consider potential branches and sequels in detail.
- Focus more on rehearsing and preparing the plan.
- Allow subordinates units more planning and preparations time.

## THE COMMANDER'S ROLE

3-210. The commander decides how to adjust the MDMP, giving specific guidance to the staff to focus on the process and save time. Commanders who have access to only a small portion of the staff, or none at all, rely even more than normal on their own expertise, intuition, and creativity, and on their understanding of the environment and of the art and science of warfare. They may have to select a COA, mentally war-game it, and confirm their decision to the staff in a relatively short time. If so, the decision is based more on experience than on a formal integrated staff process.

3-211. Commanders avoid changing their guidance unless a significantly changed situation requires major revisions. Frequent minor changes to the guidance can easily result in lost time as the staff makes constant minor adjustments to the plan.

3-212. Commanders consult with subordinate commanders before making a decision, if possible. Subordinate commanders are closer to the fight and can more accurately describe the enemy and friendly situations. Additionally, consulting with subordinates gives commanders insight into the upcoming



operation and allows parallel planning. White boards and collaborative digital means of communicating greatly enhance parallel planning.

3-213. In situations where commanders must decide quickly, they advise their higher headquarters of the selected COA, if time is available. However, commanders do not let an opportunity pass because they cannot report their actions.

## THE STAFF'S ROLE

3-214. The importance of staff estimates increases as time decreases. Decision making in a time-constrained environment almost always takes place after a unit has entered the AO and begun operations. This means that the IPB, an updated common operational picture, and some portion of staff estimates should already exist. Detailed planning provides the basis for information the commander and staff need to make decisions during execution. Staff members keep their running estimates current so, when planning time is limited, they can provide accurate, up-to-date assessments quickly and move directly into COA development. Under time-constrained conditions, commanders and staffs use as much of the previously analyzed information and products from earlier decisions as possible.

## DECISION MAKING TIME-SAVING TECHNIQUES

3-215. Commanders shorten the MDMP when there is not enough time to perform each step in detail. The most significant factor to consider is time. It is the only nonrenewable, and often the most critical, resource.

### General Techniques

3-216. There are several general time-saving techniques that may be used to speed up the planning process. These techniques include—

- **Maximize Parallel Planning.** Although parallel planning is the norm, maximizing its use in time-constrained environments is critical. In a time-constrained environment, the importance of WARNOs increases as available time decreases. A verbal WARNO now followed by a written order later saves more time than a written order one hour from now. The same WARNOs used in the full MDMP should be issued when abbreviating the process. In addition to WARNOs, units must share all available information with subordinates, especially IPB products, as early as possible. The staff uses every opportunity to perform parallel planning with the higher headquarters and to share information with subordinates (see Chapter 1).
- **Increase Collaborative Planning.** Planning in real time with higher headquarters and subordinates improves the overall planning effort of the organization (see Chapter 1). Modern INFOSYS and a COP shared electronically allow collaboration with subordinates from distant locations and can increase information sharing and improve the commander's visualization. Additionally, taking advantage of subordinate input and their knowledge of the situation in their AO often results in developing better COAs faster.
- **Use Liaison Officers.** LOs posted to higher headquarters allow the command to have representation in their higher headquarters

planning secession. LO assist in passing timely information to their parent headquarters and can speed up the planning effort both for the higher and own headquarters.

- **Increase Commander's Involvement.** While commander's can not spend their all their time with the planning staff, the greater the commander's involvement in planning, the faster the staff can plan. In time-constrained conditions, commander's who participate in the planning process can make decisions (such as COA selection), without waiting for a detailed briefing from the staff. The first timesaving technique is to increase the commander's involvement. This technique allows commanders to make decisions during the MDMP without waiting for detailed briefings after each step.
- **Limit the Number of COAs to Develop.** Limiting the number of COAs developed and war-gamed can save a large amount of planning time. If time is extremely short, the commander can direct development of only one COA. In this case, the goal is an acceptable COA that meets mission requirements in the time available, even if the COA is not optimal. This technique saves the most time.

## SPECIFIC TIME-SAVING TECHNIQUES DURING THE MDMP

### Receipt of Mission

3-217. The tasks performed during mission receipt do not change in a time-constrained environment. In all situations, commanders decide whether or not to abbreviate the process and, if so, specific how they want to do it.

### Mission Analysis

3-218. The commander's involvement is the key to saving time during mission analysis. If there is not enough time for a detailed mission analysis, the commander, staff, and subordinate commanders (if collaborative tools are available) perform a rapid mission analysis. They determine the restated mission based on intuitive decisions and whatever information is available. In extreme circumstances, the commander and key staff may perform mission analysis mentally. This should be the exception rather than the norm.

3-219. IPB requires constant attention. Many delays during mission analysis can be traced to it. In a time-constrained environment, the intelligence officer quickly updates the IPB based on the new mission and changed situation. A current intelligence estimate allows ISR assets to deploy early to collect information to confirm adjustments to the initial plan. Enemy event templates must be as complete as possible before the mission analysis briefing. Because they are the basis for war-gaming, they must be constantly updated as new information becomes available.

3-220. The staff performs as formal a mission analysis briefing as time allows. However, staff members may have to brief their estimates orally, without the use of charts or other tools, covering only information that has changed from the last staff estimate. When severely time-constrained, they brief only vital information that directly affects the new mission.

Commanders who have been directly involved in mission analysis may decide to skip the mission analysis briefing.

3-221. Issuing detailed commander's guidance is one way to save time during mission analysis. The elements of the commander's guidance may be the same as the full MDMP, but the guidance is much more directive. Detailed guidance may include outlining what the commander expects in each COA. It may include a tentative task organization and concept of operations. Commanders may also determine which enemy COAs they want friendly COAs war-gamed against as well as the branches or sequels to incorporate into each. Detailed guidance keeps the staff focused by establishing parameters within which to work.

3-222. Commander's guidance must be constantly reviewed and analyzed. As the situation changes and information becomes available, commanders may need to update or alter their guidance. Once the guidance is issued, the staff immediately sends a WARNO to subordinate units. If subordinate commanders and staffs are part of a collaborative process, they receive this updated guidance during the collaborative session. Even so, the staff captures this guidance and disseminates it in a WARNO.

### **Course of Action Development**

3-223. Increased commander involvement in COA development saves a significant amount of time. It results in detailed and directive commander's guidance. The greatest saving comes when the commander directs development of only a few COAs instead of many.

3-224. Performing a hasty war game at the end of COA development can save time. A hasty war game allows commanders to determine if they favor one or more of the proposed COAs. It develops and matures one or more COAs prior to the formal war game. If the commander cannot be present during the hasty war game, the staff delivers a COA backbrief to the commander afterwards. From the hasty war game, the commander refines one or more COAs before the detailed war game. In extreme situations, this may be the only opportunity to conduct a war game.

3-225. Commanders may also use a hasty war game to select a single COA for further development. Such a decision allows the staff and subordinates to focus on one COA rather than several. It also lets the staff concentrate on synchronizing the COA earlier.

3-226. The fastest way to develop a plan is for the commander to direct development of one COA with branches against the most likely enemy COA. The technique should be used only when time is severely limited. This choice of COA is often intuitive, relying on the commander's experience and judgment. The commander determines which staff officers are essential to assist in COA development depending on the type of operation being planned. The minimum is normally the intelligence officer, operations officer, fire support coordinator, engineer coordinator, and chief of staff/executive officer. The commander may also include subordinate commanders, if available, either in person or by VTC. This team quickly develops a flexible COA that it feels will accomplish the mission. The commander mentally war-games it and gives it to the staff to refine.

3-227. Limiting the number of COAs incurs the risk of overlooking a significantly better COA. Developing only one COA is the most risky approach. It provides the staff with the least flexibility to apply its creativity and explore alternate COAs, but it gives staff and subordinates more time to synchronize the plan. However, sometimes during synchronization, a modification to the COA is found that will enhance the plan without major disruptions in preparation. If this occurs, it is incumbent upon the staff to bring it to the commander immediately for decision.

3-228. Saving time by not using the enemy event templates to develop COAs is a poor technique. Without them, commanders and staffs cannot perform the analysis of relative combat power and the initial arraying of forces.

### Course of Action Analysis

3-229. The commander and staff fully war-game a limited number of COAs to ensure all elements are fully integrated and synchronized. An early decision to limit the number of COAs war-gamed, or to develop only one COA, saves the greatest amount of time. It is best to war-game friendly COAs against all feasible enemy COAs. However, war-gaming against a smaller number of enemy COAs can save additional time. As a minimum, the decisive operation is war-gamed against the most likely enemy COA.

3-230. The commander's involvement can save significant time in COA analysis by focusing the staff on the essential aspects of the war game. The commander can supervise the war game and make decisions, provide guidance, and delete unsatisfactory concepts. If time is available to war-game multiple COAs, the commander may identify the COA he favors. Unwanted COAs are then discarded and the time allocated to refining the selected COA.

3-231. The commander always assesses risk during COA analysis. Limiting the number of COAs may increase risk to the command. Commanders evaluate all COAs to ensure they will not render the force incapable of anticipated operations or lower the unit's combat effectiveness beyond acceptable levels.

3-232. The box technique is best for an abbreviated MDMP. It addresses the decisive operation first. If time permits, the staff war-games other critical events or boxes. Commanders identify and prioritize the events they want analyzed. Analyzing essential tasks can identify critical events.

3-233. Staff officers save time if they specifically define and limit the evaluation criteria before they begin the war game. The commander can greatly increase effectiveness here by specifying the critical factors and their weight. Significant factors are quantified, if possible, and limited to the four or five most important, based on the mission statement, commander's intent, and the initial planning guidance.

3-234. The staff supports the commander's plan. However, as the staff refines the plan, it cannot become so biased that it develops a plan that is infeasible and unsupportable. If the staff determines that the COA the commander selected cannot be supported, they develop a new COA.

3-235. When only one COA is developed, the purpose of COA analysis is to verify, refine, and synchronize the COA, and integrate recommended modifi-

cations into it as necessary. However, the analysis should follow the formal war game process as much as time allows helping the commander visualize the outcome and identify potential branches and sequels. As time allows, the staff can further war-game and develop these branches and sequels.

3-236. In a severely time-constrained environment and if automated tools allow, units may combine the war game with the rehearsal in a virtual environment that includes subordinate commanders and staffs. A significant benefit of this technique is that it allows subordinate commanders to control their units during the war game.

### **Course of Action Comparison**

3-237. If the commander decides to war-game only one COA, or if he chooses one COA during the war game, no COA comparison is needed. If multiple COAs have been war-gamed and the commander has not made a decision, the staff must perform a COA comparison (see paragraphs 3-188–3-192). Limiting the evaluation criteria and weighting factors is the only significant shortcut in this step.

### **Course of Action Approval**

3-238. If the commander has observed and participated in the planning process the commander can make an immediate decision at the end of COA comparison. If the commander has not participated in the process or has not made a decision, a decision briefing is required. Good COA comparison charts and sketches help the commander visualize and distinguish among the COAs. The staff ensures all COAs are complete, with tentative task organizations, concepts of operations, and tasks and purposes for each subordinate unit. Limiting the COA briefing to only the decisive operation or critical points can also save time. If only one COA was developed, no decision is required, unless the developed COA becomes unsuitable, infeasible, or unacceptable. If this occurs, the staff develops another COA.

### **Orders Production**

3-239. In a time-constrained environment, time is important and a verbal FRAGO may be issued immediately after the commander makes a COA decision. The staff follows the verbal FRAGO with a written order as soon as possible. If a verbal order is not issued, the staff immediately sends out a WARNO, followed as quickly as possible by a written order. In all cases, the staff captures all the information in verbal orders and WARNOs, and produces a written order to follow up on any previously issued orders.



## Chapter 4

# Troop Leading Procedures

Troop leading procedures (TLP) provide small unit leaders a framework for planning and preparing for operations. Leaders of company and smaller units use TLP to develop plans and orders. This chapter describes the eight steps of TLP and its relationship to the military decision making process (MDMP). While TLP is explained in this chapter from a ground maneuver perspective, it is applicable to all types of small units. Formats for plans and orders are located at Appendix G.

### TROOP LEADING PROCEDURES AND MILITARY DECISION MAKING PROCESS

4-1. TLP extend the MDMP to small unit level. The MDMP and TLP are similar but not identical. They are both linked by the basic problem solving methodology explained in Chapter 2. Commanders with a coordinating staff use the MDMP as their primary planning process. Company-level and smaller units do not have formal staffs and use TLP to plan and prepare for operations. This places the responsibility for planning primarily on the commander or small unit leader.

4-2. ***Troop leading procedures is a dynamic process used by small unit leaders to analysis a mission, develop a plan, and prepare for an operation.*** These procedures enable leaders to maximize available planning time while developing effective plans and adequately preparing their unit for an operation. TLP consist of the eight steps as depicted in Figure 4-1. The sequence of the TLP steps is not rigid. They are modified to meet the mission, situation, and available time. Some steps are done concurrently while others may go on continuously throughout the operations.

#### Troop Leading Procedures Steps

1. Receive the mission.
2. Issue a warning order.
3. Make a tentative plan.
4. Initiate movement.
5. Conduct reconnaissance.
6. Complete the plan.
7. Issue the order.
8. Supervise and refine.

Figure 4-1.

#### CONTENTS

<b>Troop Leading Procedures and Military Decision Making Process.....</b>	<b>4-1</b>	<b>Initiate Movement.....</b>	<b>4-12</b>
<b>Performing Troop Leading Procedures.....</b>	<b>4-4</b>	<b>Conduct Reconnaissance.....</b>	<b>4-12</b>
<b>Receive the Mission.....</b>	<b>4-4</b>	<b>Complete the Plan.....</b>	<b>4-12</b>
<b>Issue a Warning Order.....</b>	<b>4-5</b>	<b>Issue the Order.....</b>	<b>4-13</b>
<b>Make a Tentative Plan.....</b>	<b>4-6</b>	<b>Supervise and Refine.....</b>	<b>4-13</b>

4-3. Leaders use TLP when working alone to solve tactical problems or with a small group. For example, a company commander may use his executive officer, first sergeant, fire support officer, supply sergeant and communications sergeant to assist him during TLP.

4-4. The type, amount, and timeliness of the information passed from higher to lower headquarters directly impact the lower unit leader's TLP. Figure 4-2 illustrates the parallel sequences of the MDMP of a battalion with the TLP of a company and a platoon. The solid arrows depict when a higher headquarters' planning event could start TLP of a subordinate unit. However, events do not always occur in the order shown. For example, TLP may start with receipt of a warning order (WARNO), or it may not start until the higher headquarters has completed the MDMP and issues an operation order (OPORD). WARNOs from higher headquarters may arrive at any time during TLP. Army leaders remain flexible. They adapt TLP to fit the situation rather than try to alter the situation to fit a preconceived idea of how events should flow.

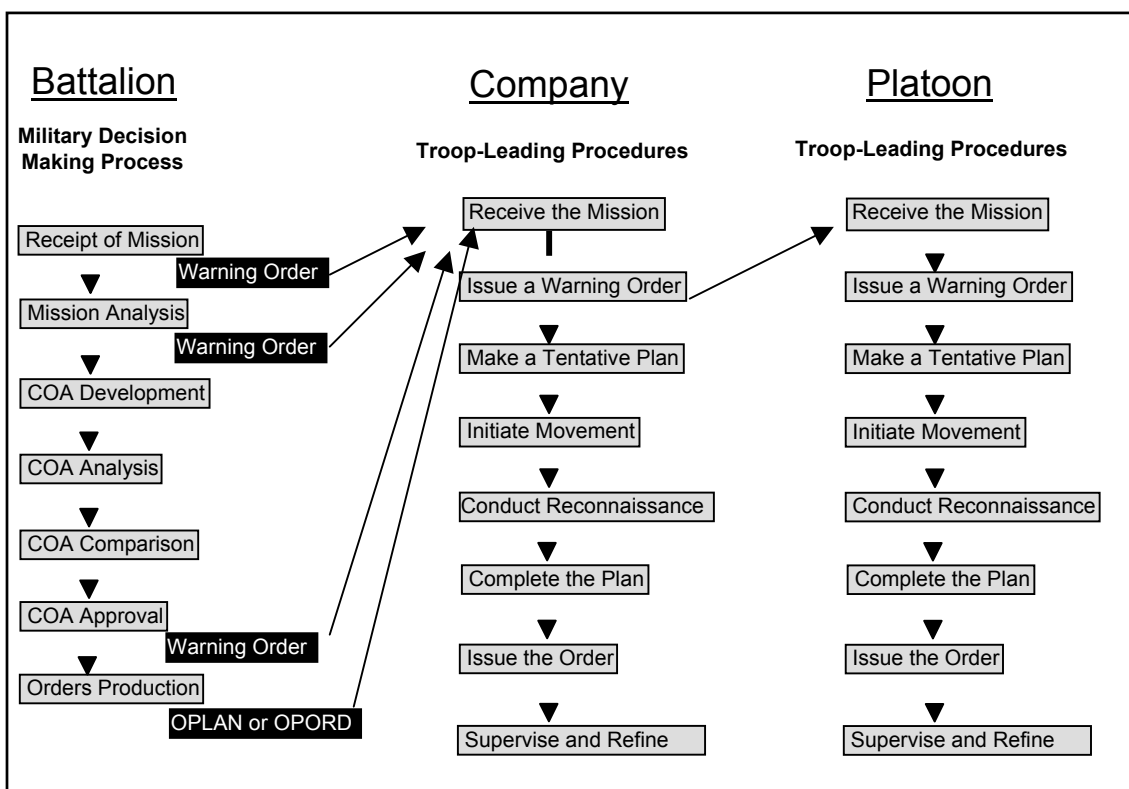

Figure 4-2. Parallel Planning

4-5. Normally the first three steps (receive the mission, issue a WARNO, and make a tentative plan) of TLP occur in order. However, the sequence of subsequent steps is based on the situation. The tasks involved in some steps (for example, initiate movement and conduct reconnaissance) may occur several times. The last step, supervise and refine, occurs throughout.



4-6. There is a tension between executing current operations and planning for future operations. The small unit leader must balance both. If engaged in a current operation, there is less time for TLP. If in a lull, transition, or an assembly area, there is more time and therefore more time to do a thorough job of TLP. In some situations, time constraints or other factors may prevent Army leaders from performing each step of TLP as thoroughly as they would like. For example, during the step “make a tentative plan”, small unit leaders often develop only one acceptable course of action (COA) vice multiple COAs. If time permits however, leaders may develop, compare, and analyze several COAs before arriving at a decision on which one to execute.

4-7. Ideally, a battalion headquarters issues at least three WARNOs to subordinates when conducting the MDMP as depicted in Figure 4-2. WARNOs are issued upon receipt of mission, completion of mission analysis, and when the commander approves a COA. However, the number of WARNOs is not fixed. WARNOs serve a function in planning similar to that of fragmentary orders (FRAGOs) during execution. Commanders may issue a WARNO whenever they need to disseminate additional planning information or initiate necessary preparatory action, such as movement or reconnaissance.

4-8. The first WARNO normally contains minimal information. It alerts leaders that a new mission is pending. This WARNO normally contains the following information:

- The type of operation.
- The general location of the operation.
- The initial operational time line.
- Any movements to initiate.
- Any collaborative planning sessions directed by the commander.
- Initial information requirements (IR) or commander's critical information requirement (CCIR).
- Initial intelligence, surveillance, and reconnaissance (ISR) tasks.

4-9. The WARNO issued at the end of mission analysis contains essential information for planning, and directives to initiate movements and reconnaissance. Typically it includes—

- The approved unit mission statement.
- The commander's intent.
- Task organization changes.
- Attachments/detachments.
- The unit area of operations (AO) (sketch, overlay, or some other description).
- The CCIR and essential elements of friendly information (EEFI).
- Risk guidance.
- Surveillance and reconnaissance instructions.
- Initial movement instructions.
- Security operations.
- Military deception guidance.
- Mobility, countermobility, and survivability guidance.

- Specific priorities.
  - The updated operational time line.
  - Guidance on collaborative events and rehearsals.
- 4-10. The WARNO issued after COA approval normally contains—
- Mission.
  - Commander's intent.
  - Updated CCIR and EEFI.
  - Concept of operations.
  - Principal tasks assigned to subordinate units.
  - Preparation and rehearsal instructions not included in standing operating procedures (SOP).
  - Final time line for the operations.

4-11. Army leaders begin TLP when they receive the initial WARNO or perceive a new mission. As each subsequent order arrives, leaders modify their assessments, update tentative plans, and continue to supervise and assess preparations. In some situations, the higher headquarters may not issue the full sequence of WARNOs; security considerations or tempo may make it impractical. Commanders carefully consider decisions to eliminate WARNOs. Subordinate units need to always have enough information to plan and prepare for the operation. In other cases, Army leaders may initiate TLP before receiving a WARNO based on existing plans and orders (contingency plans or be-prepared missions), and an understanding of the situation.

4-12. Parallel planning hinges on distributing information as it is received or developed (see Chapter 1). Army leaders cannot complete their plans until they receive their unit mission. If each successive WARNO contains enough information, the higher headquarters' final order will confirm what subordinate leaders have already analyzed and put into their tentative plan. In other cases, the higher headquarters order may change or modify the subordinate's tasks enough that additional planning and reconnaissance is required.

## PERFORMING TROOP LEADING PROCEDURES

4-13. TLP provide small unit leaders a framework for planning and preparing for operations. This section discusses each step of TLP. Figure 4-3 depicts TLP along with key planning tasks. The box on the left shows the steps of TLP. The box in the middle (METT-TC) represents the initial METT-TC analysis that leaders conduct to develop an initial assessment. This occurs in steps 1 and 2 of TLP and is refined in plan development. The box on the right depicts plan development tasks. Plan development occurs in steps 3 through 6 of the TLP. These tasks are similar to the steps of the MDMP (see Chapter 3).

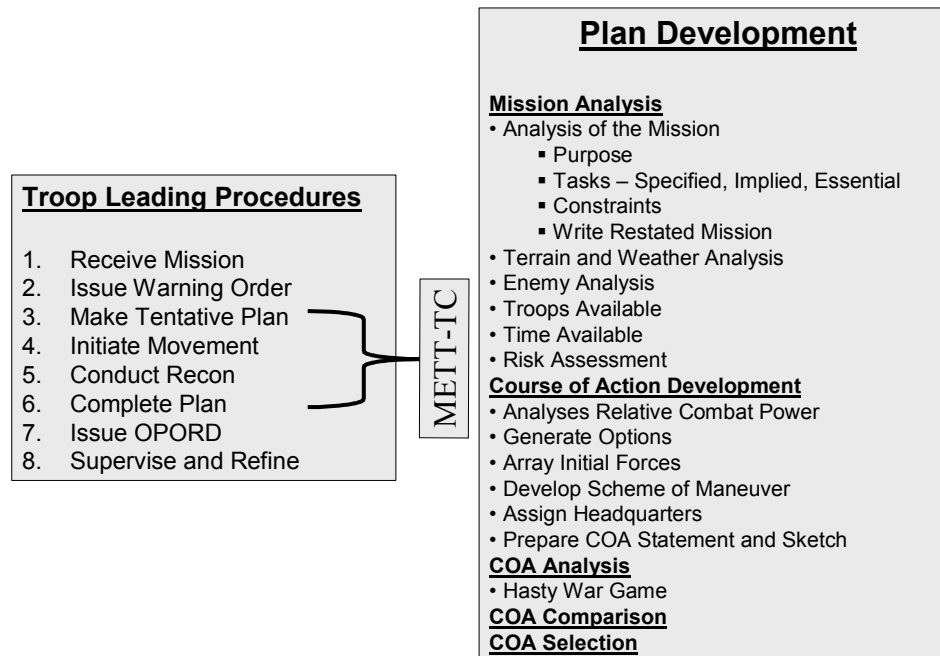

**Figure 4-3. Planning at Company and Below**

## RECEIVE THE MISSION

4-14. Receipt of a mission may occur in several ways. It may begin with the initial WARNO from higher or when a leader receives an OPORD. Frequently, leaders receive a mission in a FRAGO over the radio. Ideally, they receive a series of WARNOs, the OPORD, and a briefing from their commander. Normally after receiving an OPORD, leaders are required to give a confirmation brief to their higher commander to ensure they understand the higher commander's concept of operations and intent for his unit. The leader obtains clarification on any portions of the higher headquarters plan as required.

4-15. Upon receipt of mission, Army leaders perform an initial assessment of the situation (METT-TC analysis) and allocate the time available for planning and preparation. (Preparation includes rehearsals and movement.) This initial assessment and time allocation form the basis of their initial WARNO. Army leaders issue the initial WARNO quickly to give subordinates as much time as possible to plan and prepare.

## Perform an Initial Assessment

4-16. The initial assessment addresses the factors of mission, enemy, terrain and weather, troops and support available, time available, and civil considerations (METT-TC). The order and detail in which Army leaders analyze the factors of METT-TC is flexible. It depends on the amount of information available and the relative importance of each factor. For example, they may concentrate on the mission, enemy, and terrain, leaving weather and civil considerations until they receive more detailed information.

4-17. Often, Army leaders will not receive their final unit mission until the WARNO is disseminated after COA approval or after the OPORD. Effective leaders do not wait until their higher headquarters completes planning to begin their planning. Using all information available, Army leaders develop their unit mission as completely as they can. They focus on the mission, commander's intent, and concept of operations of their higher and next higher headquarters. They pick out the major tasks their unit will probably be assigned and develop a mission statement based on information they have received. At this stage, the mission may be incomplete. For example, an initial mission statement could be, "First platoon conducts an ambush in the next 24 hours." While not complete, this information allows subordinates to start preparations. Leaders complete a formal mission statement during TLP step 3 (make a tentative plan) and step 6 (complete the plan).

### **Allocate the Available Time**

4-18. Based on what they know, Army leaders estimate the time available to plan and prepare for the mission. They begin by identifying the times at which major planning and preparation events, including rehearsals, must be complete. Reverse planning helps them do this (see Chapter 1). Army leaders identify the critical times specified by higher headquarters and work back from them, estimating how much time each event will consume. Critical times might include aircraft loading times, the line of departure (LD) time, or the start point (SP) time for movement. By working backwards, Army leaders arrive at the time available to plan and prepare for the operation.

4-19. Leaders ensure that all subordinate echelons have sufficient time for their own planning and preparation needs. A general rule of thumb for leaders at all levels is to use no more than one-third of the available time for planning and issuance of the OPORD. Leaders allocate the remaining two-thirds of it to subordinates. Below is a sample time schedule for an infantry company. This tentative schedule is adjusted as TLP progresses.

- 0600 – Execute mission.
- 0530 – Finalize or adjust the plan based on leader's recon.
- 0400 – Establish the objective rallying point; begin leaders recon.
- 0200 – Begin movement.
- 2100 – Conduct platoon inspections.
- 1900 – Conduct rehearsals.
- 1800 – Eat meals (tray packs).
- 1745 – Hold backbriefs (squad leaders to platoon leaders).
- 1630 – Issue platoon OPORDs.
- 1500 – Hold backbriefs (platoon leaders to company commander).
- 1330 – Issue company OPORD.
- 1045 – Conduct reconnaissance.
- 1030 – Update company WARNO.
- 1000 – Receive battalion OPORD.
- 0900 – Receive battalion WARNO; issue company WARNO.

## ISSUE A WARNING ORDER

4-20. As soon as Army leaders finish their initial assessment of the situation and available time, they issue a WARNO. Leaders do not wait for more information. They issue the best WARNO possible with the information at hand and update it as needed with additional WARNOS.

4-21. The WARNO contains as much detail as possible. It informs subordinates of the unit mission and gives them the leader's time line. Army leaders may also pass on any other instructions or information they think will help subordinates prepare for the new mission. This includes information on the enemy, the nature of the higher headquarters plan, and any specific instructions for preparing their units. The most important thing is that leaders not delay in issuing the initial WARNO. As more information becomes available, leaders can—and should—issue additional WARNOS. By issuing the initial WARNO as quickly as possible, Army leaders enable their subordinates to begin their own planning and preparation.

4-22. WARNOS follow the five-paragraph OPORD format (see Appendix G). Normally an initial WARNO issued below battalion level includes—

- Mission or nature of the operation.
- Time and place for issuing the OPORD.
- Units or elements participating in the operation.
- Specific tasks not addressed by unit SOP.
- Time line for the operation.

## MAKE A TENTATIVE PLAN

4-23. Once they have issued the initial WARNO, Army leaders develop a tentative plan. This step combines MDMP steps 2 through 6: mission analysis, COA development, COA analysis, COA comparison, and COA approval. At levels below battalion, these steps are less structured than for units with staffs. Often, leaders perform them mentally. They may include their principal subordinates—especially during COA development, analysis, and comparison. However, Army leaders, not their subordinates, select the COA on which to base the tentative plan.

### Mission Analysis

4-24. To frame the tentative plan, Army leaders perform mission analysis. This mission analysis follows the METT-TC format, continuing the initial assessment performed in TLP step 1. FM 6-0 discusses the factors of METT-TC.

4-25. **Mission.** Army leaders analyze the higher headquarters WARNO or OPORD to determine how their unit contributes to the higher headquarters mission (see Chapter 1, Nested Concepts). They examine the following information that affects their mission:

- **Higher Headquarters Mission and Commander's Intent.** Army leaders determine the mission and commander's intent of their higher and next higher headquarters. When these are unavailable, Army leaders infer them based on the information they have. When they

receive the actual mission and commander's intent, they revise their plan, if necessary.

- **Higher Headquarters Concept of Operations.** Army leaders examine the concept of operations to determine how their unit's mission and tasks contribute to the higher mission's success. They determine details that will affect their operations, such as control measures and execution times.
- **Specified, Implied, and Essential Tasks.** From WARNOs and the OPORD, Army leaders extract the specified and implied tasks assigned to their unit. They determine why each task was assigned to their unit to understand how it fits within the commander's intent and concept of operations. From the specified and implied tasks, Army leaders identify essential tasks. These tasks must be completed to accomplish the mission. Failure to complete an essential task results in mission failure.
- **Constraints.** Army leaders also identify any constraints placed on their unit. Constraints can take the form of a requirement (for example, maintain a reserve of one platoon) or a prohibition on action (for example, no reconnaissance forward of Line Bravo before H-hour).

4-26. The product of this part of the mission analysis is the restated mission. The restated mission is a simple, concise expression of the essential tasks the unit must accomplish and the purpose to be achieved. The mission statement states who (the unit), what (the task), when (either the critical time or on order), where (location), and why (the purpose of the operation). See Chapter 3 for a detailed discussion of developing the unit's mission statement.

4-27. **Enemy.** With the restated mission as the focus, Army leaders continue the analysis with the enemy. For small unit operations, Army leaders need to know about the enemy's composition, disposition, strength, recent activities, ability to reinforce, and possible COAs. Much of this information comes from higher headquarters. Additional information comes from adjacent units and other Army leaders. Some information comes from the leader's experience. Army leaders determine how available information applies to their operation. They also determine what they do not know about the enemy, but should. They identify these intelligence gaps to their higher headquarters or take action (such as sending out reconnaissance patrols) to obtain the necessary information.

4-28. **Terrain and Weather.** This aspect of mission analysis addresses the military aspects of terrain: observation and fields of fire; avenue of approach; key terrain; obstacles; and cover and concealment (OAKOC).

- **Observation and Fields of Fire.** *Observation* is the condition of weather and terrain that permits a force to see the friendly, enemy, and neutral personnel and systems, and key aspects of the environment (FM 6-0). A *field of fire* is the area that a weapon or group of weapons may cover effectively from a given position (JP 1-02). Observation and fields of fire apply to both enemy and friendly weapons. Army leaders consider direct-fire weapons and the ability of observers to mass and adjust indirect fire.

- **Avenues of Approach.** An *avenue of approach* is an air or ground route of an attacking force of a given size leading to its objective or key terrain in its path (JP 1-02). Avenues of approach include overland, air, and underground avenues. Underground avenues are particularly important in urban operations.
- **Key Terrain.** *Key terrain* is any locality or area, the seizure or retention of which affords a marked advantage to either combatant in a given course of action (FM 6-0). Terrain adjacent to the AO may be key if its control is necessary to accomplish the mission.
- **Obstacles.** *Obstacles* are any obstruction designed or employed to disrupt, fix, turn, or block the movement of an opposing force, and to impose additional loss in personnel, time, and equipment on the opposing force. Obstacles can be natural, manmade, or a combination of both (JP 1-02). Obstacles include natural features, man-made structures, and military reinforcing obstacles, such as minefields.
- **Cover and Concealment.** *Cover* is protection from the effects of fires (FM 6-0). *Concealment* is protection from observation and surveillance (JP 1-02). Terrain that offers cover and concealment limits fields of fire. Army leaders consider friendly and enemy perspectives.

Although remembered as separate elements, Army leaders consider the military aspects of terrain together.

4-29. There are five military aspects of weather: visibility, winds, precipitation, cloud cover, and temperature/humidity (see FM 34-130). The consideration of their effects is an important part of the mission analysis. Army leaders review the forecasts and conclusions available from higher headquarters and develop their own conclusions on the effects of weather on the mission. The analysis considers the effects on soldiers, equipment, and supporting forces, such as air and artillery support. Army leaders identify the aspects of weather that can affect the mission. They focus on factors whose effects they can mitigate. For example, Army leaders may modify standing operating procedure (SOP) uniform and carrying loads based on the temperature. Small unit leaders include instructions on mitigating weather effects in their tentative plan. They check for compliance during preparation, especially during rehearsals.

4-30. **Troops and Support Available.** Perhaps the most important aspect of mission analysis is determining the combat potential of one's own force. Army leaders know the status of their soldiers' morale, their experience and training, and the strengths and weaknesses of subordinate leaders. They realistically determine all available resources. This includes troops attached to, or in direct support of, the unit. The assessment includes knowing the strength and status of soldiers and their equipment. It also includes understanding the full array of assets in support of the unit. Army leaders know, for example, how much indirect fire, by type, is available and when it will become available. They consider any new limitations based on level of training or recent fighting.

4-31. **Time Available.** Army leaders not only appreciate how much time is available; they understand the time-space aspects of preparing, moving, fighting, and sustaining. They view their own tasks and enemy actions in

relation to time. They know how long it takes under such conditions to prepare for certain tasks (such as, orders production, rehearsals, and subordinate element preparations). Most important, Army leaders monitor the time available. As events occur, they assess their impact on the unit time line and update previous time lines for their subordinates. Time lines list all events that affect the unit and its subordinate elements.

4-32. **Civil Considerations.** *Civil considerations* are how the man-made infrastructure, civilian institutions, and attitudes and activities of the civilian leaders, populations, and organizations within an area of operations influence the conduct of military operations (FM 6-0). Rarely are military operations conducted in uninhabited areas. Most of the time, units are surrounded by noncombatants. These noncombatants include residents of the AO, local officials, and governmental and nongovernmental organizations (NGOs). Based on information from higher headquarters and their own knowledge and judgment, Army leaders identify civil considerations that affect their mission. Civil considerations are analyzed in terms of six factors:

- Areas.
- Structures.
- Capabilities.
- Organizations.
- People.
- Events.

These are known by the memory aid ASCOPE (see FM 6-0).

### Course of Action Development

4-33. Mission analysis provides information needed to develop COAs. The purpose of COA development is simple: to determine one or more ways to accomplish the mission. At lower echelons, the mission may be a single task. Most missions and tasks can be accomplished in more than

one way. However, in a time-constrained environment, Army leaders may develop only one COA. Normally, they develop two or more. Army leaders do not wait for a complete order before beginning COA development. They develop COAs as soon as they have enough information to do so. Usable COAs are suitable, feasible, acceptable, distinguishable, and complete (see Chapter 3). To develop them, leaders focus on the actions the unit takes at the objective and conducts a reverse plan to the starting point.

4-34. **Analyze Relative Combat Power.** During this step, Army leaders determine whether the unit has enough combat power to defeat the force against which it is arrayed by comparing the combat power of friendly and enemy forces. Army leaders seek to determine where, when, and how friendly combat power (the effects of maneuver, firepower, protection, leadership, and information) can overwhelm the enemy. It is a particularly difficult process if the unit is fighting a dissimilar unit (for example, if the unit is attacking or

#### COA Development

1. Analyze relative combat power.
2. Generate options.
3. Array forces.
4. Develop the concept of operations.
5. Assign responsibilities.
6. Prepare COA statement and sketch.



defending against an enemy mechanized force as opposed to a similarly equipped light infantry force). Below battalion level, relative combat power comparisons are very rough and generally rely on professional judgment instead of numerical analysis.

4-35. **Generate Options.** During this step, Army leaders brainstorm different ways to accomplish the mission. They determine the doctrinal requirements for the operation to include the tactical tasks normally assigned to subordinates. Doctrinal requirements give Army leaders a framework from which to develop COAs.

4-36. Next, the leader identifies where and when the unit can mass overwhelming combat power to achieve specific results (with respect to terrain, enemy, or time) that accomplish the mission. They do this by identifying the decisive point or points. The leader determines what is the result that must be achieved at the decisive points to accomplish the mission. This assists the leader in determine the amount of combat power applied at the decisive point and what are the required tasks.

4-37. After identifying the tasks, the leader next determines the purpose for each task. There is normally one primary task for each mission. The unit assigned this task is designated the main effort. The purpose of the other tasks should support the accomplishment of the primary task.

4-38. **Array Forces.** The unit leader then determines what combinations of soldiers, weapons, and other systems should be at each location to accomplish each task. They also assign C2 headquarters for each combination of forces.

4-39. **Develop a Concept of Operations.** The concept of operations describes how the leader envisions the operation unfolding, from its start to its conclusion or end state. They determine how accomplishing each task leads to executing the next. They identify the best ways to use available terrain and how best to employ unit strengths against enemy weaknesses. Fire support considerations make up an important part of the concept of operations. Even if fires are only executed in case of emergency, Army leaders keep in mind the relationship between maneuver and fires. Army leaders develop the graphic control measures necessary to convey and enhance the understanding of the concept of operations, prevent fratricide, and clarify the tasks and purposes of the decisive and shaping operations.

4-40. **Assign Responsibilities.** Army leaders assign responsibility for each task to a subordinate. Whenever possible, they depend on the existing chain of command. They avoid fracturing unit integrity unless the number of simultaneous tasks exceeds the number of available elements. Different command and control arrangements may be the distinguishing feature among COAs.

4-41. **Prepare a COA Statement and Sketch.** Army leaders base the COA statement on the concept of operations for that COA. The COA statement focuses on all significant actions, from the start of the COA to its finish. Whenever possible, Army leaders prepare a sketch showing each COA. Another useful technique is to show the time it takes to achieve each movement and task in the COA sketch. Doing this helps gain an appreciation

for how much time will pass as each task of the COA is executed. The COA contains the following information:

- Form of maneuver or defensive technique to be used.
- Designation of the main effort.
- Tasks and purposes of subordinate units.
- Task and purpose of critical battlefield operating system elements.
- Necessary sustaining operations.
- End state.

4-42. Below is a sample mission statement and course of action for an infantry company in the defense.

- **Mission Statement:** C Co/2-67 IN (L) is prepared NLT 281700(Z) AUG 2005 to destroy enemy forces from GL 375652 to GL 389650 to GL 394660 to GL 373665 to prevent the envelopment of A Co, the battalion main effort.
- **COA Statement:** The company defends with two platoons (PLTs) forward and 1 PLT in depth from PLT battle positions. The northern PLT (2 squads) destroys enemy forces to prevent enemy bypass of the main effort PLT on Hill 657. The southern PLT (3 squads, 2 Javelins) destroys enemy forces to prevent an organized company attack against the Co main effort on Hill 657. The main effort PLT (3 squads, 2 TOWS) retains Hill 657 (vic GL378659) to prevent the envelopment of Co A (BN main effort) from the south. The anti-armor section (1 squad, 4 Javelins) establishes ambush positions at the road junction (vic GL3777653) to destroy enemy vehicles to prevent a concentration of combat power against the main effort PLT. The company mortars locate vic GL 3777664. The antiarmor section initiates fires when the enemy combat reconnaissance patrol reaches the intersection.

### Analyze Courses of Action (War Game)

4-43. For each COA, Army leaders think through the operation from start to finish. They compare each COA with the enemy's most probable COA. At small unit level, the enemy's most probable COA is what the enemy is most likely to do, given what friendly forces are doing at that instant. The leader visualizes a set of actions and reactions. The object is to determine what can go wrong and what decision the leader will likely have to make as a result.

### Compare COAs and Make a Decision

4-44. Army leaders compare COAs by weighing the advantages, disadvantages, strengths, and weaknesses of each, as noted during the wargame. They decide which COA to execute based on this comparison and on their professional judgment. They take into account —

- Mission accomplishment.
- Time to execute the operation.
- Risk.
- Results from unit reconnaissance.
- Subordinate unit tasks and purposes.
- Casualties incurred.
- Posturing the force for future operations.

## **INITIATE MOVEMENT**

4-45. Army leaders initiate any movement necessary to continue mission preparation or position the unit for execution, sometimes before making a tentative plan. They do this as soon as they have enough information to do so, or when the unit is required to move to position itself for a task. This is also essential when time is short. Movements may be to an assembly area, a battle position, a new AO, or an attack position. They may include movement of reconnaissance elements, guides, or quartering parties. Army leaders often initiate movement based on their tentative plan and issue the order to subordinates in the new location.

## **CONDUCT RECONNAISSANCE**

4-46. Whenever time and circumstances allow, Army leaders personally observe the AO for the mission. No amount of intelligence preparation of the battlefield (IPB) can substitute for firsthand assessment of METT-TC from within the AO. Unfortunately, many factors can keep leaders from performing a personal reconnaissance. The minimum action necessary is a thorough map reconnaissance, supplemented by imagery and intelligence products. In some cases, subordinates or other elements (such as scouts) may perform the reconnaissance for the leader while the leader completes other TLP steps.

4-47. Army leaders use the results of the wargame to identify information requirements. Reconnaissance operations seek to confirm or deny information that supports the tentative plan. They focus first on information gaps identified during mission analysis. Army leaders ensure their leader's reconnaissance complements the higher headquarters reconnaissance plan. The unit may conduct additional reconnaissance operations as the situation allows. This step may also precede making a tentative plan if there is not enough information available to begin planning. Reconnaissance may be the only way to develop the information required for planning.

## **COMPLETE THE PLAN**

4-48. During this step, Army leaders incorporate the result of reconnaissance into their selected COA to complete the plan or order. This includes preparing overlays, refining the indirect fire target list, coordinating combat service support and command and control requirements, and updating the tentative plan as a result of the reconnaissance. At lower levels, this step may entail only confirming or updating information contained in the tentative plan. If time allows, Army leaders make final coordination with adjacent units and higher headquarters before issuing the order.

## **ISSUE THE ORDER**

4-49. Small unit orders are normally issued verbally and supplemented by graphics and other control measures. The order follows the standard five-paragraph format OPORD format (see Appendix G). Typically, Army leaders below company level do not issue a commander's intent. They reiterate the intent of their higher and next higher commander.

4-50. The ideal location for issuing the order is a point in the AO with a view of the objective and other aspects of the terrain. The leader may perform a leader's reconnaissance, complete the order, and then summon subordinates

to a specified location to receive it. Sometimes security or other constraints make it infeasible to issue the order on the terrain; then Army leaders use a sand table, detailed sketch, maps, and other products to depict the AO and situation.

## **SUPERVISE AND REFINE**

4-51. Throughout TLP, Army leaders monitor mission preparations, refine the plan, perform coordination with adjacent units, and supervise and assess preparations. Normally unit SOPs state individual responsibilities and the sequence of preparation activities. Army leaders supervise subordinates and inspect their personnel and equipment to ensure the unit is ready for the mission.

4-52. A crucial component of preparation is the rehearsal. Rehearsals allow Army leaders to assess their subordinates' preparations. They may identify areas that require more supervision. Army leaders conduct rehearsals to—

- Practice essential tasks.
- Identify weaknesses or problems in the plan.
- Coordinate subordinate element actions.
- Improve soldier understanding of the concept of operations.
- Foster confidence among soldiers.

4-53. Company and smaller sized units use five types of rehearsals:

- Confirmation brief.
- Backbrief.
- Combined arms rehearsal.
- Support rehearsal.
- Battle drill or SOP rehearsal.

(See FM 6-0 for more information on rehearsals.)

### **Confirmation Brief**

4-54. Immediately after receiving the order, subordinate leaders brief their superior on the order they just received. They brief their understanding of the commander's intent, the specific tasks they have been assigned and their purposes, and the relationship of their tasks to those of other elements conducting the operation. They repeat any important coordinating measures specified in the order. The confirmation brief is normally used with other types of rehearsal.

### **Backbrief**

4-55. The backbrief differs from the confirmation brief in that subordinate leaders are given time to complete their plan. Backbriefs require the fewest resources and are often the only option under time-constrained conditions. Subordinate leaders explain their actions from start to finish of the mission. Backbriefs are performed sequentially, with all leaders going over their tasks. When time is available, backbriefs can be combined with other types of rehearsals. Doing this lets all element leaders coordinate their plans before performing more elaborate drills. If possible, backbriefs are performed overlooking subordinates' AOs, after they have developed their own plans.

### Combined Arms Rehearsal

4-56. A combined arms rehearsal requires considerable resources, but provides the most planning and training benefit. Depending on circumstances, units may conduct a reduced force or full dress rehearsal.

4-57. **Reduced Force.** Circumstances may prohibit a rehearsal with all members of the unit. Unit leaders and other key individuals may perform a reduced force rehearsal, while most of their subordinates continue to prepare for the operation. Often, smaller scale replicas of terrain or buildings substitute for the actual AO. Army leaders not only explain their plans, but also walk through their actions or move replicas across the rehearsal area or sand table. This is called a “rock drill.” It reinforces the backbrief given by subordinates, since everyone can see the concept of operations and sequence of tasks.

4-58. **Full Dress.** The preferred rehearsal technique is a full dress rehearsal. Army leaders rehearse their subordinates on terrain similar to the AO, initially under good light conditions, and then in limited visibility. Small unit actions are repeated until executed to standard. Full dress rehearsals help soldiers to clearly understand what is expected of them. It helps them gain confidence in their ability to accomplish the mission. Supporting elements, such as aviation crews, meet soldiers and rehearse with them. An important benefit is the opportunity to synchronize the operation. The unit may conduct full dress rehearsals. They also may be conducted and supported by the higher headquarters.

### Support Rehearsals

4-59. At any point in TLP, units may rehearse their support for an operation. For small units, this typically involves coordination and procedure drills for aviation, fire, combat service, engineer support, or casualty evacuation. Support rehearsals and combined arms rehearsals complement preparations for the operation. They may be conducted separately and then combined into full dress rehearsals.

### Battle Drills or SOP Rehearsal

4-60. A battle drill is a collective action rapidly executed without applying a deliberate decision making process. A battle drill or SOP rehearsal ensures that all participants understand a technique or a specific set of procedures. Throughout preparation, units rehearse battle drills and SOP actions. These rehearsals do not need a completed order from higher headquarters. Army leaders place priority on those drills or actions they anticipate occurring during the operation. For example, a transportation platoon may rehearse a battle drill on reacting to an ambush while awaiting the movement order.

4-61. Army leaders refine their plan based on continuing analysis of their mission and updated intelligence. Most important, Army leaders know that they create plans to ensure all their subordinates focus on accomplishing the same mission within the commander’s intent. If required, they can deviate from the plan and execute changes based on battlefield conditions and the enemy. Army leaders oversee preparations for operations. These include inspections, coordination, reorganization, fire support and engineer activities, maintenance, resupply, and movement. The requirement to supervise is con-

tinuous; it is as important as issuing orders. Supervision allows Army leaders to assess their subordinates' understanding of their orders and determine where additional guidance is needed. It is crucial to effective preparation.

## Appendix A

### Staff Studies and Decision Papers

Staff studies and decision papers are means to present recommendations for solving problems. Both are complete, coordinated staff actions that include the documents needed to implement their recommendations. This appendix discusses how to prepare them. It includes formats for both. The staff study and decision paper formats parallel the Army problem solving steps discussed in Chapter 2.

#### STAFF STUDIES

A-1. A staff study is a formal report of the methodology and information used to solve a problem or answer a question. It requests the decision maker to act on its recommendation and provides the required implementing documents for signature. It is coordinated with all affected organizations and includes any statements of nonconcurrence and the corresponding considerations of nonconcurrence. A staff study is comprehensive: it includes all relevant information gathered while solving the problem and a complete description of the methodology used to arrive at the recommended solution.

A-2. The body of a completed staff study is a stand-alone document. While annexes are a part of most staff studies, readers should not need to refer to them to understand the recommendation and the basis for it. Annexes contain details and supporting information. They are used to keep the body of the study concise.

#### THE STAFF STUDY FORMAT

A-3. Prepare staff studies as informal memorandums (see AR 25-50) in the format at Figure A-1. This format parallels the steps of Army problem solving in Chapter 2. Commands and other agencies often establish format standards to meet local requirements.

#### Memorandum For

A-4. Address the staff study to the decision maker. Include thru addressees here or on the routing slip, as specified by command policy.

CONTENTS	
Staff Studies .....	A-1
The Staff Study Format.....	A-1
Coordinating Staff Studies .....	A-6
Common Problems of Staff Studies .....	A-7
Decision Papers .....	A-7

Office Symbol (Marks Number)

Date

**MEMORANDUM FOR**

**SUBJECT:**

- 1. **PROBLEM.**
- 2. **RECOMMENDATION.**
- 3. **BACKGROUND.**
- 4. **FACTS.**
- 5. **ASSUMPTIONS.**
- 6. **COURSES OF ACTION.**
- 7. **CRITERIA.**
  - a. **Screening Criteria.**
  - b. **Evaluation Criteria.**
  - c. **Weighting of Criteria.**
- 8. **ANALYSIS.**
  - a. **COAs Screened Out.**
  - b. **COA 1.**
    - (1) **Advantages.**
    - (2) **Disadvantages.**
  - c. **COA 2.** (Use the same sub-subparagraphs as COA 1.)
- 9. **COMPARISON.**
- 10. **CONCLUSION.**
- 11. **COORDINATION.**

ACofS, G1            CONCUR/NONCONCUR \_\_\_\_\_ CMT \_\_\_\_\_ DATE: \_\_\_\_\_

DPTM                CONCUR/NONCONCUR \_\_\_\_\_ CMT \_\_\_\_\_ DATE: \_\_\_\_\_

**12. APPROVAL/DISAPPROVAL.**

a. That the (state the approving authority and recommended solution).

**APPROVED** \_\_\_\_\_ **DISAPPROVED** \_\_\_\_\_ **SEE ME** \_\_\_\_\_

b. That the (approving authority) sign the implementing directive(s) (TAB A).

**APPROVED** \_\_\_\_\_ **DISAPPROVED** \_\_\_\_\_ **SEE ME** \_\_\_\_\_

**13. POINT OF CONTACT.**

[#] Encl

[Signature Block]

- 1. Implementing document
- 2. Tasking document
- 3. Coordination list
- 4. Nonconcurrences
- 5. Other supporting documents, listed as separate annexes

**Figure A-1. Format for a Staff Study**



**Subject**

A-5. Briefly state the study's subject. Be specific. "Staff Study" is not an acceptable subject.

**Problem**

A-6. In paragraph 1, concisely state the problem as an infinitive phrase or question; for example, To determine..., or, How to.... Include the who, what, when, and where, if pertinent.

**Recommendation**

A-7. In paragraph 2, recommend a solution or solutions based on the conclusion in paragraph 10. If there are several recommendations, state each one in a separate subparagraph.

**Background**

A-8. In paragraph 3, briefly state why the problem exists. Provide enough information to place the problem in context. This discussion may include the origin of the action and a summary of events related to it. If a tasking document accompanies the staff study, place it in enclosure 2 and refer to it here.

**Facts**

A-9. In paragraph 4, state all facts that influence the problem or its solution. List each fact as a separate subparagraph. Make sure the facts are stated and attributed correctly. Facts must stand-alone: either something is clearly a fact or it is attributed to a source that asserts it to be true. There is no limit to the number of facts. Provide all facts relevant to the problem, not just facts used to support the study. State any guidance given by the decision maker. Refer to annexes as necessary for amplification, references, mathematical formulas, or tabular data.

**Assumptions**

A-10. In paragraph 5, identify assumptions necessary for a logical discussion of the problem. List each assumption as a separate subparagraph.

**Possible Solutions**

A-11. In paragraph 6, list all solutions considered. Place each solution in a separate subparagraph. List each solution by number and name, or as a short sentence in the imperative mode (for example, Increase physical security measures at key assets). If a solution is not self-explanatory, include a brief description of it. Use enclosures to describe complex solutions.

**Criteria**

A-12. In paragraph 7, list and define, in separate subparagraphs, the screening and evaluation criteria. There should be a fact or an assumption in paragraph 4 or 5 that supports each criterion. The number of facts and

assumptions should, at a minimum, be greater than the number of criteria. In a third subparagraph, explain the rationale for how the evaluation criteria are weighted.

A-13. **Screening Criteria.** In subparagraph 7a, list the screening criteria, each in its own sub-subparagraph. Screening criteria define the minimum and maximum characteristics of the solution to the problem. Define each screening criterion in terms of the five characteristics in Chapter 2: suitability, feasibility, acceptability, distinguishability, and completeness. Screening criteria are not weighted. They are required, absolute standards. COAs that do not meet them are rejected.

A-14. **Evaluation Criteria.** In subparagraph 7b, list the evaluation criteria, each in its own sub-subparagraph. List them in order of their weight, from most to least important. Define each evaluation criterion in terms of the five required elements listed in Chapter 2: short title, definition, unit of measure, benchmark, and formula.

A-15. **Weighting of Criteria.** In subparagraph 7c, state the relative importance of each evaluation criterion with respect to the others. Explain how each criterion compares to each of the other criteria (equal, favored, slightly favored, strongly favored), or provide the values from the decision matrix and explain why the criterion is measured as such. This subparagraph explains the order in which the evaluation criteria are listed in subparagraph 7b.

## Analysis

A-16. Paragraph 8 lists the solutions that do not meet the screening criteria and the results of applying the evaluation criteria to the remaining ones.

A-17. **Solutions Screened Out.** In subparagraph 8a, list the solution that did not meet the screening criteria, each in its own subparagraph, and the criteria each did not meet. This subparagraph is particularly important if a solution the decision maker wanted considered does not meet the screening criteria.

A-18. **Evaluated Solutions.** In subsequent subparagraphs, list the solutions evaluated, each in its own subparagraph. Discuss the advantages and disadvantages of each solution in sub-subparagraphs. For quantitative criteria, include the payoff value. Advantages and disadvantages may be discussed in narratives or listed. Use the form that best fits the information. Avoid using bullets unless the advantage or disadvantage is self-evident.

## Comparison

A-19. In paragraph 9, compare the solutions to each other, based on the analysis outlined in paragraph 8. Develop in a logical, orderly manner the rationale used to reach the conclusion in paragraph 10. If quantitative techniques are used in the comparison, summarize the results clearly enough that the reader does not have to refer to an enclosure. Include any explanations of quantitative techniques in enclosures. State only the results in paragraph 9.

## Conclusion

A-20. In paragraph 10, state the conclusion drawn based on the analysis (paragraph 8) and comparison (paragraph 9). The conclusion must answer the question or solve the problem. It must match the recommendation in paragraph 2.

## Coordination

A-21. In paragraph 11, list all organizations with which the study was coordinated (“staffed”) in the format shown in Figure A-1. If the list is very long, or if space is a consideration, place this list in enclosure 3. If the staffing list is placed in enclosure 3, indicate the number of nonconcurrences with the cross-reference (for example, See enclosure 3; 2 nonconcurrences; or, See enclosure 3; no nonconcurrences).

A-22. A representative of each organization with which the study was staffed indicates whether the organization concurs with the study, nonconcurr, or concurs with comment. Representatives place their initials in the blank, followed by their rank, name, position, telephone number, and e-mail address. If separate copies were sent to each organization (rather than sending one copy to each organization in turn), this information may be typed into the final copy of the study and the actual replies placed in enclosure 4. This convention is recommended when using e-mail for staffing.

A-23. Place all statements of nonconcurrence and considerations of nonconcurrence in enclosure 3, or in separate enclosures for each nonconcurrence. Concurrences with comment may be placed in enclosure 3 or in a separate enclosure or enclosures

## Approval Line

A-24. In paragraph 12, restate the recommendation from paragraph 2 and provide a format for the approval authority to approve or disapprove the recommendation.

## Point of Contact

A-25. Use paragraph 13 to record the point of contact or action officer, and contact information. As a minimum, contact information includes a military telephone number. Additional contact information may include the action officer’s organization, a civilian telephone number, a unit address, and an e-mail address.

## Signature Block

A-26. Prepare the signature block as specified in AR 25-50.

## Enclosures

A-27. The first four enclosures are standard for all staff studies:

- Enclosure 1 contains implementing memorandums, directives, or letters submitted for signature or approval. A staff study requests a decision. Enclosure 1 contains the documents required to implement the decision the staff study recommends.

- Enclosure 2 contains the document that directed the staff study. If the requirement was given verbally, include the memorandum for record that documents the conversation. If no record exists, enter “Not used” in the annex list in the body.
- Enclosure 3 contains the staffing list, if the list is too long for paragraph 11. If paragraph 11 contains the entire staffing list, enter “Not used” in the enclosure list in the body.
- Enclosure 4 contains statements of nonconcurrency and considerations of nonconcurrency. Statements of nonconcurrency and their corresponding considerations of nonconcurrency may be placed in separate enclosures. Concurrences with comment may be placed in either Enclosure 4 or a separate enclosure(s). If there are no statements of nonconcurrency, enter “Not used” in the enclosure list in the body.

A-28. Other enclosures contain detailed data, lengthy discussions, and bibliographies. Number the pages of each enclosure separately, except when an enclosure contains several distinct documents (such as, concurrences). Enclosures are usually tabbed (see Figure A-3).

## **COORDINATING STAFF STUDIES**

A-29. Preparing a staff study normally involves coordinating with other staff officers and organizations. At minimum, action officers obtain concurrences or nonconcurrences from agencies affected by the study’s recommendations. Other aspects of the study may require coordination as well. Coordination should be as broad as time permits, but should be limited to agencies that might be affected by possible recommendations or that have expertise in the subject of the study.

A-30. Action officers anticipate nonconcurrences and try to resolve as many as possible before staffing the final product. An action officer who cannot resolve a nonconcurrency has two options:

- Modify the staff study to satisfy the nonconcurrency, if the analysis and comparison support the change. If this is done after the final draft has been staffed, the study must be restaffed.
- Prepare a consideration of nonconcurrency and include it and the statement of nonconcurrency in Annex C to the staff study as discussed in paragraph A-23.

### **Statements of Nonconcurrency**

A-31. A statement of nonconcurrency is a recommendation that the decision maker reject all or part of the staff study. Statements of nonconcurrency are prepared in the memorandum format; e-mail may be accepted at the commander’s discretion. They address specific points in the recommendations or the study, stating why they are wrong or unacceptable. When possible they offer an alternative or a constructive recommendation.

### **Considerations of Nonconcurrency**

A-32. Prepare considerations of nonconcurrency as a memorandum for record. Present the reasons for the nonconcurrency accurately and assess them

objectively. Then state why the study is correct and why the decision maker should reject the nonconcurrency.

## COMMON PROBLEMS WITH STAFF STUDIES

A-33. The following questions identify the most common problems found in staff studies. Review them before beginning a staff study and periodically thereafter:

- Is the subject too broad?
- Is the problem properly defined?
- Are facts or assumptions clear and valid?
- Are there any unnecessary facts or assumptions?
- Are there any facts that appear for the first time in the discussion?
- Are there a limited number of options or COAs?
- Are evaluation criteria invalid or too limiting?
- Is the discussion too long?
- Is the discussion incomplete? Must readers consult the enclosures to understand it?
- Does the conclusion include a discussion?
- Is the logic incorrect or incomplete? Does the conclusion follow from the analysis?
- Can the solution be implemented within resource and time constraints?
- Do the conclusions and recommendations solve the problem?
- Is there an implementing directive?
- Have new criteria been introduced in the analysis or comparison?

## DECISION PAPERS

A-34. A decision paper is a piece of correspondence that requests the decision maker to act on its recommendation and provides the required implementing documents for signature. Use a decision paper when a formal report is not necessary or the decision maker does not require the details a staff study provides.

A-35. Decision papers are brief. Unlike staff studies, decision papers are not self-contained. For a decision paper, much of the material that would be included in a staff study is kept in the action officer's file. Decision papers contain the minimum information the decision maker needs to understand the action and make a decision. The action officer synthesizes the facts, summarizes the issues, presents feasible alternatives, and recommends one of them. Essential explanations and other information are attached as enclosures, which are always tabbed (see Figure A-3).

A-36. Prepare decision papers as informal memorandums (see AR 25-50) in the format at Figure A-2. This format parallels the steps of Army problem solving. Commands and other agencies often establish format standards to meet local requirements. Decision papers should not exceed two pages, excluding the staffing list and supporting documentation. The coordination

requirements for a decision paper are the same as those for a staff study. Follow the procedures in paragraphs A-29 through A-32.

Office Symbol (Marks Number)	Date
<b>MEMORANDUM FOR</b>	
<b>SUBJECT:</b>	
1. For <b>DECISION</b> .	
2. <b>PURPOSE</b> .	
3. <b>RECOMMENDATION</b> .	
4. <b>BACKGROUND AND DISCUSSION</b> .	
5. <b>IMPACTS</b> .	
6. <b>COORDINATION</b> .	
A CofS, G1	CONCUR/NONCONCUR _____ CMT _____ DATE: _____
DPTM	CONCUR/NONCONCUR _____ CMT _____ DATE: _____
7. <b>APPROVAL/ DISAPPROVAL</b> .	
a. That the (state the approving authority and recommended solution).	
APPROVED _____ DISAPPROVED _____ SEE ME _____	
b. That the (approving authority) sign the implementing directive(s) (TAB A).	
APPROVED _____ DISAPPROVED _____ SEE ME _____	
8. <b>POINT OF CONTACT</b> .	
[#] Encls	(Signature Block)
1. Implementing document (TAB A)	
2. Tasking document (TAB B)	
3. Coordination list (TAB C)	
4. Nonconcurrences (TAB D)	
5-[#]. Other supporting documents, listed as separate enclosures (TABS E through Z)	

**Figure A-2. Format for a Decision Paper**

**MEMORANDUM FOR**

A-37. Address the decision paper to the decision maker. Include thru addressees here or on the routing slip, as specified by command policy.

**SUBJECT**

A-38. Briefly state the decision’s subject. Be specific. “Decision Paper” is not an acceptable subject.

**FOR DECISION**

A-39. Paragraph 1 states, “For DECISION.” (Paragraph headings may be either underlined or bolded, according to command policy.) Indicate if the

decision is time-sensitive, tied to an event, or has a suspense to a higher headquarters. Show internal suspenses on the routing slip, if necessary. Do not show them in this paragraph.

## **PURPOSE**

A-40. In paragraph 2, state clearly the decision required, as an infinitive phrase; for example, "To determine the..." or, "To obtain...." Include the who, what, when, and where, if pertinent.

## **RECOMMENDATION**

A-41. In paragraph 3, recommend a solution or solutions to the problem. If there are several recommendations, state each one in a separate subparagraph.

## **BACKGROUND AND DISCUSSION**

A-42. Paragraph 4 explains the origin of the action, why the problem exists, and a summary of events in chronological form. It helps put the problem in perspective and provide an understanding of the alternatives and the recommendation. If the decision paper is the result of a tasking document, refer to that document here, and place it at enclosure 2.

## **IMPACT**

A-43. Paragraph 5 states the impacts of the recommended decision. Address each affected area in a separate subparagraph; for example, personnel, equipment, funding, environment, and stationing. State who is affected by the recommendation and the extent to which they are affected.

## **COORDINATION**

A-44. In paragraph 6, list all organizations with which the decision paper was staffed in the format shown in Figure A-2. If the list is very long, or if space is a consideration, place this list in enclosure 3. If the staffing list is placed in enclosure 3, indicate the number of nonconcurrences with the cross-reference (for example, See enclosure 3; 2 nonconcurrences; or, See enclosure 3; no nonconcurrences).

A-45. A representative of each organization with which the decision paper was staffed indicates whether the organization concurs, nonconcurr, or concurs with comment. Representatives place their initials in the blank, followed by their rank, name, position, telephone number, and e-mail address. If separate copies were sent to each organization (rather than sending one copy to each organization in turn), this information may be typed into the final copy of the decision paper and the actual replies placed in enclosure 3. This convention is recommended when using e-mail for staffing.

A-46. Place all statements of nonconcurrence and considerations of nonconcurrence in enclosure 4, or in separate enclosures for each nonconcurrence. Prepare them as specified in paragraphs A-31 and A-32. Concurrences with comment may be placed in enclosure 4 or in a separate annex or annexes.

## APPROVAL LINE

A-47. In paragraph 7, restate the recommendations from paragraph 2 and provide a format for the approval authority to approve or disapprove the recommendation.

## POINT OF CONTACT

A-48. Use paragraph 8 to record the point of contact or action officer, and contact information. As a minimum, contact information includes a military telephone number. Additional contact information may include the action officer's organization, a civilian telephone number, a unit address, and an e-mail address.

## SIGNATURE BLOCK

A-49. Prepare the signature block as specified in AR 25-50.

## ENCLOSURES

A-50. The first four enclosures are standard for all decision papers:

- Enclosure 1 contains implementing memorandums, directives, or letters submitted for signature or approval.
- Enclosure 2 contains the document that directed the decision paper. If the requirement was given verbally, include the memorandum for record that documents the conversation. If no record exists, enter "Not used" in the enclosure list.
- Enclosure 3 contains the staffing list, if the list is too long for paragraph 6. If paragraph 6 contains the entire staffing list, enter "Not used" in the enclosure list.
- Enclosure 4 contains statements of nonconcurrency and considerations of nonconcurrency. Statements of nonconcurrency and their corresponding considerations of nonconcurrency may be placed in separate enclosures. Concurrences with comment may be placed in either enclosure 4 or a separate enclosure or enclosures. If there are no statements of nonconcurrency, enter "Not used" in the enclosure list.

A-51. Other enclosures contain detailed data, lengthy discussions, and bibliographies. Number the pages of each enclosure separately, except when an enclosure contains several distinct documents (such as, concurrences). Use the convention in Appendix G to assign enclosure page numbers.



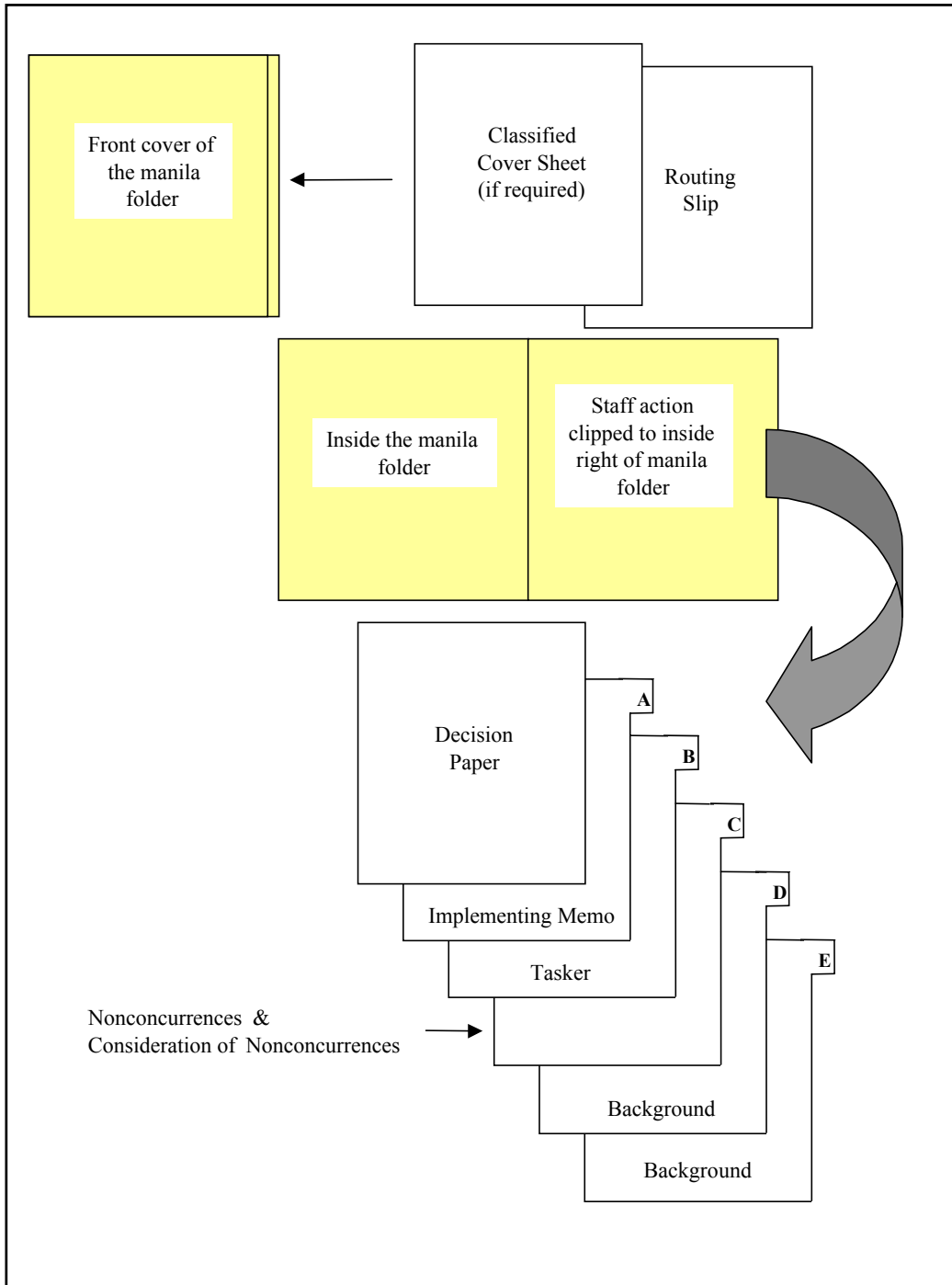

Figure A-3. Assembling and Tabbing Staff Actions



## Appendix B

# Military Briefings

Briefings are a means of presenting information to commanders, staffs, or other audiences. The purpose of the briefing, the desired response, and the role of the briefer determine the techniques employed. This appendix describes the types of military briefings and gives a format for each type.

### TYPES OF BRIEFINGS

B-1. There are four types of military briefings:

- Information.
- Decision.
- Mission.
- Staff.

### INFORMATION

B-2. An information briefing provides information in a form the audience can understand. It does not include conclusions or recommendations. No decisions result. Information briefings deal primarily with facts. Figure B-1 shows the format for an information briefing.

B-3. The briefer begins an information briefing by addressing the audience, identifying themselves and the organization, and gives the classification of the briefing. The briefer states that the purpose of the briefing is for information and no decision is required. The briefer then introduces and defines the subject, orients the audience, and presents the information. Examples of information appropriate for an information briefing are—

- High priority information requiring immediate attention.
- Complex information—such as, complicated plans, systems, statistics, or charts—that require detailed explanation.
- Controversial information requiring elaboration and explanation.

CONTENTS	
Types of Briefings .....	B-1
Information .....	B-1
Decision .....	B-2
Mission .....	B-3
Staff .....	B-4
Briefing Steps .....	B-4
Analyze Situation and Prepare a	
Briefing Outline .....	B-4
Construct Briefing .....	B-5
Deliver Briefing .....	B-5
Follow Up .....	B-6

## DECISION

B-4. A decision briefing obtains an answer to a question or a decision on a course of action. It presents the recommended solution resulting from analysis or study of a problem or problem area. Decision briefings vary in formality and detail depending on the level of command and the decision makers' knowledge of the subject.

- 1. Introduction**
  - a. Greeting.** Address the audience. Identify yourself and your organization.
  - b. Type and Classification of Briefing.** For example, "This is an information briefing. It is classified SECRET."
  - c. Purpose and Scope.** Describe complex subjects from general to specific.
  - d. Outline or Procedure.** Briefly summarize the key points and general approach. Explain any special procedures (such as, demonstrations, displays, or tours). For example, "During my briefing, I'll discuss the six phases of our plan. I'll refer to maps of our area of operations. Then my assistant will bring out a sand table to show you the expected flow of battle." The key points may be placed on a chart that remains visible throughout the briefing.
- 2. Main Body**
  - a. Arrange the main ideas in a logical sequence.
  - b. Use visual aids to emphasize main ideas.
  - c. Plan effective transitions from one main point to the next.
  - d. Be prepared to answer questions at any time.
- 3. Closing**
  - a. Ask for questions.
  - b. Briefly recap main ideas and make a concluding statement.
  - c. Announce the next speaker.

### Figure B-1. Information Briefing Format

B-5. In situations where the decision maker is familiar with the problem, the briefing format may resemble that of a decision paper: a problem statement, essential background information, impacts, and a recommended solution. However, briefers are prepared to present assumptions, facts, alternative solutions, reasons for adopting the recommendation, and the coordination involved.

B-6. If the decision maker is unfamiliar with the problem, the briefing format resembles that of a decision briefing (see Figure B-2). The briefing should include facts bearing on the problem, assumptions, and a discussion of alternatives, conclusions, and the coordination involved.

B-7. The briefer begins by stating, "This is a decision briefing." At the conclusion, if the decision maker does not state a decision, the briefer asks for one. The

briefers should be certain that he understands the decision. If uncertain, the briefers ask for clarification.

B-8. The recommendation the briefers ask the decision maker to approve should be precisely worded in a form that can be used as a decision statement. Presenting the recommendation this way helps eliminate ambiguities. If the decision requires an implementing document, it should be prepared before the briefing and given to the decision maker for signature if the recommendation is approved. If the chief of staff (executive officer) is not present, the briefers inform the secretary of the general staff or other appropriate authority of the decision after the briefing.

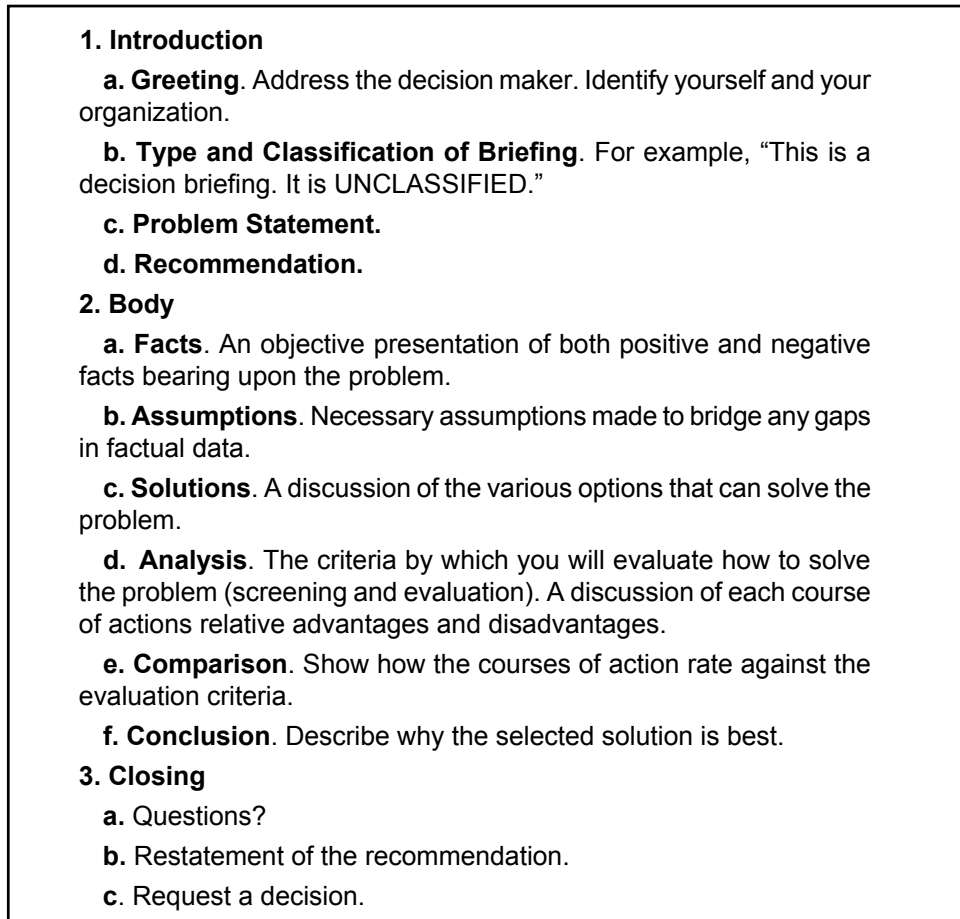

Figure B-2. Decision Briefing Format

**MISSION**

B-9. The mission briefing is an information briefing presented under tactical or operational conditions. The briefers may be the commander, an assistant, a staff officer, or a special representative.

B-10. The mission briefing is used during operations and training. It is especially appropriate for critical missions or when it is necessary to give individuals or

smaller units information not in the plan or order. The mission briefing serves to—

- Issue or reinforce an order.
- Provide more detailed requirements or instructions.
- Instill a general appreciation for the mission.
- Review the key points of a forthcoming military operation.
- Ensure participants know the mission's objective, their place in the operation, problems they may confront, and ways to overcome them.

B-11. The type of mission or the nature of the information to be presented determines the mission briefing format. The five-paragraph operation order is the most common format used. Others include the movement order, combat service support order, and reconnaissance order.

## STAFF

B-12. The purpose of a staff briefing is to coordinate unit efforts by informing the commander and staff of the current situation. The person who convenes the staff briefing sets the agenda. Staff representatives each present relevant information from their functional areas. Staff briefings may involve exchange of information, announcement of decisions, issuance of directives, or presentation of guidance. They may have characteristics of information briefings, decision briefings, and mission briefings.

B-13. Attendance at staff briefings varies with the size of the headquarters, type of operation, and commander's preferences. Generally, the commander, deputies or assistants, chief of staff (executive officer), and coordinating and special staff officers attend. Representatives from major subordinate commands may be present. The chief of staff (executive officer) usually presides. The commander usually concludes the briefing but may take an active part throughout it.

B-14. In garrison, staff briefings (sometimes called "staff calls") are often regularly scheduled. In combat, staff briefings are held as needed. The presentation of staff estimates culminating in a commander's decision to adopt a course of action is a form of staff briefing that incorporates aspects of a decision briefing. In this type of briefing, staff representatives use the staff estimate for their functional area as an outline.

## BRIEFING STEPS

B-15. A briefing assignment has four steps that correspond to the four activities of the operations process:

- Plan: Analyze the situation and prepare a briefing outline.
- Prepare: Construct the briefing.
- Execute: Deliver the briefing.
- Assess: Follow up.

## ANALYZE SITUATION AND PREPARE A BRIEFING OUTLINE

B-16. Upon receiving the task to conduct a briefing, the briefer analyzes the situation to determine the—

- Audience.

- Purpose and type of briefing.
- Subject of the briefing.
- Physical facilities and support needed.
- Preparation schedule.

B-17. Based on this information, the briefer prepares a briefing outline. The briefing outline is the briefer's plan for preparing, executing, and following up on the briefing. It is a tool the briefer uses to manage preparations for the briefing and refines as new information is received.

B-18. Figure B-3 lists factors the briefer considers when planning a briefing and tasks performed, by the briefer, to prepare for it. In addition to those, briefers determine the following:

- Audience preferences—for a decision briefing, those of the decision maker.
- The purpose of the briefing—the purpose determines the type of briefing.
- The time allocated for the briefing—this dictates the style, physical facilities, and the preparatory effort needed.
- The availability of physical facilities, visual aids, and visual information specialists.

The briefer estimates deadlines for each task and carefully schedules the preparatory effort. This includes scheduling facilities for rehearsals and requesting critiques. The briefer alerts support personnel and any assistants as early as possible.

## CONSTRUCT BRIEFING

B-19. The construction of the briefing will vary with its type and purpose. The analysis provides the basis for this determination. The following are the major steps in preparing a briefing:

- Collect material.
- Prepare first draft.
- Revise first draft and edit.
- Plan use of visual aids.
- Practice.

Figure B-3, page B-7, lists components of these steps and factors to consider.

## DELIVER BRIEFING

B-20. The success of a briefing often depends on how well it is presented. A confident, relaxed, and forceful delivery, clearly enunciated, helps convince the audience. Briefers maintain a relaxed, but military bearing. They use natural gestures and movement, but avoid distracting mannerisms. Conciseness, objectivity, and accuracy characterize good delivery. The briefer remains aware of the following:

- The basic purpose is to present the subject as directed and ensure that the audience understands it.
- Brevity precludes a lengthy introduction or summary.
- Conclusions and recommendations must flow logically from facts and assumptions.

B-21. Interruptions and questions may occur at any point. If and when they occur, briefers answer each question before continuing, or indicate that the question will be answered later in the briefing. At the same time, they do not permit questions to distract them from the planned briefing. If the question will be answered later in the briefing, briefers make specific reference to the earlier question when they introduce the material. Briefers are prepared to support any part of the briefing. They anticipate possible questions and are prepared to answer them.

## **FOLLOW UP**

B-22. When the briefing is over, the briefer prepares a memorandum for record (MFR). This MFR records the subject, date, time, and place of the briefing, and the ranks, names, and positions of audience members. The briefing's substance is concisely recorded. Recommendations and their approval, disapproval, or approval with modification are recorded, as well as any instruction or directed action. This includes who is to take action. When a decision is involved and doubt exists about the decision maker's intent, the briefer submits a draft of the MFR to him for correction before preparing it in final form. The MFR is distributed to staff sections and agencies required to act on the decisions or instructions, or whose operations or plans may be affected.



**1. Analyze Situation and Prepare a Briefing Outline.**

**a. Audience.**

- Number?
- Composition? Single service or joint? Civilians? Foreign nationals?
- Who are the ranking members?
- What are their official positions?
- Where are they assigned?
- How well do they know the subject?
- Are they generalists or specialists?
- What are their interests?
- What are their personal preferences?
- What is the anticipated reaction?

**b. Purpose and Type.**

- Information briefing (to inform)?
- Decision briefing (to obtain decision)?
- Mission briefing (to review important details)?
- Staff briefing (to exchange information)?

**c. Subject of Briefing.**

- What is the specific subject?
- What is the desired coverage?
- How much time will be allocated?

**d. Physical Facilities and Support Needed.**

- Where will the briefing be presented?
- What arrangements will be required?
- What are the visual aid facilities?
- What are the deficiencies?
- What actions are needed to overcome deficiencies?

**e. Prepare Schedule.**

- Finish analysis of the situation.
- Prepare preliminary outline.
- Determine requirements for training aids, assistants, and recorders.
- Edit or redraft.
- Schedule rehearsals, facilities, and critiques.
- Arrange for final review by responsible authority.

**2. Construct briefing**

**a. Collect Material.**

- Research.
- Become familiar with the subject.
- Collect authoritative opinions and facts.

**b. Prepare First Draft.**

- State problem (if necessary).
- Isolate key points (facts).
- Identify courses of action.
- Analyze and compare courses of action. (State advantages and disadvantages.)
- Determine conclusions and recommendations.
- Prepare draft outline.
- Include visual aids.
- Fill in appropriate material.
- Review with appropriate authority.

**c. Revise First Draft and Edit.**

- Make sure that facts are important and necessary.
- Include all necessary facts.
- Include answers to anticipated questions.
- Polish material.

**d. Plan Use of Visual Aids.**

- Check for simplicity and readability.
- Develop method for use.

**e. Practice.**

- Rehearse (with assistants and visual aids).
- Polish.
- Isolate key points.
- Memorize outline.
- Develop transitions.
- Use definitive words.

**3. Deliver Briefing.**

**4. Follow-up.**

- a.** Ensure understanding.
- b.** Record decision.
- c.** Inform proper authorities.

Figure B-3. Briefing Checklist



## Appendix C

### Staff Guidelines for Mission Analysis

This appendix provides factors for staff members to consider when conducting mission analysis. It expands on the mission analysis section discussed in Chapter 3. The factors for consideration are not all-inclusive. They are generic and should be reviewed and revised to meet individual needs. Staff members not listed in this appendix should review FM 6-0 for a listing of all coordinating, personal, and special staff officers with their corresponding duties and responsibilities.

C-1. A thorough mission analysis is crucial to planning. Both the process and products of mission analysis help the commander and staff develop and refine their situational understanding. By having a thorough understanding of the factors of mission, enemy, terrain and weather, troops and support available, time available, and civil considerations (METT-TC), the commander and staff can develop effective courses of action to accomplish the mission.

C-2. Commanders and staffs thoroughly analyze the higher headquarters order to establish where the unit mission fits into the missions of higher and adjacent units. Their goal is to determine how their unit, by task and purpose, contributes to the mission, commander's intent, and concept of operations of the higher headquarters. They also analyze their own unit's capabilities and limitations, those of the enemy, and evaluate the terrain in which they will operate. The following paragraphs list factors staff members consider when preparing for the mission analysis briefing. Staff members bring to the mission analysis briefing technical knowledge, estimates, and historical data to assist the commander in understanding the situation and unit's mission.

#### ALL STAFF OFFICERS

C-3. All staff officers consider—

- Mission and intent of higher headquarters one and two levels up.
- Specified, implied, and essential tasks.
- Area of operations.
- Area of interest.
- Enemy situation and capabilities.
- Critical facts and assumptions.
- Status of subordinate units.
- Weapon systems capabilities and limitations.
- Status of available assets within their functional area or battlefield operating system.
- Constraints.

- Risk considerations.
- Time considerations.
- Recommended commander's critical information requirements (CCIR) and information requirements (IR).
- Recommended intelligence, surveillance, and reconnaissance (ISR) tasks.

### **ASSISTANT CHIEF OF STAFF, G-1/AG (S-1), PERSONNEL**

C-4. The assistant chief of staff (ACOS), G-1/AG (S-1), conducts mission analysis on all matters concerning human resources support (military and civilian). They consider factors relating to manning, personnel services, and personnel support. Specific responsibilities include—

- Analyzing personnel strength data to determine current capabilities and project future requirements.
- Analyzing unit strength maintenance, including monitoring, collecting, and analyzing data affecting soldier readiness.
- Preparing estimates for personnel replacement requirements, based on estimated casualties, non-battle losses, and foreseeable administrative losses to include critical military occupational skill (MOS) requirements.
- Determining personnel services available to the force (current and projected).
- Determining personal support available to the force (current and projected).

### **ASSISTANT CHIEF OF STAFF, G-2 (S-2), INTELLIGENCE**

C-5. The ACOS, G-2 (S-2) conducts mission analysis on all matters concerning the enemy/threat, the environment as it affects the enemy/threat, intelligence, and counterintelligence. Specific responsibilities include—

- Managing intelligence preparation of the battlefield (IPB), to include integrating the IPB efforts of the rest of the staff and other echelons, and supporting parallel planning during dynamic situations.
  - Define the battlefield environment.
  - Define the battlefield effects.
  - Evaluate the threat
  - Determine threat COAs.
- Performing situation development, to include updating the enemy/threat, terrain and weather, and civil consideration portions of the common operational picture.
- Developing and continuously updating a list of intelligence gaps.
- Recommending CCIR, priority intelligence requirements (PIR) and friendly forces information requirements (FFIR), and IR to develop initial collection tasks and requests for support from higher and adjacent commands.
- Determining collection capabilities and limitations.
- Determine unit intelligence production capabilities and limitations.

- Facilitating ISR integration by giving the commander and G-3 (S-3) the initial ISR synchronization plan and helping the G-3 (S-3) develop the initial ISR plan.
- Identifying enemy intelligence collection capabilities, such as efforts targeted against the unit.

### **ASSISTANT CHIEF OF STAFF, G-3 (S-3), OPERATIONS**

C-6. The ACOS, G-3 (S-3) conducts mission analysis on all matters concerning training, operations, and plans. Specific responsibilities include—

- Managing the overall mission analysis effort of the staff to include—
  - Consolidating facts and assumptions, specific and implied tasks, constraints, risk considerations, unit status, and recommended CCIR.
  - Summarizing the current situation of subordinate units and activities.
  - Status of the task organization.
- Developing the ISR plan (with rest of the staff). The ISR plan produces an initial ISR order to answer initial CCIR and IRs.
- Developing the unit's recommended mission statement.
- Developing the unit's operational timeline.

### **ASSISTANT CHIEF OF STAFF, G-4 (S-4), LOGISTICS**

C-7. The ACOS, G-4 (S-4) conducts mission analysis on all matters concerning logistic operations, supply, maintenance, transportation, and services. Specific responsibilities include—

- Determining current and projected supply status (specifically classes I, II, III, IV, V, VII, and IX supplies)
- Current equipment readiness status of the force and projected maintenance timelines.
- Forecasted combat vehicle and weapons status.
- Availability of transportation assets.
- Availability and status of services.
- Contracted and host-nation support.

### **ASSISTANT CHIEF OF STAFF, G-5 (S-5), CIVIL-MILITARY OPERATIONS**

C-8. The ACOS, G-5 (S-5) conducts mission analysis on all matters concerning civil-military operations (CMO). The G-5 (S-5) analyses and evaluates civil considerations (areas, structures, capabilities, organizations, people, and events) for the commander. Specific responsibilities include—

- Analysis on the effect of civilian populations on military operations.
- Analysis on the effects of military operations on the host nation and its populace.
- Displaced civilian movement, routes, and assembly areas.
- Host-nation ability to care for civilians.
- Identifying host nation resources to support military operations.

- No-strike list: including, cultural, religious, historical, and high-density civilian population areas.
- Nongovernmental and other independent organizations operating in the area of operations.

### **ASSISTANT CHIEF OF STAFF, G-6 (S-6), COMMAND, CONTROL, COMMUNICATIONS, AND COMPUTER OPERATIONS**

C-9. The ACOS, G-6 (S-6) conducts mission analysis on all matters concerning command, control, communications, and computer operations (C4OPS). Specific responsibilities include—

- Communication and information system maintenance status.
- Available communication assets, including higher and host-nation support.
- Higher headquarters communications plan.

### **ASSISTANT CHIEF OF STAFF, G-7 (S-7) INFORMATION OPERATIONS**

C-10. The ACOS, G-7 (S-7) conducts mission analysis on all matters concerning information operations. Specific responsibilities include—

- Friendly information operations (IO) capabilities and vulnerabilities.
- Enemy IO capabilities and vulnerabilities.
- Status of IO assets: including, electronic attack and psychological operations (PSYOP) units.
- Higher headquarters deception plan.

### **AIR AND MISSILE DEFENSE COORDINATOR**

C-11. The air and missile defense coordinator considers—

- Status of available air defense assets.
- Current airspace control measures (current, planned, and required).
- Current command and control measures for air defense assets (warning, weapons-control status).
- Enemy air capabilities (most likely air avenues of approach, type and number of sorties, high value target (HVT) list).

### **CHAPLAIN**

C-12. The chaplain considers—

- Status of available unit ministry teams to include coverage of identified religious preferences.
- Effect of indigenous religions on military operations.

### **CHEMICAL OFFICER**

C-13. The chemical officer considers—

- Assets available, including reconnaissance, decontamination, and smoke.
- NBC-related constraints.
- Mission-oriented protective posture (MOPP) status.

- NBC threat status.
- Troop safety criteria.

## **FIRE SUPPORT COORDINATOR**

- C-14. The fire support coordinator considers—
- Fire support capabilities and limitations.
  - Recommended tasks for fire support.
  - High-value targets.
  - Impact of IPB, target value analysis, and battlefield geometry on fire support.
  - No-strike list, including cultural, religious, historical, and high-density civilian population areas.

## **ENGINEER COORDINATOR**

- C-15. The engineer coordinator considers—
- Enemy mobility/countermobility, survivability capabilities.
  - Terrain analysis and visualization.
  - Status of available engineer assets.
  - Engineering capabilities with available assets (for example, number of fighting positions; number, size, and density of minefields; meters of antitank ditch; smoke assets; and nuclear demolition assets).
  - Environmental considerations and hazards.

## **PUBLIC AFFAIRS OFFICER**

- C-16. The public affairs officer considers—
- The operation and the information environment.
  - Level of U.S. public, host-nation and international support.
  - Media presence and facilitation in the area of operation.
  - Public affairs support to counter-deception and counter-propaganda.
  - Status of public affairs units.

## **SURGEON/MEDICAL OFFICERS**

- C-17. The surgeon/medical officer considers—
- Civilian and military medical assets available (treatment, evacuation, critical medical equipment, and personnel).
  - Class VII supply status including blood and drug supply issues.
  - Environmental health effects on military forces.
  - Medical threat (to include occupational and environment health hazards).
  - Patient estimates (medical workload).
  - Theater evacuation policy.
  - Medical troop ceiling/availability of health service support (HSS) medical treatment and evaluation resources.
  - Requirements for hospitalization, preventive medicine, veterinary, dental, and medical laboratory services and combat operational stress control.





## Appendix D

### Commander's Guidance Guidelines

This appendix provides a tool to help commanders develop planning guidance. It addresses each battlefield operating system, plus civil-military operations and information operations guidance. The content of the commander's guidance varies, depending on the situation and the echelon of command. This list is not designed to meet the needs of all situations. It is a generic list of information commanders may consider as they develop their guidance. It is neither mandatory nor desired that commanders address every item. Commander's guidance is tailored to meet specific needs based on the situation. Commanders issue guidance on only those items appropriate to a particular mission.

#### COMMANDER'S GUIDANCE DURING PLANNING

D-1. Commanders develop planning guidance from their visualization. Planning guidance may be broad or detailed, as circumstances require. Combined with the commander's intent, it conveys the essence of the commander's visualization. Commanders use their experience and judgment to add depth and clarity to their planning guidance. Effective planning guidance gives the staff a broad outline of the commander's visualization, while still allowing latitude to explore different options.

D-2. During planning, the commander's guidance focuses on course of action (COA) development, COA analysis, and COA comparison. Commanders identify an expected decisive operation and convey how they see shaping and sustaining operations contribute to it. This initial battlefield framework enables the staff to fully develop several COAs. Planning guidance states in broad terms when, where, and how the commander intends to mass the effects of combat power to accomplish the mission within the higher commander's intent. Commander's guidance also includes priorities for all combat, combat support, and combat service support elements, and how the commander envisions their contributions to the operation. Commanders use the elements of operational design to articulate their guidance.

D-3. The level of detail in the planning guidance depends on the time available, staff proficiency, and the latitude the next higher commander allows. Broad and general guidance lets a proficient staff develop flexible and effective options. Time-constrained conditions require more specific guidance. The more detailed the planning guidance, the more quickly the staff can complete the plan. However, detailed guidance incurs the risk of overlooking or insufficiently examining things that might affect mission execution.

## INTELLIGENCE

D-4. For intelligence, commanders consider—

- Enemy COAs to consider during COA development and COA analysis. At a minimum, these may be the enemy's most probable COA, most dangerous COA, or a combination of the two.
  - Enemy commander's mission.
  - Enemy commander's concept of operations.
  - Enemy critical decision points and vulnerabilities.
- Priority intelligence requirements.
- Targeting guidance.
- High-value targets.
- Desired enemy perception of friendly forces.
- Intelligence focus for each portion of the operation.
- Intelligence, surveillance, and reconnaissance guidance.
- Specific terrain and weather factors to include the identification of key terrain.
- Identification of key aspects of the environment.
- Counterintelligence guidance.
- Request for intelligence production support from non-organic resources and special collection requests.

## MANEUVER

D-5. For maneuver, commanders consider—

- Initial commander's intent:
  - Purpose of operation.
  - Key tasks.
  - Desired end state.
- COA development guidance:
  - Number of COAs to be developed.
  - COAs to consider or not consider.
  - Critical events.
  - Elements of operational design.
  - Battlefield framework:
    - The decisive operation.
    - Shaping operations.
    - Sustaining operations.
  - Task organization.
  - Task/purpose of subordinate units.
  - Forms of maneuver.
  - Reserve guidance (composition, mission, priorities, and command and control measures).
  - Security and counterreconnaissance guidance.
  - Friendly decision points.

- Possible branches.
- Positive and procedural control measures.
- Commander's critical information requirements (CCIR).
- Intelligence, surveillance, and reconnaissance guidance and priorities.
- Risk.
  - Risk to friendly forces.
  - Risk to mission accomplishment.
  - Risk to control measures.

## **FIRE SUPPORT**

D-6. For fire support, commanders consider—

- Synchronization and focus of fires with maneuver.
- High-payoff targets:
  - Methods of engagement.
  - Desired effects.
- Guidance for fires.
- Observer plan.
- Employment of combat observation and lasing teams (COLTs).
- Requirements, restrictions, and priorities for special munitions.
- Task and purpose of fires.
- Counterfire and use of radars.
- Suppression of enemy air defenses.
- Critical zones.
- Critical friendly zones and call for fire zones.
- Fire support-coordinating measures.
- Attack guidance.
- No-strike list: including, cultural, religious, historical, and high-density civilian population areas.

## **AIR DEFENSE**

D-7. For air defense, commanders consider—

- Protection priorities.
- Positioning guidance.
- Weapon control status for specific events.

## **MOBILITY, COUNTERMOBILITY, AND SURVIVABILITY**

D-8. For mobility, countermobility, and survivability, commanders consider—

- Task and purpose of each combat engineering function.
- Priority of effort and support.
- Mobility:
  - Breaching/bridging guidance.
  - Route clearance priorities.
  - Employing assets guidance.

- Countermobility:
  - Obstacle effects/emplacement guidance.
  - Scatterable mines use and duration.
- Survivability:
  - Priorities by unit and or type of equipment (for example, Q36/Q37, C2 nodes, Bradley fighting vehicles (BFVs), individual fighting positions).
  - Assets available to dig survivability positions.
- Explosive ordnance disposal (EOD). (Priority of EOD teams.)
- Nuclear, biological, and chemical defense operations:
  - Chemical reconnaissance assets.
  - Mission-oriented protective posture (MOPP) guidance.
  - Decontamination guidance.
  - Masking and unmasking guidance.
  - Employment of smoke.
  - Detection, reporting, and marking.
- Management of engineer supplies and materiel.
- Environmental guidance.

## COMBAT SERVICE SUPPORT

D-9. For combat service support (CSS), commanders consider—

- CSS priorities in terms of tactical logistics functions (manning, fueling, fixing, arming, moving the force, and sustaining soldiers and their systems).
- Positioning of key CSS assets and bases.
- Medical treatment, medical evacuation, and casualty evacuation.
- Anticipated requirements and prestockage of Class III, IV, and V supplies.
- Controlled supply rates.
- Guidance on construction and provision of facilities and installations.

## COMMAND AND CONTROL

D-10. For command and control, commanders consider—

- Rules of engagement.
- Command post positioning.
- Position of the commander.
- Integration of retransmission assets or other communications equipment.
- Liaison officer guidance.
- Force protection measures.
- Time line guidance.
- Type of order and rehearsal.
- Specific communications guidance.
- Succession of command.

## **CIVIL-MILITARY OPERATIONS**

D-11. For civil-military operations, commanders consider—

- Establishment of a civil-military operations center.
- Civil-military liaison requirements.
- Post hostility planning.

## **INFORMATION OPERATIONS**

D-12. For information operations (IO), commanders consider—

- Military deception guidance.
- Operations security (OPSEC).
- Electronic warfare.
- Physical destruction to support IO.
- Psychological operations (PSYOP).
- Public affairs.
- Information assurance.
- Physical security.
- Counterdeception.
- Counterpropaganda.
- Counterintelligence.



## Appendix E

# Estimates

A staff's most important function is to support and advise the commander throughout the operations process. The primary staff products are information and analysis. Staffs use information management to extract relevant information from a vast amount of available information. They collect, analysis, and present relevant information to commanders to assist them in achieving situational understanding and to make decisions. A tool used to support this staff function is the staff estimate. This appendix discusses estimates and their essential qualities. It provides a generic staff estimate format.

### STAFF ESTIMATES

**E-1. A *staff estimate* is an assessment of the situation and an analysis of those courses of action a commander is considering that best accomplishes the mission. It includes an evaluation of how factors in a staff section's functional area influence each COA and includes conclusions and a recommended COA to the commander.**

E-2. Staff estimates parallel the military decision making process (MDMP). Mission analysis, facts and assumptions, and the analysis of the factors of METT-TC furnish the structure for staff estimates. Estimates consist of significant facts, events, and conclusions based on analyzed data. They recommend how to best use available resources.

E-3. The commander is usually not briefed on the entire contents of every staff section's estimate; however, those estimates form the basis for each staff section's recommendation during COA approval. Complete estimates contain the information necessary to answer any question the commander poses. Any gaps in a staff estimate are identified as information requirements and submitted to the appropriate agency. Estimates can form the base for staff annexes to orders and plans.

E-4. Staff estimates normally include the elements shown in Figure E-1. The details addressed depend on a staff section's functional area. All staff sections except the intelligence section have a similar perspective: they focus on friendly COAs and their supportability. The intelligence estimate focuses on enemy most likely and dangerous COAs.

E-5. The staff assists the commander in reaching a decision by making estimates in their assigned areas of responsibility. The staff makes estimates to any operational situation and all levels of command. They use estimates to look at possible solutions to specific operational missions and requirements. Adequate,

rapid decision making and planning hinge on good, timely staff estimates. They are the basis for forming viable courses of action.

E-6. The coordinating staff and each staff principal develop facts, assessments, and information that relate to their functional field or battlefield operating system. Types of estimates include, but are not limited to—

- Operations estimate.
- Personnel estimate.
- Intelligence estimate.
- Logistics estimate.
- Civil-military operations estimate.
- Signal estimate.
- Information operations estimate.
- Special staff estimates.

E-7. Staff estimates may be written or presented orally. At the tactical level, especially during operations and exercises, estimates are usually delivered orally, supported by charts and other decision support tools. During contingency planning, especially at corps level and above, estimates are usually written. During deliberate planning at joint headquarters, estimates are always written (see JP 5-00.1).

E-8. Estimates are used to support decision making during planning and during execution. During planning, staff estimates are developed to assist the commander in choosing the best course of action (COA) to accomplish the mission. Once the commander decides on a COA, staff estimates transitions to a *running estimate* that supports decision making during execution.

## RUNNING ESTIMATES

E-9. A *running estimate* is a staff estimate, continuously updated based on new information, as the operation proceeds (see FM 6-0). It is a staff technique that supports commander's visualization and decision making. It is also a staff tool for assessing during preparation and execution. In running estimates, staffs continuously update their conclusions and recommendations based on the impact of new facts. The update, conclusions, and recommendations make running estimates useful in staff assessment. Staff sections provide these updated conclusions and recommendations to the commander as required, either by the situation or by the commander.

E-10. Because assessment is continuous throughout the operations process, staff sections maintain continuous estimates. During planning, estimates support the commander's visualization and assist the commander in selecting a course of action (COA) on which to base the plan. Thus, during planning, staff estimates focus on supporting that decision. During preparation, staff estimates focus on any command decisions that affect the ability of the unit to execute the upcoming operation. During execution, staff estimates focus on anticipated command decisions. These include, but are not limited to, decision points and decisions on whether to execute a branch or sequel.



## ESSENTIAL QUALITIES OF ESTIMATES

E-11. Comprehensive estimates consider both the quantifiable and the intangible aspects of military operations. They translate friendly and enemy strengths, weapon systems, training, morale, and leadership into combat capabilities. Preparing an estimate requires a clear understanding of weather and terrain effects and, more important, the ability to visualize the battlespace or crisis situations requiring military forces. Estimates provide a timely, accurate evaluation of the unit, the enemy, and the area of operations at a given time.

E-12. Estimates are as thorough as time and circumstances permit. The commander and staff constantly collect, process, and evaluate information. Staff members update their estimates as they receive new information or as the nature of an operation changes, such as—

- When they recognize new facts.
- When they replace assumptions with facts or find their assumptions invalid.
- When they receive changes to the mission or when changes are indicated.

E-13. Estimates for the current operation can often provide a basis for estimates for future missions as well as changes to current operations. Technological advances and near real-time information allow estimates to be continuously updated.

E-14. Estimates analyze the implications for the future and support the commander's visualization. These estimates link the current operations with future plans. The commander's visualization directs the end state. Each subordinate unit commander must also possess the ability to visualize the organization's end state. Estimates contribute to this ability.

E-15. Figure E-1 shows a generic format for written staff estimates. Doctrine proponents for staff functional areas may establish formats for written staff estimates and graphic products for their functional areas.

1. **MISSION.** Show the restated mission resulting from mission analysis.
2. **SITUATION AND CONSIDERATIONS.**
  - a. **Characteristics of the Area of Operations.**
    - (1) **Weather.** State how the military aspects of weather affect the staff section's functional area.
    - (2) **Terrain.** State how aspects of the terrain affect the staff section's functional area.
    - (3) **Civil Considerations.** State how political, economical, sociological, and psychological factors and infrastructure affect the staff section's functional area.
    - (4) **Other Pertinent Facts.** State any other pertinent facts and how they affect the staff section's functional area.
  - b. **Enemy Forces.** Discuss enemy dispositions, composition, strength, capabilities, and COAs as they affect the staff section's functional area.
  - c. **Friendly Forces.**
    - (1) List the current status of resources within the staff section's functional area.
    - (2) List the current status of other resources that affect the staff section's functional area.
    - (3) Compare requirements with capabilities and recommended solutions for discrepancies.
  - d. **Assumptions.** List any assumptions that affect the staff section's functional area.
3. **COURSES OF ACTION.**
  - a. List the friendly COAs that were war gamed.
  - b. List evaluation criteria identified during COA analysis. All staff sections use the same evaluation criteria.
4. **ANALYSIS.** Analyze each COA using the evaluation criteria identified during COA analysis.
5. **COMPARISON.** Compare COAs. Rank order COAs for each key consideration. A decision matrix usually supports comparison.
6. **RECOMMENDATION AND CONCLUSIONS.**
  - a. Recommend the most supportable COA from the specific staff perspective.
  - b. List issues, deficiencies and risks with recommendations to reduce their impacts.

Figure E-1. Generic Staff Estimate Format

## Appendix F

# Task Organization

*A temporary grouping of forces designed to accomplish a particular mission is a task organization.*

FM 3-0

This appendix discusses the fundamentals of task organization, including command and support relationships. It establishes task organization formats. FM 3-0 discusses joint and multinational command relationships and their inherent responsibilities.

### FUNDAMENTAL CONSIDERATIONS

F-1. Military units are made up of organic components. Organic parts of a unit are those listed in its table of organization and equipment (TOE). Commanders can alter an organization's organic and assigned unit relationships to better allocate assets to subordinate commanders. They also can establish temporary command and support relationships to facilitate command and control. This process of allocating available assets to subordinate commanders and establishing their command and support relationships is called *task organizing*.

F-2. Establishing clear command and support relationships is fundamental to organizing for any operation. These relationships establish clear responsibilities and authorities between subordinate and supporting units. Some command and support relationships (for example, TACON [tactical control]) limit the commander's authority to prescribe additional relationships. Knowing the inherent responsibilities of each command and support relationship allows commanders to effectively organize their forces.

F-3. Commanders designate command and support relationships to weight the decisive operation and support the concept of operations. Task organization also helps subordinate and supporting commanders understand their roles in the operation and support the commander's intent. Command and support relationships carry with them varying responsibilities to the subordinate unit by the parent and the gaining units (see figure F-1). Commanders consider these responsibilities when establishing command and support relationships.

<b>CONTENTS</b>	
<b>Fundamental Considerations</b> ..... F-1	<b>Task Organization Formats</b> ..... F-7
<b>Command and Support Relationships</b> ..... F-3	<b>Outline Format</b> ..... F-7
<b>    Command Relationships</b> ..... F-4	<b>Matrix Format</b> ..... F-9
<b>    Support Relationships</b> ..... F-6	<b>Unit Listing Sequence</b> ..... F-10

Commanders consider two organizational principles when task organizing forces:

- Maintain cohesive mission teams.
- Do not exceed subordinates' span of control capabilities.

F-4. When possible, commanders maintain cohesive mission teams. They organize task forces based on standing headquarters, their assigned forces, and habitually associated combat support (CS) and combat service support (CSS) ("slice") elements. Where this is not feasible and ad hoc organizations are formed, commanders allow time for training and establishing functional working relationships and procedures. Once commanders have organized and committed a force, they do not change its task organization unless the benefits of a change clearly outweigh the disadvantages. Reorganizations may result in a loss of time, effort, and tempo. Logistic considerations may also preclude quick reorganization.

F-5. Commanders are careful not to exceed the span of control capabilities of subordinates. Span of control refers to the number of subordinate units under a single commander. Commanders should not be given more units than they can effectively command and control. This number is situation-dependent. Although span of control varies with the situation, commanders can effectively command two to five subordinate units. Allocating subordinates more units gives them greater flexibility and increases options and combinations. However, as the number increases, commanders, at some point, lose the ability to consider each unit individually and begin to think of units as a single, inflexible mass. In such circumstances, the only way to reintroduce flexibility is to create another echelon of command by grouping elements into a smaller number of parts.

F-6. Staff estimates and course of action (COA) analysis provide information that helps commanders determine the best task organization. An effective task organization—

- Facilitates the commander's intent and concept of operations.
- Retains flexibility within the concept of operations.
- Weights the decisive operation.
- Adapts to conditions imposed by the factors of mission, enemy, terrain and weather, troops and support available, time available and civil considerations (METT-TC).
- Creates effective combined arms teams.
- Provides mutual support among units.
- Ensures flexibility to meet unforeseen events and support future operations.
- Allocates resources with minimum restrictions on their employment.
- Ensures unity of command and synchronization of effort through proper use of command and support relationships.
- Offsets limitations and maximizes the potential of all forces available.
- Exploits enemy vulnerabilities.

F-7. Creating an appropriate task organization requires understanding—

- The mission, including the higher commander's intent and concept of operations.

- The tenets of Army operations (see FM 3-0) and basic tactical concepts. (See FM 3-90).
- The battlefield organization.
- The roles and interrelations of the battlefield operating systems.
- The status of available forces, including morale, training, and equipment capabilities.
- Specific unit capabilities, limitations, strengths, and weaknesses.
- The risks inherent in the plan.
- Subordinate commanders' abilities, especially their ability to apply combined arms doctrine.

F-8. During COA analysis, commanders identify what combat power they need, and where, when, and how frequently they will need it. They approve or modify the staff's recommended task organization based on their evaluation of the factors listed above and information from estimates and COA analysis.

F-9. Formal task organization and the change from generic to specific units begin after COA analysis, when commanders assign missions to subordinate commanders. Commanders assign tasks to subordinate headquarters and determine if subordinate headquarters have enough combat power, reallocating combat power as necessary. They then define command and support relationships for subordinate units and decide the priorities of support. Commanders allocate maneuver units two levels down to commanders one level down. There may be exceptions for CS units—for example, at corps level, engineer or military police companies may be allocated to divisions. The commander allocates CSS units as needed, regardless of size.

F-10. In allocating assets, the commander and staff consider the—

- Task organization for the ongoing operation.
- Potential adverse effect of breaking up cohesive teams by changing the task organization.
- Time necessary to realign the organization after receipt of the task organization.
- Limits on control over supporting units provided by higher headquarters.

F-11. Definitions of support or command relationships do not cover every situation. Some circumstances require commanders to establish nonstandard command relationships. When establishing such a relationship commanders assign responsibility for the necessary support tasks in the task organization.

## COMMAND AND SUPPORT RELATIONSHIPS

F-12. Army commanders build combined arms organizations using command and support relationships. Command relationships define command responsibility and authority. Support relationships define the purpose, scope, and effect desired when one capability supports another.

F-13. A command or support relationship is not a mission assignment; mission assignments go in paragraph 3b or 3c of the basic operation order (OPORD) or operation plan (OPLAN). Operation plans and orders state specifically the

command and support relationships that place the unit under a commanding headquarters. If possible, show all command and support relationships in the task organization.

## COMMAND RELATIONSHIPS

F-14. Command relationships establish the degree of control and responsibility commanders have for forces operating under their control. Army command relationships include assigned, attached, operational control (OPCON), and TACON. (See FM 3-0).

F-15. *Assign* is to place units or personnel in an organization where such placement is relatively permanent, and/or where such organization controls and administers the units or personnel for the primary function, or greater portion of the functions, of the unit or personnel (JP 1-02). Unless specifically stated, this relationship includes administrative control (ADCON).

F-16. *Attach* is the placement of units or personnel in an organization where such placement is relatively temporary (JP 1-02). A unit that is temporarily placed into an organization is attached.

F-17. *Operational control* (OPCON) is transferable command authority that may be exercised by commanders at any echelon at or below the level of combatant command. Operational control is inherent in combatant command (command authority). Operational control may be delegated and is the authority to perform those functions of command over subordinate forces involving organizing and employing commands and forces, assigning tasks, designating objectives, and giving authoritative direction necessary to accomplish the mission. Operational control includes authoritative direction over all aspects of military operations and joint training necessary to accomplish missions assigned to the command. Operational control should be exercised through the commanders of subordinate organizations. Normally this authority is exercised through subordinate joint force commanders and service and/or functional component commanders. Operational control normally provides full authority to organize commands and forces, and to employ those forces as the commander in operational control considers necessary to accomplish assigned missions. Operational control does not, in and of itself, include authoritative direction for logistics or matters of administration, discipline, internal organization, or unit training (JP 1-02).

F-18. *Tactical control* (TACON) is command authority over assigned or attached forces or commands, or military capability or forces made available for tasking, that is limited to the detailed and, usually, local direction and control of movements or maneuvers necessary to accomplish missions or tasks assigned. Tactical control is inherent in operational control. Tactical control may be delegated to, and exercised at any level at or below the level of combatant command (JP 1-02). Tactical control allows commanders below combatant command level to apply force and direct tactical use of logistic assets but does not provide authority to change organizational structure or direct administrative and logistic support.

F-19. Figure F-1 shows inherent responsibilities of each command relationship. Command responsibilities, responsibilities for service support, and authority to organize or reassign component elements of a supporting force remain with the

higher headquarters or parent unit unless the authorizing commander specifies otherwise.

		INHERENT RESPONSIBILITIES ARE:							
IF RELATIONSHIP IS:		Has Command Relationship with:	May Be Task Organized by:	Receives CSS from:	Assigned Position or AO by:	Provides Liaison to:	Establishes/ Maintains Communications with:	Has Priorities Established by:	Gaining Unit Can Impose Further Command or Support Relationship of:
COMMAND	Attached	Gaining unit	Gaining unit	Gaining unit	Gaining unit	As required by gaining unit	Unit to which attached	Gaining unit	Attached; OPCON; TACON; GS; GSR; R; DS
	OPCON	Gaining unit	Parent unit and gaining unit; gaining unit may pass OPCON to lower HQ. Note 1	Parent unit	Gaining unit	As required by gaining unit	As required by gaining unit and parent unit	Gaining unit	OPCON; TACON; GS; GSR; R; DS
	TACON	Gaining unit	Parent unit	Parent unit	Gaining unit	As required by gaining unit	As required by gaining unit and parent unit	Gaining unit	GS; GSR; R; DS
	Assigned	Parent unit	Parent unit	Parent unit	Gaining unit	As required by parent unit	As required by parent unit	Parent unit	Not Applicable
SUPPORT	Direct Support (DS)	Parent unit	Parent unit	Parent unit	Supported unit	Supported unit	Parent unit; Supported unit	Supported unit	Note 2
	Reinforcing (R)	Parent unit	Parent unit	Parent unit	Reinforced unit	Reinforced unit	Parent unit; Reinforced unit	Reinforced unit; then parent unit	Not Applicable
	General Support Reinforcing (GSR)	Parent unit	Parent unit	Parent unit	Parent unit	Reinforced unit and as required by parent unit	Reinforced unit and as required by parent unit	Parent unit; then Reinforced unit	Not Applicable
	General Support (GS)	Parent unit	Parent unit	Parent unit	Parent unit	As required by parent unit	As required by parent unit	Parent unit	Not Applicable

NOTE 1. In NATO, the gaining unit may not task organize a multinational unit (see TACON).  
 NOTE 2. Commanders of units in DS may further assign support relationships between their subordinate units and elements of the supported unit after coordination with the supported commander.

Figure F-1. Command and Support Relationships

F-20. When commanders establish command relationships they determine if the command relationship includes ADCON. *Administrative control* is direction or

exercise of authority over subordinate or other organizations in respect to administration and support, including organization of service forces, control of resources and equipment, personnel management, unit logistics, individual and unit training, readiness, mobilization, demobilization, discipline, and other matters not included in the operational missions of the subordinate or other organizations (JP 1-02). ADCON includes personnel management, control of resources and equipment, discipline, and other matters not included in operational missions.

F-21. ADCON is equivalent to administration and support responsibilities identified in Title 10 United States Code (USC). This is the authority necessary to fulfill military department statutory responsibilities for administration and support. ADCON of an Army unit must remain in Army channels. It cannot be transferred to a unit of another service.

F-22. Attachment orders normally state whether parent unit retains ADCON of the unit. If it does not, the attachment order specifically states that the gaining unit has ADCON. For OPCON and TACON, parent units retain ADCON.

## SUPPORT RELATIONSHIPS

F-23. Support relationships define the purpose, scope, and effect desired when one capability supports another. Support relationships establish specific responsibilities between supporting and supported units (see figure F-1). Army support relationships are direct support (DS), general support (GS), general support reinforcing (GSR), and reinforcing (R).

- **Direct support is a support relationship requiring a force to support another specific force and authorizing it to answer directly to the supported force's request for assistance.** (Joint doctrine considers DS to be a mission rather than a support relationship. Otherwise, the joint and Army definitions are the same.) A unit assigned a DS relationship retains its command relationship with its parent unit, but is positioned by and has priorities of support established by the supported unit.
- **General support is a support relationship assigned to a unit to support the force as a whole and not to any particular subdivision thereof.** (Joint doctrine considers GS to be a mission rather than a support relationship. Otherwise, the joint and Army definitions are the same.) Units assigned a GS relationship are positioned and have priorities established by their parent unit.
- **Reinforcing is a support relationship in which the supporting unit assists the supported unit to accomplish the supported unit's mission. Only like units (for example, artillery to artillery, intelligence to intelligence, armor to armor) can be given a reinforcing/reinforced mission.** (Joint doctrine considers reinforcing to be a mission rather than a support relationship. Otherwise, the joint and Army definitions are the same.) A unit assigned a reinforcing relationship retains its command relationship with its parent unit, but is positioned by the reinforced unit. A unit that is reinforcing has priorities of support established by the reinforced unit, then the parent unit.



- **General support-reinforcing** is a support relationship assigned to a unit to support the force as a whole and to reinforce another similar-type unit. (The joint definition limits GSR to field artillery units. The Army definition allows other types of units to conduct GSR relationships.)

A unit assigned a GSR relationship is positioned by its parent unit and has priorities first established by its parent unit, and secondly by the reinforced unit.

## TASK ORGANIZATION FORMATS

F-24. There are two task organization formats: outline and matrix. The sequence in which units are listed is the same for both methods. The chief of staff or executive officer selects the method for a given OPLAN or OPORD. The following conventions apply to both formats.

### OUTLINE FORMAT

F-25. The outline format lists all units under the headquarters to which they are allocated or that they support (see Figure F-2). Place long or complex task organizations in annex A of the plan or order.

<p>List subordinate units under the C2 headquarters to which they are assigned, attached, or in support. Place DS units below the units they support. Indent subordinate and supporting units two spaces. Identify relationships other than attached with parenthetical terms—for example, (OPCON) or (DS).</p>	<p><b>148 BDE (continued)</b>          (CORPS) (R: 1-128 FA)          E/179 ADA (SFV/S) (DS)          TM 1,2/HHB/1-213 ADA (Sentinel)          648 EN BN          48 CML PLT          248 MI CO (DS)          48 MP PLT          TM A, B, D/1/A/24 SIG BN          DET C&amp;D/A/435 CA BN          BPSE/A/210 PSYOPS BN          148 SB (DS)          2/1/849 MED CO (AIR AMB) (DS)          2/855 MED CO (GRD AMB) (DS)          2/2/205 QM COLL CO (MA)          843 FST (DS)</p> <p><b>228 BDE</b>          1-128 IN (M) (-)          1-258 AR          B/292 CAV          E/263 ADA (SFV/S) (DS)          TM 3&amp;4/HHB/1-213 ADA          188 EN BN          228 CML PLT          228 MI CO (DS)          228 MP PLT          TM A, B &amp; D/2/A/24 SIG BN          173 SB (DS)          3/1/849 MED CO (AIR AMB) (DS)          3/855 MED CO (GRD AMB) (DS)          3/2/205 QM COLL CO (MA)          844 FST (DS)</p> <p><b>52 AVN BDE</b>          171 ATK HEL BN          172 ATK HEL BN          52 ASLT HEL BN          52 CMD AVN CO          TM D/1/C/24 SIG BN</p> <p><b>52 ID DIVARTY</b>          HHB          1-178 FA (GSR: 1-123 FA, O/O DS 228 BDE)</p>	<p><b>52 ID DIVARTY (continued)</b>          3/C/1-44 FA (TA, Q-36)          C/1-44 FA (TA) (-)          87 FA BDE (R)          2-368 FA (MLRS)          2-485 FA (155, SP) (M109A6)          5080 EN CO (CSE) (-) (O/O attached to 501 EN BN (C) (M))          TM D/2/C/24 SIG BN</p> <p><b>DIV TROOPS</b>          52 ID RAOC          C/1-128 IN (M) (TCF)          MORT/1-128 IN (M)          1/22 CAV          52 ID (M) EN BDE (-)          901 EN BN (-) (C) (M)          3/5080 EN CO (CSE)          1-213 ADA (-)          402 CM BN          401 CM CO (Smoke) (-)          402 CM CO (Smoke)          403 CM CO (Decon) (Corps) (-)          404 CM CO (Decon) (Corps)          1/51 CM CO (Recon) (-)          624 MI BN (-)          52 MP CO (-)          52 BAND (OPCON)          107 MP CO (CORPS) (DS)          52 SIG BN (-)          485 CA BN (-)          A/200 PSYOPS BN (-)</p> <p><b>DISCOM</b>          D/52 SIG (-)          MMC          744 MSB          849 MED CO (AIR AMB) (-) (DS)          855 MED CO (GRD AMB) (-) (DS)          184 PSB          2/205 QM CO (MA) (-)          3 (SLCR)/201 FLD SVC CO (DS)          20 FIN BN</p>
---	---	---

Figure F-2. Outline Format for a Task Organization (Division)

## MATRIX FORMAT

F-26. The matrix format displays a task organization in terms of unit type and relationship to subordinate headquarters. It is especially convenient at brigade and below (see Figure F-3). The matrix format has several advantages:

- It displays, at a glance, command and support relationships for subordinate units and the force as a whole.
- It shows the organization for combat of CS and CSS elements.
- It conserves time and eliminates redundancy by not listing organic units of a parent organization.
- It makes accounting for each unit easier.

F-27. Use the following conventions when preparing a corps or division task organization as a matrix:

- List major subordinate command headquarters along the top of the matrix. List corps troops or division troops in the last column on the right.
- List attached maneuver units in the maneuver space under the gaining headquarters. Do not list organic maneuver units.
- For corps orders, do not list divisional brigades in the maneuver space. However, for division orders, list attached maneuver battalions under gaining brigades.
- List the support “slice” that comes with an attached task force in the maneuver space under the gaining command.
- Array CS units in their respective spaces under the supported headquarters.
- Specify command or support relationships for units not attached.

F-28. Use the following conventions when preparing a brigade or battalion task organization as a matrix:

- List major subordinate maneuver commands or task force designations along the top of the matrix. List brigade control or battalion control in the last space on the right.
- For brigade orders, list maneuver battalions separately down the left column instead of using the normal maneuver label. On battalion orders, list maneuver companies.
- If no cross-attachment occurs, leave the space blank.
- If maneuver units or elements (companies or platoons) are cross-attached, list them under the appropriate headquarters.
- Array CS units along their respective space in columns of the appropriate headquarters.
- Specify a command or support relationship for units not attached.

F-29. Task organization matrices are not recognized by the other armed forces or by foreign armies. Do not use matrix formats during joint or multinational operations.

	1st Bde	2d Bde	3d Bde	201 ACR	DIVARTY	DIV TRP	DISCOM	TCF
<b>MVR</b>	TF 3-5 TF 3-8		C/3-3 Armor	D/3-23 Cav		1054 ROC		C/3-82 Mech
<b>AVN</b>				C/54 Avn (OPCON)				
<b>FA</b>	3-40 FA (DS) 3-43 FA (R)	3-41 FA (DS)	3-42 FA (DS)	61 FA Bde				
<b>ADA</b>				A/3-441 ADA				
<b>CML</b>	1/54 Cml Co	2/54 Cml Co	3/54 Cml Co					
<b>ENGR</b>	A, 54 EN (DS)	B/54 EN (DS)	C/54 EN (DS)	D/54 EN		C, 550 EN Cbt Bn (Hv) (-)		
<b>MI</b>	1/A/54 MI (DS) 10 GSR Tms	2/A/54 MI (DS) 6 GSR Tms	3/A/54 MI (DS) 5 GSR Tms					
<b>MP</b>								
<b>SIG</b>								
<b>CSS</b>								
<b>SOF</b>	1 Plt, Co. C, 55th CA TAC Spt Bn	2/C/55 CA TAC Spt Bn	3/C/55 CA TAC Spt Bn			288th PSYOP Co. SOCCE 190	4/C/55 CA TAC Spt Bn	

Figure F-3. Matrix Format for a Task Organization (Division)

**UNIT LISTING SEQUENCE**

F-30. List major subordinate control headquarters in the sequence shown in Figure F-4, regardless of the format used. If applicable, list task organizations according to phases of the operation.

F-31. Group units by command and control headquarters. List major subordinate maneuver units first (for example, 1st Bde; 2-30 IN; A, 1-77 AR). Place them in alphabetical or numerical order. List brigade task forces ahead of brigades, battalion task forces before battalions, and company teams before companies. Follow maneuver headquarters with the field artillery (for example, division artillery [DIVARTY], division units controlled by the force headquarters, and the echelon support command [DISCOM]). List all units C2 to the force headquarters under a single heading.

F-32. Use a plus (+) symbol when attaching one or more sub-elements of a similar function to a headquarters. Use a minus symbol (-) when deleting one or more sub-elements of a similar function to a headquarters. Always show the symbols in parenthesis. Do not use a plus symbol when the receiving headquarters is a combined arms task force or company team. Do not use plus and minus symbols together (as when a headquarters detaches one element and receives attachment of another); use the symbol that portrays the element's combat power with respect to other similar elements. Do not use either symbol

when two units swap sub-elements and their combat power is unchanged. Here are some examples:

- C Company loses one platoon to A Company: The battalion task organization shows A Co. (+) and C Co. (-).
- 3-16th Infantry receives a tank company from 4-63d Armor: The brigade task organization shows TF 3-16 IN and 4-63 AR (-).
- B Company receives a tank platoon from the tank company OPCON to the battalion and detaches one infantry platoon to the tank company: The battalion task organization shows TM B and TM Tank.
- The 53d Mechanized Division receives an enhanced separate brigade from corps. The corps task organization shows 53d ID (M) (+).

F-33. When the effective attachment time of a nonorganic unit to another unit differs from the effective time of the plan or order, add the effective attachment time in parentheses after the attached unit—for example, 1-82 AR (OPCON 2d Bde Ph II). List this information in either the task organization (preferred) or in paragraph 1c of the plan or order, but not both. For clarity, list subsequent command or support relationships under the task organization in parentheses following the affected unit—for example, “...on order, OPCON to 2d Brigade” is written (O/O OPCON 2d Bde).

F-34. Give the numerical designations of units in Arabic numerals, even if they are shown as Roman numbers in graphics—for example, show X Corps as 10th Corps.

F-35. During multinational operations, insert the country code between the numeric designation and the unit name—for example, 3d (GE) Corps. (FM 1-02 contains authorized country codes.)

F-36. Use abbreviated designations for organic units. Use the full designation for nonorganic units—for example, 2-607 FA (155, SP) (Corps), rather than 2-607 FA.

F-37. Designate task forces with the last name of the task force commander (for example, TF WILLIAMS), a code name (for example, TF WARRIOR), or a number (for example, TF 47 or TF 1-77 AR).

	<b>Corps</b>	<b>Division</b> (Note 1)	<b>Brigade</b> (Note 1)	<b>Battalion</b> (Note 1)	<b>Company</b>
<b>MANEUVER</b>	Divisions <ul style="list-style-type: none"> <li>•Infantry</li> <li>•Light Infantry</li> <li>•Mechanized</li> <li>•Motorized</li> <li>•Air Assault</li> <li>•Airborne</li> <li>•Armored</li> </ul> Separate ground maneuver brigades or battalions Aviation ACR SOF <ul style="list-style-type: none"> <li>•Ranger</li> <li>•Special Forces</li> </ul>	Brigade-size ground <ul style="list-style-type: none"> <li>•Maneuver TFs named TFs in alphabetical order</li> <li>•Numbered TFs in numerical order</li> <li>•Brigades in numerical order</li> </ul> Task Forces of battalion size <ul style="list-style-type: none"> <li>•Named TFs in alphabetical order</li> <li>•Numbered TFs in numerical order</li> </ul> Cavalry squadron (Note 2)	Battalion TFs Battalions <ul style="list-style-type: none"> <li>•Infantry</li> <li>•Light Infantry</li> <li>•Mechanized</li> <li>•Air Assault</li> <li>•Airborne</li> <li>•Armor</li> </ul> Company Teams Companies Aviation Cavalry or Reconnaissance	Company Teams <ul style="list-style-type: none"> <li>• Named teams in alphabetical order</li> <li>•Letter designated teams in alphabetical order</li> </ul> Companies <ul style="list-style-type: none"> <li>•Infantry</li> <li>•Light Infantry</li> <li>•Mechanized</li> <li>•Air Assault</li> <li>•Airborne</li> <li>•Armor</li> <li>•Antitank Scout Platoon</li> </ul>	Organic Platoons Attached Platoons
<b>CS</b>  (Notes 3 and 4)	Field Artillery Air Defense Chemical Engineers LRSC Military Intelligence Military Police Signal SOF <ul style="list-style-type: none"> <li>•Civil Affairs</li> <li>•Psychological Operations</li> <li>Public Affairs</li> </ul>	Field Artillery Air Defense Artillery Chemical Engineers (Note 5) Military Intelligence Military Police Signal Public Affairs	Field Artillery Air Defense Artillery Chemical Engineers (Note 6) Military Intelligence Military Police Signal Public Affairs	Mortar Platoon Air Defense Artillery Chemical Engineers Military Intelligence	
<b>CSS</b>  (Notes 7 and 8)	Corps support command	Division support command	Support battalion	Support platoon	
<b>HQ Control troops</b>		(See note 9)			

ACR – armored cavalry regiment      LRSC – long range surveillance company      SOF – special operations forces

**NOTES:**

1. List separate ground maneuver brigades, battalions, and companies in the same order as divisions are listed in the corps structure.
2. List the cavalry squadron separately when it is operating under division control.
3. List CS units by the size of command echelon, then list them again numerically; and then alphabetically; for example, list larger units before smaller units of the same type.
4. List multiple CS units of the same type using the sequence of size, numerical designation, and alphabet.
5. List the engineer battalion under division troops for light divisions with only one engineer battalion.
6. List the engineer company under brigade troops when only one engineer company is task-organized to the brigade (as is done in light divisions).
7. List multiple CSS units of the same type using the sequence of size, numerical designation, and alphabet.
8. List CSS units by size of command echelon, then list them again numerically, and then alphabetically.
9. Headquarters security forces are examples of units listed under HQ control troops.

**Figure F-4. Order of Listing Units in a Task Organization**

## Appendix G

# Plans and Orders

This appendix explains how to construct plans and orders for Army units at corps level and below. General information on the content and how to construct plans and orders is followed by examples. For guidance on the preparation of joint plans and orders, refer to JP 5-0; JP 5-00.1; JP 5-00.2; and CJCSM 3122.03A. Figure G-1 provides a list of the figures in this appendix. Figures, beginning on page G-17, contain examples and procedures for completing plans, orders, and annexes.

## CHARACTERISTICS

G-1. Plans and orders are the means by which commanders express their visualization, commander's intent, and decisions. They focus on results the commander expects to achieve. Plans and orders form the basis commanders use to synchronize military operations. They encourage initiative by providing the what and why of a mission, and leave the how-to-accomplish-the-mission to subordinates. They give subordinates the operational and tactical freedom to accomplish the mission by providing the minimum restrictions and details necessary for synchronization and coordination. Plans and orders—

- Permit subordinate commanders to prepare supporting plans and orders.

## CONTENTS

<b>Characteristics</b> .....	<b>G-1</b>	<b>Naming Conventions</b> .....	<b>G-9</b>
<b>Types of Plans</b> .....	<b>G-3</b>	<b>Classification Markings</b> .....	<b>G-9</b>
<b>Types of Orders</b> .....	<b>G-4</b>	<b>Expressing Unnamed Dates - Times</b> ...	<b>G-10</b>
<b>Operation Orders</b> .....	<b>G-5</b>	<b>Expressing Time</b> .....	<b>G-11</b>
<b>Service Support Orders</b> .....	<b>G-5</b>	<b>Identifying Pages</b> .....	<b>G-11</b>
<b>Movement Orders</b> .....	<b>G-5</b>	<b>Numbering Pages</b> .....	<b>G-11</b>
<b>Warning Orders</b> .....	<b>G-6</b>	<b>Attachments (Annexes, Appendixes, Tabs,</b>	
<b>Fragmentary Orders</b> .....	<b>G-6</b>	<b>and Enclosures)</b> .....	<b>G-12</b>
<b>Techniques for Issuing Orders</b> .....	<b>G-7</b>	<b>Standing Operating Procedures</b> .....	<b>G-13</b>
<b>Verbal Orders</b> .....	<b>G-7</b>	<b>Matrices and Templates</b> .....	<b>G-14</b>
<b>Graphics</b> .....	<b>G-7</b>	<b>Decision Support Template</b> .....	<b>G-14</b>
<b>Overlays</b> .....	<b>G-7</b>	<b>Synchronization Matrix</b> .....	<b>G-16</b>
<b>Overlay Orders</b> .....	<b>G-7</b>	<b>Execution Matrix</b> .....	<b>G-16</b>
<b>Administrative Instructions for Preparing</b>		<b>Examples and Procedures for Completing</b>	
<b>Plans and Orders</b> .....	<b>G-8</b>	<b>Plans, Orders, and Annexes</b> .....	<b>G-16</b>
<b>General Information</b> .....	<b>G-8</b>	<b>List of Figures</b> .....	<b>G-17</b>
<b>Abbreviations</b> .....	<b>G-8</b>		
<b>Place and Direction Designations</b> .....	<b>G-8</b>		

- Implement instructions derived from a higher commander's plan or order.
- Focus subordinates' activities.
- Provide tasks and activities, constraints, and coordinating instructions necessary for mission accomplishment.
- Encourage agility, speed, and initiative during execution.
- Convey instructions in a standard, recognizable, clear, and simple format.

G-2. The amount of detail provided in a plan or order depends on several factors, to include the experience and competence of subordinate commanders, cohesion and tactical experience of subordinate units, and complexity of the operation. Commanders balance these factors with their guidance and commander's intent, and determine the type of plan or order to issue. To maintain clarity and simplicity, plans and orders include annexes only when necessary and only when they pertain to the entire command. Annexes contain the details of support and synchronization necessary to accomplish the mission.

G-3. Characteristics of good operation plans (OPLANs) and operation orders (OPORDs) are listed below:

- **Contain Critical Facts and Assumptions.** The commander and staff evaluate all facts and assumptions. They retain for future reassessment only those facts and assumptions that directly affect an operation's success or failure. Assumptions are stated in OPLANs, but not in OPORDs.
- **Authoritative Expression.** The plan or order reflects the commander's intention and will. Therefore, its language is direct. It unmistakably states what the commander wants subordinate commands to do.
- **Positive Expression.** Instructions in plans and orders are stated in the affirmative: for example, "The trains will remain in the assembly area"; instead of, "The trains will not accompany the unit." As an exception, some constraints are stated in the negative: for example, "Do not cross Phase Line Blue before H+2."
- **Avoid Qualified Directives.** Do not use meaningless expressions, such as, "as soon as possible (ASAP)." Indecisive, vague, and ambiguous language leads to uncertainty and lack of confidence. For example, do not use "try to retain"; instead, say "retain until." Avoid using unnecessary modifiers and redundant expressions, such as "violently attack" or "delay while maintaining enemy contact." Use "attack" or "delay." Army doctrine already requires attacking violently and maintaining enemy contact during delays.
- **Balance.** Balance centralized and decentralized control. The commander determines the appropriate balance for a given operation based on mission, enemy, terrain and weather, troops and support available, time available, and civil considerations (METT-TC). During the chaos of battle, it is essential to decentralize decision authority to the lowest practical level. Over centralization slows action and inhibits initiative. However, decentralized control can cause loss of precision. The commander constantly balances competing risks while recognizing that loss of precision is usually preferable to inaction.



- **Simplicity.** Reduce all elements to their simplest form. Eliminate elements not essential to understanding. Simple plans are easier to understand.
- **Brevity.** Be clear and concise. Include only necessary details. Use short words, sentences, and paragraphs. Do not include material covered in SOPs (standing operating procedures). Refer to those SOPs instead.
- **Clarity.** Everyone using the plan or order must readily understand it. Do not use jargon. Eliminate every opportunity for misunderstanding the commander's exact, intended meaning. Use acronyms unless clarity is hindered. Keep the plan or order simple. Use only doctrinal terms and graphics.
- **Completeness.** Provide all information required for executing the plan or order. Use doctrinal control measures that are understandable, and allow subordinates to exercise initiative. Provide adequate control means (headquarters and communications). Clearly establish command and support relationships. Fix responsibility for all tasks.
- **Coordination.** Provide for direct contact among subordinates. Fit together all battlefield operating systems (BOS) for synchronized, decisive action. Identify and provide for mutual support requirements while minimizing the chance of fratricide.
- **Flexibility.** Leave room for adjustments to counter the unexpected. The best plan provides for the most flexibility.
- **Timeliness.** Send plans and orders to subordinates in adequate time to allow them to plan and prepare their own actions. In the interest of timeliness, accept less than optimum products only when time is short.

G-4. Figure G-30 is a verbatim transcript of an order issued by VII Corps in World War II. It represents a typical order in the European Theater of Operations. Its brevity and simplicity are remarkable, considering that the operation involved six divisions. Several factors made this simplicity and brevity possible: VII Corps and its subordinate divisions were well trained, with detailed and practiced SOPs. They were combat tested, with experienced and cohesive staffs. Finally, there was trust up and down the chain of command. Emulating these conditions allows commanders to issue simple and concise plans and orders.

## TYPES OF PLANS

G-5. A *plan* is a design for a future or an anticipated operation. Plans come in many forms and vary in scope, complexity, and length of planning horizons. Strategic plans cover the overall conduct of a war. Operational or campaign plans cover a series of related military operations aimed at accomplishing a strategic or operational objective within a given time and space. Tactical plans cover the employment of units in operations, including the ordered arrangement and maneuver of units in relation to each other and to the enemy in order to use their full potential.

G-6. An *operation plan* is any plan for the preparation, execution, and assessment of military operations. (The Army definition eliminates details of the joint definition that apply only to joint operations. See Glossary and JP 5-0.) An OPLAN becomes an OPORD when the commander sets an execution time.

Commanders may begin preparation for possible operations by issuing an OPLAN. (See Figure G-2 and Figure G-4.)

G-7. A ***service support plan*** is a plan that provides information and instructions covering service support for an operation. Estimates of the command's operational requirements are the basis for a service support plan. The service support plan becomes a service support order when the commander sets an execution time for the OPLAN that the service support plan supports. (See Figure G-5.)

G-8. A *supporting plan* is an operation plan prepared by a supporting commander or a subordinate commander to satisfy the requests or requirements of the supported commander's plan (JP 5-0).

G-9. A *contingency plan* is a plan for major contingencies that can reasonably be anticipated in the principal geographic sub-areas of the command (JP 1-02). Army forces prepare contingency plans as part of all operations. Contingency plans may take the form of branches or sequels. Operations never proceed exactly as planned. Commanders prepare contingency plans to gain flexibility. Visualizing and planning branches and sequels are important because they involve transitions—changes in mission, type of operation, or forces required for execution. Unless conducted (planned, prepared, executed, and assessed) efficiently, transitions can reduce tempo, slow momentum, and give up the initiative.

G-10. A *branch* is a contingency plan or course of action (an option built into the basic plan or course of action) for changing the mission, disposition, orientation, or direction of movement of the force to aid success of the current operation, based on anticipated events, opportunities, or disruptions caused by enemy actions. Army forces prepare branches to exploit success and opportunities, or to counter disruptions caused by enemy actions (FM 3-0). Although commanders cannot anticipate every possible threat action, they prepare branches for the most likely ones. Commanders execute branches to rapidly respond to changing conditions.

G-11. *Sequels* are operations that follow the current operation. They are future operations that anticipate the possible outcomes—success, failure, or stalemate—of the current operation (FM 3-0). A counteroffensive, for example, is a logical sequel to a defense; exploitation and pursuit follow successful attacks. Executing a sequel normally begins another phase of an operation, if not a new operation. Commanders consider sequels early and revisit them throughout an operation. Without such planning during current operations, forces may be poorly positioned for future opportunities, and leaders unprepared to retain the initiative. Branches and sequels have execution criteria. Commanders carefully review them before execution and update them based on assessment of current operations.

## TYPES OF ORDERS

G-12. An *order* is a communication that is written, oral, or by signal, which conveys instructions from a superior to a subordinate. In a broad sense, the terms “order” and “command” are synonymous. However, an order implies discretion as to the details of execution, whereas a command does not (JP 1-02).

Combat orders pertain to operations and their service support. Combat orders include—

- OPORDs.
- Service support orders.
- Movement orders.
- Warning orders (WARNOs).
- Fragmentary orders (FRAGOs).

## OPERATION ORDERS

G-13. An *operation order* is a directive issued by a commander to subordinate commanders for the purpose of effecting the coordinated execution of an operation (JP 1-02). Traditionally called the five paragraph field order, an OPORD contains, as a minimum, descriptions of the following:

- Task organization.
- Situation.
- Mission.
- Execution.
- Administrative and logistic support.
- Command and signal for the specified operation.

OPORDs always specify an execution date and time (see Figures G-2 and G-4).

## SERVICE SUPPORT ORDERS

G-14. A ***service support order*** is an order that directs the service support of operations, including administrative movements (see Figure G-5). Service support orders form the basis for the orders of supporting commanders to their units. They provide information on combat service support (CSS) to supported elements. Service support orders are issued with an OPORD. They may be issued separately, when the commander expects the CSS situation to apply to more than one OPLAN/OPORD. At division and corps levels, a service support order may replace an OPORD's service support annex. In those cases, paragraph 4 of the OPORD refers to the service support order. Staffs at brigade and lower levels may cover all necessary CSS information in paragraph 4 of the OPORD. The service support order follows the same format as the OPORD. It is usually in writing and may include overlays, traces, and other annexes.

G-15. The logistics officer has primary coordinating responsibility for preparing, publishing, and distributing the service support order. Other staff officers, both coordinating and special, prepare parts of the order concerning their functional areas.

## MOVEMENT ORDERS

G-16. A *movement order* is an order issued by a commander covering the details for a move of the command (JP 1-02) (see Figure G-6). Movement orders usually concern administrative moves (see FM 3-90). Normally, these movements occur in the communications zone or rear area. The logistics officer has primary coordinating staff responsibility for planning and coordinating movements. This includes preparing, publishing, and distributing movement orders. Other coordinating and special staff officers assist the logistics officer. These may

include the operations officer, provost marshal, transportation officers, and movement control personnel.

G-17. When conducting ground movements in the rear area of the combat zone where enemy interference is expected, a movement order may become an annex to an OPORD or service support order. (Under the North Atlantic Treaty Organization (NATO), this annex is called the movement annex.) The operations officer plans and coordinates these tactical movements.

## WARNING ORDERS

G-18. The *warning order* is a preliminary notice of an order or action, which is to follow (JP 1-02) (see Figure G-7). WARNOs help subordinate units and staffs prepare for new missions. They increase subordinates' planning time, provide details of the impending operation, and detail events that accompany preparation and execution. The amount of detail a WARNO includes depends on the information and time available when it is issued and the information subordinate commanders need for proper planning and preparation. The words "warning order" precede the message text. With the commander's (or chief of staff's or executive officer's) approval, a coordinating or special staff officer may issue a WARNO.

G-19. A WARNO informs recipients of tasks they must do now or notifies them of possible future tasks. However, a WARNO does not authorize execution other than planning unless specifically stated. A WARNO follows the OPORD format. It may include some or all of the following information:

- Series numbers, sheet numbers and names, editions, and scales of maps required (if changed from the current OPORD).
- The enemy situation and significant intelligence events.
- The higher headquarters' mission.
- Mission or tasks of the issuing headquarters.
- The commander's intent statement.
- Orders for preliminary actions, including intelligence, surveillance, and reconnaissance (ISR) operations.
- Coordinating instructions (estimated timelines, orders group meetings, and the time to issue the OPORD).
- Service support instructions, any special equipment needed, regrouping of transport, or preliminary unit movements.

## FRAGMENTARY ORDERS

G-20. A *fragmentary order* is an abbreviated form of an operation order (verbal, written, or digital) usually issued on a day-to-day basis that eliminates the need for restating information contained in a basic operation order. It may be issued in sections. It is issued after an operation order to change or modify that order or to execute a branch or sequel to that order (JP 1-02). FRAGOs include all five OPORD paragraph headings (see Figure G-8). After each heading, state either new information or "no change." This ensures that recipients know they have received the entire FRAGO. Commanders may authorize members of their staff to issue FRAGOs in their name.

G-21. FRAGOs differ from OPORDs only in the degree of detail provided. They address only those parts of the original OPORD that have changed. FRAGOs

refer to previous orders and provide brief and specific instructions. The higher headquarters issues a new OPOD when there is a complete change of the tactical situation or when many changes make the current order ineffective.

## TECHNIQUES FOR ISSUING ORDERS

G-22. There are several techniques for issuing orders: verbal, written, or electronically produced using matrices or overlays. The five-paragraph format is the standard for issuing combat orders. Orders may be generated and disseminated by electronic means to reduce the amount of time needed to gather and brief the orders group. When available preparation time or resources are constrained, commanders may use the matrix method of issuing orders.

### VERBAL ORDERS

G-23. Verbal orders are used when operating in an extremely time-constrained environment. They offer the advantage of being passed quickly, but risk important information being overlooked or misunderstood. Verbal orders are usually followed up by written FRAGOs.

### GRAPHICS

G-24. Plans and orders generally include both text and graphics. Graphics convey information and instructions through military symbols (see FM 1-02). They complement the written portion of a plan or an order and promote clarity, accuracy, and brevity. The Army prefers depicting information and instructions graphically when possible. However, the mission statement and the commander's intent are always in writing.

### OVERLAYS

G-25. An overlay graphically portrays the location, size, and activity (past, current, or planned) of depicted units more consistently and accurately than text alone. An overlay enhances a viewer's ability to analyze the relationships of units and terrain. A trained viewer can attain a vision of a situation as well as insight into the identification of implied tasks, relationships, and coordination requirements that the written plan or order may not list or readily explain. Overlay graphics may be used on stand-alone overlays or overprinted maps. The issuing headquarters is responsible for the accuracy of control measures and for transposing graphics to and from the map scale used by subordinate headquarters (see Figures G-10 and G-29).

### OVERLAY ORDERS

G-26. An **overlay order** is a technique used to issue an order (normally a FRAGO) that has abbreviated instructions written on an overlay. Overlay orders combine a five-paragraph order with an operation overlay. Commanders may issue an overlay order when planning and preparation time is severely constrained and they must get the order to subordinate commanders as soon as possible. Commanders issue overlay orders by any suitable graphic method. An overlay order may consist of more than one overlay. A separate overlay or written annex can contain the service support coordination and organizations (see Figures G-9 and G-10).

## ADMINISTRATIVE INSTRUCTIONS FOR PREPARING PLANS AND ORDERS

G-27. Unless otherwise stated, the term order refers to both plans and orders. The following information pertains to administrative instructions for preparing all plans and orders.

### GENERAL INFORMATION

G-28. Show all paragraph headings on written orders. There is no need to place an entry under each heading except for Mission (paragraph 2) and Intent (paragraph 3). A paragraph heading with no text will state: “None” or “See [attachment type] [attachment letter or number].” In this context, **attachment is a collective term for annex, appendix, tab, and enclosure** (see paragraph G-51).

### ABBREVIATIONS

G-29. Use abbreviations to save time and space if they do not cause confusion. Do not sacrifice clarity for brevity. Keep abbreviations consistent throughout any order and its attachments. Avoid using abbreviations other than those contained in international agreements in joint and multinational communications (see AR 310-50 and FM 1-02).

### PLACE AND DIRECTION DESIGNATIONS

G-30. Describe locations or points on the ground by—

- Referring to military grid reference system (MGRS) coordinates.
- Referring to longitude and latitude if the maps available do not have the MGRS.
- Giving the distance and direction from a simple reference point: for example, “crossroads 1,000 meters southwest of church tower of NAPIERVILLE, LB6448.”

G-31. Designate directions in one of three ways:

- By using two locations or places: for example, direction ECKENTAL PV6690–PEGNITZ PA6851.
- As a point of the compass: for example, north or northeast.
- As a magnetic, grid, or true bearing, stating the unit of measure: for example, 85 degrees (magnetic).

G-32. When a place or feature on a map is mentioned for the first time, print the name in capital letters exactly as spelled on the map, and show its grid coordinates in parenthesis after it. When a control measure, such as a contact point, is used for the first time, print the name or designation of the point followed by its grid coordinates in parenthesis. Use four-, six-, or eight-digit MGRS coordinates (as necessary to precisely locate the place, feature, or point) preceded by the 100-kilometer square designation (for example, LB6448). Thereafter, repeat the coordinates only for clarity; use names, planning names, or codes.

G-33. Describe areas by naming the northernmost (12 o'clock) point first and the remaining points in clockwise order. Describe positions from left to right and

from front to rear, facing the enemy. To avoid confusion, identify flanks by compass points, rather than right or left of the friendly force.

G-34. If the possibility of confusion exists when describing a route, add compass points for clarity: for example, “The route is northwest along the road LAPRAIRIE–DELSON.” If a particular route already has a planning name, such as main supply route (MSR) LAME DOG, refer to the route using only that designator.

G-35. Designate trails, roads, and railroads by the names of places along them or with grid coordinates. Precede place names with *trail*, *road*, or *railroad*: for example, “road GRANT–CODY.” Designate the route for a movement by listing a sequence of grids from the start point to the release point. Otherwise, list the sequence of points from left to right or front to rear, facing the enemy.

G-36. Identify riverbanks as north, south, east, or west. In river crossing operations, identify riverbanks as either near or far.

G-37. Describe boundaries and phase lines by terrain features easily distinguishable from the ground or air, or on a map. When designating boundaries between units, state which unit has responsibility and authority for the place, feature, or location to which the description refers. State each location along a boundary as either inclusive or exclusive to a unit: for example, “1st Brigade, exclusive crossroad LB621352.” List boundaries and phase lines from left to right or front to rear, facing the enemy.

## NAMING CONVENTIONS

G-38. Unit SOPs normally designate naming conventions for graphics. Otherwise, planners select them. For clarity, avoid multiword names, such as “Junction City.” Simple names are better than complex ones. To ensure operations security, avoid assigning names that could reveal unit identities, such as the commander’s name or the unit’s home station. Do not name sequential phase lines and objectives in alphabetical order. For memory aids, use sets of names designated by the type of control measure or subordinate unit. For example, the division might use colors for objective names and minerals for phase line names.

## CLASSIFICATION MARKINGS

G-39. AR 380-5 contains a detailed description of marking, transmitting procedures, and other classification instructions. Place classification markings at the top and bottom of each page. All paragraphs must have the appropriate classification marking immediately following the numbered designation of the paragraph (preceding the first word if the paragraph is not numbered). If the entire plan or order is unclassified, no classification markings are required. Mark unclassified instructional or training material representing orders, “[Classification Level] For Training – Otherwise Unclassified.” Handle material marked classified for training only as classified material until the end of the exercise (see AR 380-5).

G-40. When the issuing headquarters sends classified plans or annexes separately, it assigns copy numbers to each and keeps a record of the copies sent to each addressee.

## EXPRESSING UNNAMED DATES AND TIMES

G-41. Use the following letters to designate unnamed dates and times in plans and orders (these are joint definitions):

- **C-day.** The unnamed day on which a deployment operation commences or is to commence. The deployment may be movement of troops, cargo, weapon systems, or a combination of these elements using any or all types of transport. The letter "C" will be the only one used to denote the above. The highest command or headquarters responsible for coordinating the planning will specify the exact meaning of C-day within the aforementioned definition. The command or headquarters directly responsible for the execution of the operation, if other than the one coordinating the planning, will do so in light of the meaning specified by the highest command or headquarters coordinating the planning (JP 1-02).
- **D-day.** The unnamed day on which a particular operation commences or is to commence (JP 1-02). The highest headquarters planning an operation specifies the exact meaning of D-day.
- **M-day.** The unnamed day on which full mobilization commences or is due to commence (JP 1-02).
- **N-day.** The unnamed day an active duty unit is notified for deployment or redeployment (JP 1-02).
- **R-day.** Redeployment day. The day on which redeployment of major combat, combat support, and combat service support forces begins in an operation (JP 1-02).
- **S-day.** The day the President authorized selective reserve call up (not more than 200,000) (JP 1-02).
- **T-day.** The effective day coincident with presidential declaration of national emergency and authorization of partial mobilization (not more than 1,000,000 personnel exclusive of the 200,000 call up) (JP 1-02).
- **W-day.** Declared by the National Command Authorities (president or secretary of defense), W-day is associated with an adversary decision to prepare for war (unambiguous strategic warning) (JP 1-02).
- **H-hour.** The specific hour on D-day at which a particular operation commences (JP 1-02). H-hour may also be the hour at which an OPLAN/OPORD is executed or is to be executed (as distinguished from the hour the order is issued. The highest command or headquarters coordinating planning specifies the exact meaning of H-hour within the above definition. When several operations or phases of an operation are being executed in the same area on D-day and confusion may arise over the use of the same hour designation, the letters F, L, S, W, and Y may be used.
- **L-hour.** The specific hour on C-day at which a deployment operation commences or is to commence (JP 1-02). For amphibious operations, L-hour is the time at which the first helicopter of the airborne assault wave touches down in the landing zone.

G-42. C-, D-, and M-days end at 2400 hours Universal Time (ZULU time). They are assumed to be 24 hours long for planning. Plans and orders state the letters used and their meanings. If a plan mentions more than one event, refer to the



secondary event in terms of the time of the primary event. Refer to days preceding or following C-, D-, or M-day by using a plus or minus sign and an Arabic number after the letter: for example, D – 3 is three days before D-day; D + 7 is seven days after D-day. When using a time element other than days, spell it out: for example, D + 3 months.

G-43. Refer to hours preceding or following (H- or L-hour) by a plus or minus sign and an Arabic number after the letter: for example, H – 3 is three hours before H-hour; H + 7 is seven hours after H-hour. When using a time element other than hours, spell it out: for example, H + 30 minutes.

G-44. Where it is necessary to identify a particular operation or exercise, place a nickname or code words before the letter; for example, BALD EAGLE (D-day) or ANVIL EXPRESS (M-day).

## **EXPRESSING TIME**

G-45. The effective time for implementing the plan or order is the same as the date-time group of the order. Express the date and time as a six-digit date-time group. The first two digits indicate the day of the month; the last four digits indicate the time. Add the month or the month and year to the date-time group when necessary to avoid confusion. For example, a complete date-time group appears as 060140Z August 20XX.

G-46. If the effective time of any portion of the order differs from that of the order, identify those portions at the beginning of the coordinating instructions (in paragraph 3): for example, “Effective only for planning on receipt,” or “Task organization effective 261300Z May 20XX.”

G-47. Express all times in a plan or order in terms of one time zone, for example ZULU (Z) or LOCAL (L) . Include the appropriate time zone indicator in the heading data and mission statement. For example, the time zone indicator for Central Standard Time in the continental US is SIERRA. When daylight savings time is in effect, the time zone indicator for Central Time is ROMEO. The relationship of local time to ZULU time, not the geographic location, determines the time zone indicator to use.

G-48. Express dates in the sequence day, month, and year (6 August 20XX). When using inclusive dates, express them by stating both dates separated by a dash (6–9 August 20XX or 6 August–6 September 20XX). Express times in the 24-hour clock system by means of four-digit Arabic numbers. Include the time zone indicator.

## **IDENTIFYING PAGES**

G-49. Identify pages following the first page of plans and orders with a short title identification heading. Include the number (or letter) designation of the plan or order, and the issuing headquarters: for example, OPLAN 00-7—23d AD (base plan identification) or ANNEX B (INTELLIGENCE) to OPLAN 00-15—23d AD (annex identification).

## NUMBERING PAGES

G-50. Use the following convention to indicate page numbers:

- Number the pages of the base order and each attachment separately, beginning on the first page of each attachment. Use a combination of alphanumeric designations to identify each attachment, as described below.
- Use Arabic numbers only to indicate page numbers. Place page numbers after the alphanumeric designation that identifies the attachment. (Use Arabic numbers without any preceding alphanumeric designation for base order page numbers.)
- Assign each attachment either a letter or Roman numeral that corresponds to the letter or number in the attachment's short title. Assign letters to annexes, Roman numbers to appendixes, letters to tabs, and Roman numbers to enclosures. Use Roman numbers only as elements of page numbers; do not use Roman numbers in attachment short titles.
- Separate elements of the alphanumeric designation with hyphens.

For example, the designation of the third page of enclosure 7 to Tab B to Appendix 2 to Annex A is A-II-B-VII-3.

## ATTACHMENTS (ANNEXES, APPENDIXES, TABS, AND ENCLOSURES)

G-51. Attachments (annexes, appendixes, tabs, and enclosures) are an information management tool. They simplify orders by providing a structure for organizing information. The staff member with responsibility for the functional area addressed in the attachment prepares it.

G-52. Attachments contain details not readily incorporated into the base order or a higher-level attachment: appendixes contain information necessary to expand annexes; tabs expand appendixes; enclosures expand tabs. Prepare attachments in a form that best portrays the information: for example, text, a matrix, a trace, an overlay, an overprinted map, a sketch, a plan, a graph, or a table. Prepare text in the format at Figure G-11.

G-53. Attachments are part of an order. Using them increases the base order's clarity and usefulness by keeping it short. Attachments include combat support (CS), CSS, and administrative details and instructions that amplify the base order. They may also contain branches and sequels.

G-54. The number and type of attachments depend on the commander, level of command, needs of the particular operation, and complexity of the functional area addressed. Minimize the number of attachments to keep consistent with completeness and clarity. If the information relating to an attachment's subject is brief enough to be placed in the base order or the higher-level attachment, place it there and omit the attachment.

G-55. List attachments under an appropriate heading at the end of the document they expand: for example, list annexes at the end of the base order, appendixes at the end of annexes, and so forth. Figure G-3 shows the required sequence of attachments. When local commands require attachments not listed in Figure G-3, label them beginning with the alphanumeric following the last one listed

under the appropriate higher level attachment: for example, using Figure G-3 as a reference—

- Additional annexes begin with the letter S.
- Additional appendixes to Annex P begin with Appendix 6.
- Additional tabs to Appendix 2 to Annex I begin with Tab D.

When an attachment required by doctrine or SOP is not necessary, indicate this by stating, “[Type of attachment and its alphanumeric identifier] omitted”; for example, “Annex E omitted.”

G-56. Refer to attachments by letter or number, and title. Use the following convention:

- **Annexes.** Designate annexes with capital letters: for example, Annex I (Service Support) to OPOD 02-06—52d ID (Mech).
- **Appendixes.** Designate appendixes with Arabic numbers: for example, Appendix 3 (Traffic Circulation and Control) to Annex I (Service Support) to OPOD 02-06—52d ID (Mech).
- **Tabs.** Designate tabs with capital letters: for example, Tab B (Road Movement Table) to Appendix 3 (Traffic Circulation and Control) to Annex I (Service Support) to OPOD 02-06—52d ID (Mech).
- **Enclosures.** Designate enclosures with Arabic numbers; for example, enclosure 2 (Route RED Overlay) to Tab B (Road Movement Table) to Appendix 3 (Traffic Circulation and Control) to Annex I (Service Support) to OPOD 02-06—52d ID (Mech).

G-57. Avoid creating attachments below the level of enclosure. When these are necessary, identify them by repeating the procedures for tabs and enclosures. Use double letters (AA) for attachments to enclosures. Use hyphenated double numbers (1-1) for attachments two levels below enclosures: for example, enclosure 2-1 ([title]) to Tab BB ([title]) to enclosure 2 (Route RED Overlay) to tab B (Road Movement Table) to Appendix 2 (Traffic Circulation and Control) to Annex I (Service Support) to OPOD 02-06—52d ID (Mech).

G-58. If an attachment has wider distribution than the base order, or is issued separately, the attachment requires a complete heading and acknowledgment instructions (see Figure G-11). When attachments are distributed with the base order, these elements are not required.

## STANDING OPERATING PROCEDURES

G-59. To enhance effectiveness and flexibility, commanders standardize routine or recurring actions not needing their personal involvement. SOPs detail how forces execute these unit-specific techniques and procedures. Commanders develop SOPs from doctrinal sources, applicable portions of higher headquarters procedures, the higher commander’s guidance, and experience. They are as complete as possible. SOPs allow new arrivals or newly attached units to quickly become familiar with the unit’s routine. SOPs apply until commanders change them. The benefits of SOPs include—

- Simplified, brief combat orders.
- Enhanced understanding and teamwork among commanders, staffs, and troops.
- Standard synchronized staff drills.

- Standard abbreviated or accelerated decision-making techniques.

G-60. The operations officer holds staff responsibility for tactical and administrative SOPs. This includes preparing, coordinating, authenticating, publishing, and distributing them. Other staff sections provide input.

## MATRICES AND TEMPLATES

G-61. A number of staff tools exist to support the commander and his staff in the decision-making process and the development of the order. Tools include the decision support template (DST), synchronization matrix, and execution matrix. However, matrices and templates are only tools; they are not orders.

### DECISION SUPPORT TEMPLATE

G-62. The decision support template is created by the staff during the decision-making process. **A *decision support template* is a staff product initially used in the war-gaming process that graphically represents the decision points and projected situations and indicates when, where, and under what conditions a decision is most likely to be required to initiate a specific activity or event. A DST contains time phase lines, named areas of interest (NAIs), targeted areas of interest (TAIs), and decision points.** (FM 34-100 details how to develop a DST.)

G-63. Part of the decision support template is the decision support matrix. **The *decision support matrix* is an aid used by the commander and staff to make battlefield decisions. This matrix is a staff product of the war-gaming process that lists the decision point, location of the decision point, the criteria to be evaluated at the point of decision, the action or operations to occur at the decision point, and the unit or element that is to act and has responsibility to observe and report the information affecting the criteria for the decision.**

### Time Phase Lines

G-64. *Time phase lines* (TPLs) are lines used to represent the movement of forces or the flow of an operation over time (FM 34-100), for example, in two-hour intervals. TPLs account for the effects of the battlefield environment and the anticipated effects of contact with other forces. For example, TPLs depicting threat movement through an area occupied by friendly forces use movement rates based on a force in contact with the enemy rather than convoy movement speeds.

G-65. TPLs help track enemy movements. They provide a graphic means of comparing the enemy's rate of movement along different avenues of approach and mobility corridors. TPLs can be computed for all types of enemy movement and operations; for example, air assault, deliberate attack, and dismounted infiltration. Both friendly and enemy movement rates are adjusted to compensate for the effects of weather, terrain, and obstacles. During operations, the intelligence officer adjusts TPLs to conform to the enemy's actual movement rates.

### Named Areas of Interest

G-66. A *named area of interest* is a geographical area where information that will satisfy a specific information requirement can be collected (FM 3-90). NAIs are usually selected to capture indications of enemy courses of action (COAs), but may also be related to battlefield and environment conditions. They can be points on the ground, a portion of a route, or a larger area. When possible, NAIs are placed in numbered sequences along an avenue of approach or a mobility corridor. This technique helps calculate movement times between NAIs. It also limits confusion about the avenue or corridor involved. An NAI may be designated a TAI when enemy activity is detected within it.

### Targeted Areas of Interest

G-67. A *targeted area of interest* is the geographical area or point along a mobility corridor where successful interdiction causes the enemy to abandon a particular course of action or requires him to use specialized engineer support to continue. It is where he can be acquired and engaged by friendly forces (FM 3-90). This engagement can be by maneuver, fires, obstacles, or electronic warfare. Commanders may suggest TAIs where they believe they can best attack high-payoff targets. The staff develops TAIs during the targeting process, based on the IPB (see Annex H). They refine TAIs during the war game. The commander approves TAIs during COA approval.

### Decision Points

G-68. A *decision point* is a point in space and time where the commander or staff anticipates making a decision concerning a specific friendly course of action. A decision point is usually associated with a specific targeted area of interest, and is located in time and space to permit the commander sufficient lead-time to engage the adversary in the targeted area of interest. Decision points may also be associated with the friendly force and the status of ongoing operations (JP 1-02).

G-69. Decision points (DPs) may be events or geographic areas. They address projected situations and indicate when, where, and under what conditions a decision is most likely to be required. A decision may be to initiate a specific activity (such as a branch or sequel) or event (such as lifting or shifting of fires). Decision points do not dictate decisions; they only indicate that a decision is anticipated, and when and where the decision should be made to have the maximum effect on friendly or enemy COAs. However, if the commander does not make a decision before the enemy force passes the DP, the force may not be able to take advantage of opportunities associated with that DP.

G-70. Factors affecting DP placement include the time required—

- For the intelligence officer to receive information from ISR assets focused on NAIs associated with the DP.
- To process or analyze information the commander requires to make the decision associated with the DP.
- To advise the commander of the activity.
- To disseminate orders or instructions to the proper maneuver, fire support, CS, or CSS unit or asset.
- For the unit or asset to execute the orders or instructions.

G-71. DPs are supported by one or more CCIR, which are then related to the appropriate number of NAIs in order to answer the question. NAIs associated with a DP are areas where ISR assets are focused to collect information the commander needs to make the decision associated with that DP.

G-72. DPs often trigger maneuver, fires, or effects on a TAI. For some TAIs, the commander specifies one attack option, thus one DP. However, commanders may designate a group of DPs, called a DP cluster, to address several options for one TAI.

### SYNCHRONIZATION MATRIX

G-73. **The *synchronization matrix* is a format for the staff to record the results of war gaming and used to synchronize a course of action (COA) across time, space, and purpose in relation to an enemy's COA.** Once the commander selects a COA, the staff uses the synchronization matrix to write the OPORD/OPLAN. Each battlefield operating system can develop its own synchronization matrix for more detail on specific tasks. The matrix clearly shows the relationships between activities, units, support functions, and key events. The synchronization matrix supports the staff in adjusting activities based on the commander's guidance and intent and the enemy's most likely COA. The synchronization matrix is not a formal part of plans and orders. It serves as a planning tool, an internal staff product, which normally is not distributed formally to subordinate and higher headquarters (see Chapter 3).

G-74. When used together, the synchronization matrix and the DST form a powerful graphic C2 tool. Once a decision is made on the COA, the staff can use the DST and synchronization matrix to assist in writing the OPLAN or OPORD. Because missions and decisions are laid out in a logical and orderly fashion, this is also a good way to ensure nothing is left out of the OPLAN or OPORD.

### EXECUTION MATRIX

G-75. **An *execution matrix* is a visual and sequential representation of the critical tasks and responsible organizations by time or for a tactical operation used as a staff tool.** The staff can write an annex to the OPLAN or OPORD as an execution matrix. An execution matrix could be for the entire force such as an Air Assault Execution Matrix, or may be BOS or functional specific such as a Fire Support Executing Matrix.

### EXAMPLES AND PROCEDURES FOR COMPLETING PLANS, ORDERS, AND ANNEXES

G-76. All plans, orders, and attachments use the five-paragraph format. Use the annotated annex format (Figure G-4) as a guide. Refer to individual annex examples for functional-area specifics. Figure G-1 contains the list of figures. Formats for joint plans and orders are described in CJCSM 3122.03A.

G-1. List of Figures .....	G-17
G-2. OPLAN/OPORD Outline Format.....	G-18
G-3. Sequence of Annexes and Appendixes to OPLANS/OPORDs.....	G-20
G-4. Annotated OPLAN/OPORD Format.....	G-21
G-5. Annotated Service Support Plan/Service Support Order Format.....	G-28
G-6. Movement Order Format.....	G-35
G-7. Warning Order Format.....	G-37
G-8. Fragmentary Order Format .....	G-39
G-9. Overlay Order Format .....	G-40
G-10. Overlay Order Example .....	G-42
G-11. Attachment Format (General) .....	G-44
G-12. Annex B (Intelligence) Instructions and Format .....	G-47
G-13. Annex C (Operation Overlay) Instructions and Format.....	G-49
G-14. Annex D (Fire Support) Instructions and Format .....	G-50
G-15. Annex E (Rules of Engagement) Instructions and Format.....	G-53
G-16. Annex F (Engineer) Instructions and Format.....	G-54
G-17. Annex G (Air and Missile Defense) Instructions and Format.....	G-57
G-18. Annex H (Command, Control, Communication, and Computer Operations) Instructions and Format .....	G-59
G-19. Annex I (Service Support) Instructions and Format.....	G-61
G-20. Annex J (Nuclear, Biological, and Chemical Operations) Instructions and Format.....	G-64
G-21. Annex K (Provost Marshal) Instructions and Format .....	G-66
G-22. Annex L (Intelligence, Surveillance, and Reconnaissance) Instructions and Format.....	G-68
G-23. Annex M (Rear Area and Base Security) Instructions and Format.....	G-73
G-24. Annex N (Space) Instructions and Format.....	G-75
G-25. Annex O (Army Airspace Command and Control) Instructions and Format .....	G-78
G-26. Annex P (Information Operations) Instructions and Format.....	G-79
G-27. Annex Q (Civil-Military Operations) Instructions and Format.....	G-83
G-28. Annex R (Public Affairs) Instructions and Format.....	G-85
G-29. Overlay to VII Corps Field Order 18, 23 March 1945.....	G-87
G-30 VII Corps Field Order 18, 23 March 1945.....	G-88

**NOTE:** Conventions such as the bold font and changes in the font size appearing in the headings of annotated formats are solely for emphasis within this manual. Boldface paragraph numbers, letters, and titles denote normal paragraph headings. Bullet lists indicate suggestions of the kinds of items that may go in subparagraphs. These conventions are solely for emphasis within this manual.

Figure G-1. List of Figures

<b>[Classification]</b> <b>[Change from verbal orders, if any]</b>	<b>Copy ## of ## copies</b> <b>Issuing headquarters</b> <b>Place of issue</b> <b>Date-time group of signature</b> <b>Message reference number</b>
<b>OPERATION PLAN/ORDER [number] [code name]</b>	
<b>References</b>	
<b>Time Zone Used Throughout the OPLAN/OPORD:</b>	
<b>Task Organization</b>	
<b>1. SITUATION.</b>	
<b>a. Enemy forces.</b>	
<b>b. Friendly forces.</b>	
<b>c. Environment</b>	
<b>(1). Terrain.</b>	
<b>(2). Weather.</b>	
<b>(3). Civil Considerations.</b>	
<b>d. Attachments and detachments.</b>	
<b>e. Assumptions.</b>	
<b>2. MISSION.</b>	
<b>3. EXECUTION.</b>	
<b>Intent:</b>	
<b>a. Concept of operations.</b>	
<b>(1) Maneuver.</b>	
<b>(2) Fires.</b>	
<b>(3) Intelligence, Surveillance, and Reconnaissance.</b>	
<b>(4) Intelligence.</b>	
<b>(5) Engineer.</b>	
<b>(6) Air and Missile Defense.</b>	
<b>(7) Information Operations.</b>	
<b>(8). Nuclear, Biological, Chemical.</b>	
<b>(9). Military Police.</b>	
<b>(10) Civil-Military Operations.</b>	
<b>b. Tasks to maneuver units.</b>	
<b>c. Tasks to other combat and combat support units.</b>	
<b>d. Coordinating instructions.</b>	
<b>(1) Time or condition when the plan/order becomes effective.</b>	
<b>(2) CCIR (PIR, FFIR).</b>	
<b>(3) Risk reduction control measures.</b>	
<b>(4) Rules of engagement.</b>	
<b>(5) Environmental considerations.</b>	
<b>(6) Force protection.</b>	
<b>(7) As required.</b>	
<b>4. SERVICE SUPPORT (Support Concept).</b>	
<b>[Classification]</b>	

Figure G-2. OPLAN/OPORD Outline Format



**[Classification]**

**OPLAN/OPORD [number] [code name]—[issuing headquarters]**

- b. Materiel and services.**
- c. Health service support.**
- d. Personnel.**
- e. As required.**

**5. COMMAND AND SIGNAL.**

- a. Command.**
- b. Signal.**

**ACKNOWLEDGE:**

**[Commander's last name]**  
**[Commander's rank]**

**OFFICIAL:**

**[Authenticator's Name]**  
**[Authenticator's Position]**

**ANNEXES:**

**DISTRIBUTION:**

**[Classification]**

Figure G-2. OPLAN/OPORD Outline Format (continued)

<p><b>Annex A (Task Organization)</b></p> <p><b>Annex B (Intelligence)</b></p> <p>    <b>Appendix 1 (Intelligence Estimate)</b></p> <p>    <b>Appendix 2 (Intelligence Synchronization Plan)</b></p> <p>    <b>Appendix 3 (Counterintelligence)</b></p> <p>    <b>Appendix 4 (IPB Products)</b></p> <p>    <b>Appendix 5 (Weather)</b></p> <p><b>Annex C (Operation Overlay)</b></p> <p><b>Annex D (Fire Support)</b></p> <p>    <b>Appendix 1 (Air Support)</b></p> <p>    <b>Appendix 2 (Field Artillery Support)</b></p> <p>    <b>Appendix 3 (Naval Gunfire Support)</b></p> <p><b>Annex E (Rules of Engagement)</b></p> <p>    <b>Appendix 1 (ROE Card)</b></p> <p><b>Annex F (Engineer)</b></p> <p>    <b>Appendix 1 (Obstacle Overlay)</b></p> <p>    <b>Appendix 2 (Environmental Considerations)</b></p> <p>    <b>Appendix 3 (Terrain)</b></p> <p>    <b>Appendix 4 (Mobility/Counter-mobility/Survivability Execution Matrix and Timeline)</b></p> <p>    <b>Appendix 5 (Explosive Ordnance Disposal)</b></p> <p><b>Annex G (Air and Missile Defense)</b></p> <p><b>Annex H (Command, Control, Communication, and Computer Operations)</b></p> <p><b>Annex I (Service Support)</b></p> <p>    <b>Appendix 1 (Service Support Matrix)</b></p> <p>    <b>Appendix 2 (Service Support Overlay)</b></p> <p>    <b>Appendix 3 (Traffic Circulation and Control)</b></p> <p>    <b>Tab A (Traffic Circulation Overlay)</b></p> <p>    <b>Tab B (Road Movement Table)</b></p> <p>    <b>Tab C (Highway Regulation)</b></p> <p>    <b>Appendix 4 (Personnel)</b></p>	<p><b>Appendix 5 (Legal)</b></p> <p><b>Appendix 6 (Religious Support)</b></p> <p><b>Appendix 7 (Foreign and Host-Nation Support)</b></p> <p><b>Appendix 8 (Contracting Support)</b></p> <p><b>Appendix 9 (Reports)</b></p> <p><b>Annex J (Nuclear, Biological, and Chemical Operations)</b></p> <p><b>Annex K (Provost Marshal)</b></p> <p><b>Annex L (Intelligence, Surveillance, and Reconnaissance Operations)</b></p> <p>    <b>Appendix 1 (ISR Tasking Plan/Matrix.)</b></p> <p>    <b>Appendix 2 (ISR Overlay)</b></p> <p><b>Annex M (Rear Area and Base Security)</b></p> <p><b>Annex N (Space)</b></p> <p><b>Annex O (Army Airspace Command and Control)</b></p> <p><b>Annex P (Information Operations)</b></p> <p>    <b>Appendix 1 (OPSEC)</b></p> <p>    <b>Appendix 2 (PSYOP)</b></p> <p>    <b>Appendix 3 (Military Deception)</b></p> <p>    <b>Appendix 4 (Electronic Warfare)</b></p> <p>    <b>Appendix 5 (IO Execution Matrix)</b></p> <p><b>Annex Q (Civil-Military Operations)</b></p> <p><b>Annex R (Public Affairs)</b></p>
---	---

Figure G-3. Sequence of Annexes and Appendixes to OPLANs/OPORDs

**[Classification]**

Place the classification at the top and bottom of every page of the OPLAN/OPORD.

**(Change from verbal orders, if any)**

The phrases “No change from verbal orders” or “No change from verbal orders except paragraph #” are required. This statement is applicable only if the commander issues a verbal order.

**Copy ## of ## copies**  
**Issuing headquarters**  
**Show location of issuing headquarters.**  
**Place of issue**

Show the name of the town or place in capital letters, coordinates in parentheses, and the country in capital letters. You may encode both.

**Date-time group of signature**

The effective time for implementing the plan or order is the same as the date-time group of signature unless the coordinating instructions state otherwise. Use time zone ZULU (Z) unless the order states otherwise. When orders apply to units in different time zones, use ZULU time. When an OPLAN/OPORD does not specify the actual time to begin an operation, state that time in terms of an event or in terms of one of the times listed in paragraph G-41 (for example, 0400 hours Z, D + 3).

**Message reference number**

Message reference numbers are internal control numbers that the unit signal officer issues and assigns to all plans and orders. The unit SOP normally describes their allocation and use. Using this number allows an addressee to acknowledge receiving the message in the clear.

**OPERATION PLAN/ORDER [number] [code name]**

Plans and orders normally receive a code name and are numbered consecutively within a calendar year.

**References**

List the maps, charts, datum, or other related documents the unit needs to understand the OPLAN/OPORD. Do not list SOPs. Refer to maps using the map series number (and country or geographic area, if required), sheet number and name, edition, and scale, if required. Datum is the mathematical model of the earth used to calculate the coordinate on any map. Different nations use different datums for printing coordinates on their maps. The datum is usually printed in the marginal information of each map. A common datum is essential for accurate targeting.

**Time Zone Used Throughout the OPLAN/OPORD:**

The time zone used throughout the OPLAN/OPORD (including attachments) is the time zone applicable to the operation. Operations across several time zones use ZULU time.

**[Classification]**

Figure G-4. Annotated OPLAN/OPORD Format

<p><b>[Classification]</b></p> <p><b>OPLAN/OPORD [number] [code name]—[issuing headquarters] (Place the classification and short title of the OPLAN/OPORD at the top of the second and any subsequent pages of the base OPLAN/OPORD.)</b></p> <p><b>Task Organization:</b></p> <p>Describe the allocation of forces to support the concept of operations (see appendix F). Task organization may be placed in annex A if it is long or complicated.</p> <p><b>1. SITUATION.</b></p> <p style="padding-left: 20px;"><b>a. Enemy forces.</b> Express this information in terms of two enemy echelons below yours (for instance, corps address brigades; battalions address platoons). Describe the enemy’s most likely and most dangerous COAs. When possible, provide a sketch of the enemy COA with the written description. These sketches are appendixes to annex B (Intelligence). Include an assessment of terrorist activities directed against US government interests in the area of operation (AO). Refer to annex B (Intelligence) and other sources as required.</p> <p style="padding-left: 20px;"><b>b. Friendly forces.</b> List the mission, commander’s intent, and concept of operations for headquarters one and two levels up. Subparagraphs state the missions of flank units and other units whose actions have a significant effect on the issuing headquarters.</p> <p style="padding-left: 20px;"><b>c. Environment.</b></p> <p style="padding-left: 40px;"><b>(1). Terrain.</b> List all critical terrain aspects that would impact operations. Refer to appendix 3 (Terrain) to annex E (Engineer) as required.</p> <p style="padding-left: 40px;"><b>(2). Weather.</b> List all critical weather aspects that would impact operations. Refer to appendix 4 (Weather) to annex B (Intelligence) as required.</p> <p style="padding-left: 40px;"><b>(3). Civil considerations.</b> List all critical civil considerations that would impact operations. Refer to annex Q (Civil-Military Operations) as required.</p> <p style="padding-left: 20px;"><b>d. Attachments and detachments.</b> Do not repeat information already listed under Task Organization or in annex A (Task Organization). Try to put all information in the task organization and state, “See Task Organization” or “See annex A” here. Otherwise, list units that are attached or detached to the headquarters that issues the order. State when attachment or detachment is effective, if different from the effective time of the OPLAN/ OPORD (such as, on-order, or on commitment of the reserve). Use the term “remains attached” when units will be or have been attached for some time.</p> <p style="padding-left: 20px;"><b>e. Assumptions</b> (OPLAN only). List all assumptions.</p> <p><b>2. MISSION.</b> Enter the restated mission (see chapter 3). A mission statement contains no subparagraphs. The mission statement covers on-order missions.</p> <p><b>3. EXECUTION. Intent: State the commander’s intent (see chapter 3).</b></p> <p style="padding-left: 20px;"><b>a. Concept of operations.</b> The concept of operations describes how the commander sees the actions of subordinate units fitting together to accomplish the mission. As a minimum, the concept of operations includes the scheme of maneuver and concept of fires. The concept of operations expands the commander’s selected COA and expresses how each element of the force will cooperate. Where the commander’s intent focuses on the end state, the concept of operations focuses on the method used for the operation and synchronizes battlefield operating systems to translate vision and end state into action. Commanders ensure that their concept of operations is consistent with their intent and that of the next two higher commanders.</p> <p style="text-align: center;"><b>[Classification]</b></p>
--

**Figure G-4. Annotated OPLAN/OPORD Format (continued)**

**[Classification]****OPLAN/OPORD [number] [code name]—[issuing headquarters]**

The concept of operations may be a single paragraph, divided into two or more subparagraphs or, if unusually lengthy, prepared as a separate annex (annex C, Operations). The concept of operations addresses the decisive and shaping operations. It describes the overall form of maneuver, designates the main effort for each phase of the operation (if phases are used), and includes any be-prepared missions. The concept of operations is concise and understandable. The concept of operations describes—

- The employment of major maneuver elements in a scheme of maneuver.
- A plan of fire support or “scheme of fires” supporting the maneuver with fires.
- The integration of other major elements or systems within the operation. These include ISR, intelligence, engineer, and air defense assets.
- Any other details the commander considers appropriate to clarify the concept of operations and ensure unity of effort. If the integration and coordination are too lengthy for this paragraph, they are addressed in the appropriate annexes, which are referenced here.

When an operation involves two or more clearly distinct and separate phases, the concept of operations may be prepared in subparagraphs describing each phase. Designate phases as “Phase” followed by the appropriate Roman numeral, for example, Phase I. If the operation is phased, all paragraphs and sub-paragraphs of the base order, and all annexes must mirror the phasing established in the concept of operations.

If the operation overlay is the only annex referenced, show it after “a. Concept of Operations.” Place the commander’s intent and concept of operations statement on the overlay if the overlay does not accompany the OPLAN/OPORD.

**NOTE:** The number of subparagraphs, if any, depend on what the commander considers appropriate, the level of command, and the complexity of the operation. The following subparagraphs are examples of what may be required within the concept of operations.

**(1) Maneuver.** State the scheme of maneuver. Be sure this paragraph is consistent with the operation overlay. It must address the decisive and shaping operations, including security operations and the use of reserves, and specify the purpose of each. This paragraph and the operation overlay are complementary, each adding clarity to, rather than duplicating, the other. Do not duplicate information in unit subparagraphs and the coordinating instructions.

**(2) Fires.** Describe the scheme of fires. State which unit has priority of fires. Include the purpose of, priorities for, allocation of, and restrictions for fire support. Refer to annex D (Fire Support) and other annexes as required. A technique for writing the fires paragraph is to list essential fire support tasks using the task, purpose, method, and effect format. The fires paragraph must be concise, but specific enough to clearly state what fires are to accomplish in the operations. If annex D is not used, include the following subparagraphs:

**(a) Air support.** State allocation of close air support (CAS) sorties, air interdiction sorties (corps), and nominations (division). Show tactical air reconnaissance sorties here or in annex B (intelligence). Corps and echelons above corps include nuclear weapons target nominations.

**[Classification]**

**Figure G-4. Annotated OPLAN/OPORD Format (continued)**

**[Classification]**

**OPLAN/OPORD [number] [code name]—[issuing headquarters]**

**(b) Field artillery support.** Cover priorities such as counterfires or interdiction. State organization for combat. Include command and support relationships only if they are not clear in the task organization. Ensure that allocation of fires supports the concept of operations.

**(c) Naval gunfire support.**

**(d) Fire support coordinating measures.**

**(3) Intelligence, Surveillance, and Reconnaissance.** State the overall reconnaissance objective. Outline the ISR concept and how it ties in with the scheme of maneuver. Address how ISR assets are operating in relation to the rest of the force. Do not list ISR tasks to units here. Assign ISR tasks to units in paragraphs 3b, 3c, or 4. Refer to annex L (ISR) as required.

**(4) Intelligence.** Describe the intelligence system concept. State the priority of effort among situation development, targeting, and battle damage assessment (BDA). Describe the priority of support to units and the priority of counterintelligence effort. Refer to annex B (Intelligence) and annex L (ISR) as required.

**(5) Engineer.** State the overall concept of Engineer support. State what unit has priority of support. State in a logical sequence the key M/CM/S, general engineering, and geospatial tasks that when integrated with the scheme of maneuver and all other BOS will enable accomplishment of the mission and achieve the commander's intent. A technique for writing this paragraph is to list the essential mobility/countermobility/survivability tasks using the task, purpose, method, and effect format. Refer to annex F (Engineer) and other annexes as required.

**(6) Air and Missile Defense.** State overall concept of air and missile defense. Include considerations of potential Air Force counterair support and the contribution of dedicated air defense units. Establish priority of air defense for general support units. Provide air defense weapons status and warning status. Refer to annex G (Air Defense) and other annexes as required.

**(7) Information Operations.** State IO concept of support and list the IO objectives. Refer to annex P (Information Operations) and other annexes as required. Do not list IO tasks. Assign IO tasks to units in paragraphs 3b, 3c, or 4.

**(8) NBC Operations.** State the overall concept of NBC operations. Assign priorities of effort and support. Address functions or support roles of organic or attached chemical and smoke units if not clear in task organization. Establish priorities of work if not addressed in unit SOPs. Refer to annex J (NBC Operations) and other annexes as required.

**[Classification]**

Figure G-4. Annotated OPLAN/OPORD Format (continued)

**[Classification]****OPLAN/OPORD [number] [code name]—[issuing headquarters]**

**(9) Military Police Operations.** State the overall concept of military police operations in support of the scheme of maneuver. Assign priorities of effort and support. Address functions or support roles of organic or attached military police units if it is not clear in task organization. Establish priorities of support to EPW operations, circulation control plan, and rear area security if not addressed in unit SOPs. Refer to annex K (Provost Marshal) and other annexes as required.

**(10) Civil-Military Operations.** State the overall civil-military operation (CMO) concept. Assign priorities of effort and support. Refer to annex Q (CMO) and other annexes as required.

**b. Tasks to maneuver units.** State the missions or tasks assigned to each maneuver unit that reports directly to the headquarters issuing the order. Every task must include a purpose that links it to the concept of operations. Use a separate subparagraph for each unit. Cross-reference attachments that assign them tasks. List units in task organization sequence. Include reserves. State only tasks that are necessary for comprehension, clarity, and emphasis. Place tasks that affect two or more units in paragraph 3d, Coordinating Instructions.

**c. Tasks to other combat and combat support units.** State the missions or tasks assigned to nonmaneuver combat units and CS units. Cross-reference attachments that assign them tasks. Use a separate subparagraph for each unit. List units in task organization sequence. List only those tasks that are not specified or implied elsewhere.

**d. Coordinating instructions.** List only instructions applicable to two or more units and not covered in unit SOPs. This is always the last subparagraph in paragraph 3. Complex instructions should be placed in an annex. Paragraphs 3d(1)–d(5) below are mandatory.

**(1) Time or condition when a plan or an order becomes effective.**

**(2) Commander's critical information requirements.** List CCIR here. If CCIR is located in other annexes, ensure they are identical.

**(3) Risk reduction control measures.** These are measures unique to this operation and not included in unit SOPs. They may include mission-oriented protective posture, operational exposure guidance, troop-safety criteria (corps only), vehicle recognition signals, and fratricide prevention measures.

**(4) Rules of engagement (ROE).** Refer to annex E (ROE) if required.

**(5) Environmental considerations.**

**(6) Force protection.**

**(7) Any additional coordinating instructions.**

**[Classification]**

Figure G-4. Annotated OPLAN/OPORD Format (continued)

**[Classification]**

**OPLAN/OPORD [number] [code name]—[issuing headquarters]**

**4. SERVICE SUPPORT.** Address service support in the areas shown below as needed to clarify the service support concept. Refer to annexes, if required. A Service Support Plan/Service Support Order may replace this paragraph in division and corps orders (see figure G-5, page G-29) Subparagraphs can include the following:

**a. Support concept.** State the concept of logistics support to provide non-CSS commanders and their staffs a visualization of how the operation will be logistically supported. This could include—

- A brief synopsis of the support command mission.
- Support command headquarters or support area locations, including locations of the next higher logistic bases if not clearly conveyed in the CSS overlay.
- The next higher level’s support priorities and where the unit fits into those priorities.
- The commander’s priorities of support.
- Units in the next higher CSS organization supporting the unit.
- The use of host-nation support.
- Significant or unusual CSS issues that might impact the overall operation.
- Any significant sustainment risks.
- Unique support requirements in the functional areas of manning, arming, fueling, fixing, moving, and sustaining soldiers and their systems.
- The support concept organized into a framework based on operational phasing, or presented in the before-during-after-operations format.

**b. Materiel and services.**

**c. Health service support.**

**d. Personnel service support.**

**5. COMMAND AND SIGNAL.**

**a. Command.** State the map coordinates for command post locations and at least one future location for each command post. Identify the chain of command if not addressed in unit SOPs.

**b. Signal.** List signal instructions not specified in unit SOPs. Identify the specific signal operating instructions edition in effect, required reports and formats, and times the reports are submitted.

**ACKNOWLEDGE:** Include instructions for the acknowledgement of the plan or order by addressees. The word “acknowledge” may suffice or you may refer to the message reference number. Acknowledgement of a plan or order means that it has been received and understood.

**[Classification]**

Figure G-4. Annotated OPLAN/OPORD Format (continued)



<b>[Classification]</b>	
<b>OPLAN/OPORD [number] [code name]—[issuing headquarters]</b>	
<b>[Commander's last name]</b>	
<b>[Commander's rank]</b>	
<p>The commander or authorized representative signs the original copy. If the representative signs the original, add the phrase "For the Commander." The signed copy is the historical copy and remains in headquarters files.</p>	
<b>OFFICIAL:</b>	
<b>[Authenticator's Name]</b>	
<b>[Authenticator's Position]</b>	
<p>Use only if the commander does not sign the original order. If the commander signs the original, no further authentication is required. If the commander does not sign, the signature of the preparing staff officer requires authentication and only the last name and rank of the commander appear in the signature block.</p>	
<p><b>ANNEXES:</b> List annexes by letter and title in the sequence shown in figure G-3. If a particular annex is not used, place a "not used" beside that annex letter.</p>	
<p><b>DISTRIBUTION:</b> Furnish distribution copies either for action or for information. List in detail those who are to receive the plan or order. If necessary, also refer to an annex containing the distribution list or to a standard distribution list or SOP. When referring to a standard distribution list, also show distribution to reinforcing, supporting, and adjacent units, since that list does not normally include these units. When distribution includes a unit from another nation or from a NATO command, cite the distribution list in full.</p>	
<b>[Classification]</b>	

Figure G-4. Annotated OPLAN/OPORD Format (continued)

<b>[Classification]</b>
Place the classification at the top and bottom of every page of the Service Support Plan/Service Support Order.
<b>(Change from verbal orders, if any)</b>
The phrases “No change from verbal orders” or “No change from verbal orders except paragraph #” are required. This statement is only applicable if the commander issues a verbal order.
<b>Copy ## of ## copies Issuing headquarters</b>
Show location of issuing headquarters.
<b>Place of issue</b>
Show the name of the town or place in capital letters, coordinates in parentheses, and the country in capital letters. You may encode both.
<b>Date-time group of signature</b>
The effective time for implementing the plan or order is the same as the date-time group of signature unless the coordinating instructions state otherwise. Use time zone ZULU (Z) unless the order states otherwise. When orders apply to units in different time zones, use ZULU time. When an OPLAN/OPORD does not specify the actual time to begin an operation, state that time in terms of an event or in terms of one of the times listed in paragraph G-41 (for example, 0400 hours Z, D + 3).
<b>Message reference number</b>
Message reference numbers are internal control numbers that the unit signal officer issues and assigns to all plans and orders. The unit SOP normally describes their allocation and use. Using this number allows an addressee to acknowledge receiving the message in the clear.
<b>SERVICE SUPPORT PLAN/ORDER [number] [code name]</b>
Plans and orders normally contain a code name and are numbered consecutively within a calendar year.
<b>Related OPLAN/OPORD [number] [code name] (when applicable).</b>
<b>References</b>
List the maps, charts, datum, or other related documents the unit needs to understand the OPLAN/OPORD. Do not list SOPs. Refer to maps using the map series number (and country or geographic area, if required), sheet number and name, edition, and scale, if required. Datum is the mathematical model of the earth used to calculate the coordinate on any map. Different nations use different datums for printing coordinates on their maps. The datum is usually printed in the marginal information of each map. A common datum is essential for accurate targeting.
<b>[Classification]</b>

Figure G-5. Annotated Service Support Plan/Service Support Order Format

<p><b>[Classification]</b></p> <p><b>SERVICE SUPPORT PLAN/ SERVICE SUPPORT ORDER [number] [code name]— [issuing headquarters]</b></p> <p><b>Time Zone Used Throughout the OPLAN/OPORD:</b></p> <p>The time zone used throughout the OPLAN/OPORD (including attachments) is the time zone applicable to the operation. Operations across several time zones use ZULU time.</p> <p>Place the classification and short title of the OPLAN/OPORD at the top of the second and any subsequent pages of the base OPLAN/OPORD.</p> <p><b>Task Organization:</b> List the number and coordinates of CSS units here or in a trace or overlay. If you do not list units here, omit this heading.</p> <p><b>1. SITUATION.</b> State the general CSS factors affecting support of the operation. Include any information essential to understanding the current situation as it influences CSS. This information comes from paragraph 1 of the related OPLAN/OPORD.</p> <p><b>a. Enemy forces.</b> Refer to an OPLAN/OPORD or its intelligence annex if it has been published or is to be published. List information about the composition, disposition, location, movements, estimated strengths, and identifications of enemy forces. List enemy capabilities that could influence the CSS mission.</p> <p><b>b. Friendly forces.</b> List pertinent information concerning friendly forces (other than those a referenced OPLAN/OPORD covers or that subsequent paragraphs of this PLAN/order include) that might directly influence the CSS mission.</p> <p><b>c. Environment.</b></p> <p><b>(1) Terrain.</b> Refer to related OPLAN/OPORD or its engineer annex. List all critical terrain aspects that would impact CSS operations.</p> <p><b>(2) Weather.</b> Refer to related OPLAN/OPORD or its intelligence annex. List all critical weather aspects that would impact CSS operations.</p> <p><b>(3) Civil considerations.</b> Refer to related OPLAN/OPORD or its civil-military operations annex. List all critical civil considerations that would impact CSS operations.</p> <p><b>d. Attachments and detachments.</b> See related OPLAN/OPORD.</p> <p><b>e. Assumptions</b> (Service Support Plan only). Same as the related OPLAN/OPORD.</p> <p><b>2. MISSION.</b> State the CSS tasks and their purpose.</p> <p><b>3. EXECUTION.</b></p> <p><b>NOTE:</b> There is no commander's intent statement for a Service Support Plan/Service Support Order.</p> <p><b>Concept of support operations.</b> Outline the general plan for CSS and any instructions that succeeding paragraphs do not suitably cover (for example, location of the division support area, location of coordinating agencies, general instructions for movement of bases).</p> <p><b>4. SERVICE SUPPORT.</b></p> <p><b>a. Materiel and services.</b></p> <p><b>(1) Supply.</b> This paragraph contains a subparagraph for each class of supply, maps, water, special supplies, excess materiel, salvage materiel, and captured enemy materiel. Each subparagraph contains the location of the installations that handle supplies and materiel for supported units. They also contain the time of opening or closing, operating</p> <p style="text-align: center;"><b>[Classification]</b></p>
---

Figure G-5. Annotated Service Support Plan/ Service Support Order Format (continued)

<p><b>[Classification]</b></p> <p><b>SERVICE SUPPORT PLAN/ SERVICE SUPPORT ORDER [number] [code name]— [issuing headquarters]</b></p> <p>units, supported units, levels of supply, methods and schedules of distribution, and other instructions or information supported units need. Instructions or information for two or more classes of supply may be listed under one paragraph. However, do not sacrifice clarity. For Class V, include the designation and location of the approving agency for ammunition requisitions and the controlled supply rate, as appropriate.</p> <p><b>(2) Transportation.</b> Include location of terminals and installations (rail stations, airfields, and ports); operating units; schedules (march tables, timetables, and rail movement tables); area responsibilities of the transportation movement officers and highway regulating teams; traffic control and regulation measures, such as, regulations, restrictions, allocation priorities, and regulating and control points; and designation of the main supply routes. Modes may include ocean, inland waterway, coastal, highway, air, and rail. Include procedures to request transportation support.</p> <p><b>(3) Services.</b> Include information or instructions for support units that prescribe the type of service available, designation and location of the unit or installation providing the service, assignments to support units, and schedules for service, if applicable. Include specific missions for service units supporting operations. For example, include priority of effort for general engineering missions. Under each subparagraph, list pertinent service installations, stating location, operating units, and assignments to supported units. Assign any special missions not covered in other orders to service units. Divide this information into subparagraphs if necessary. The following are examples of subparagraphs under services:</p> <p><b>(a) Field services.</b> Include food preparation, water purification, aerial delivery, showers, laundry, clothing repair, light textile repair, and mortuary affairs. For mortuary affairs, establish locations of collection points, evacuation procedures, and handling of personal effects. Include procedures for emergency and temporary burials, mass burials, or contaminated remains.</p> <p><b>(b) Installation service.</b> List real estate, repair and utilities, fire protection, sewage and trash disposal, hazardous material and waste disposal, and water supply. Establish base camps to house soldiers.</p> <p><b>(c) Other.</b> Include any CSS requirements for EOD and contingency contracting.</p> <p><b>(4) Labor.</b> Include policies, with any restrictions, on using civilian internees or detainees and EPW in labor units. Allocate and prioritize available labor. Include designation and location of available labor units.</p> <p><b>(5) Maintenance.</b> Include priority of maintenance, location of facilities, collection points, maintenance time lines, and evacuation procedures.</p> <p><b>b. Health service support.</b> Include information and instructions for supported units. Prescribe the plan for collection, triage, medical evacuation, and medical treatment of</p> <p style="text-align: center;"><b>[Classification]</b></p>
---

**Figure G-5. Annotated Service Support Plan/ Service Support Order Format (continued)**

<p><b>[Classification]</b></p> <p><b>SERVICE SUPPORT PLAN/ SERVICE SUPPORT ORDER [number] [code name]— [issuing headquarters]</b></p> <p>sick, injured, and wounded soldiers, including EPW. List procedures to be used for civilian casualties and CBRNE events.</p> <p><b>(1) Evacuation.</b> List ambulance exchange points. Establish ambulance shuttles, routes, means, and schedules of evacuation; evacuation and en route treatment policies for the use of nonmedical transportation assets; policies for evacuation by air or ground; and evacuation of NBC-contaminated patients. Include information about MEDEVAC request procedures and channels, and evacuation or holding policies.</p> <p><b>(2) Treatment.</b> List of all appropriate treatment facilities (for example, dispensaries, aid stations, clearing stations, hospitals) belonging to or supporting the force. Include the location and operational time of supporting hospitals, medical regulating matters, and evacuation policy. Establish patient decontamination facilities.</p> <p><b>(3) Other services.</b> Include pertinent information on any other HSS matters (for example, dental, preventive medicine, health service logistics, combat operational stress control, veterinary services, and medical laboratory support). Include unit locations, support information, policies, requirements for nonmedical augmentation to accomplish patient decontamination, support requirements for providing nonmedical guards for EPW evacuated within CHS channels, and any other appropriate information.</p> <p><b>c. Personnel.</b></p> <p><b>(1) Personnel matters.</b> Include information and instructions on personnel matters, including US and third country national systems and contractor personnel who deploy with, and provide direct support to, Army forces in theater. List information under each of the following subparagraphs, when necessary.</p> <ul style="list-style-type: none"> <li>• Installations. Location and time of opening or closing.</li> <li>• Operating units. The units or areas served.</li> <li>• Rotation criteria.</li> <li>• Unit responsibility for personnel movement and administration.</li> <li>• Requisitions or plans concerning personnel activities.</li> <li>• A necessary reference to previous orders, instructions, or SOPs.</li> </ul> <p><b>(2) Strength maintenance.</b></p> <p><b>(a) Strength reports.</b> Include instructions for submitting strength reports. Include requirements for routine reports and special reports required after weapons of mass destruction attacks, natural disasters, and serious incidents.</p> <p><b>(b) Replacements.</b> Include a statement establishing the validity of existing personnel requisitions, instructions for submitting requisitions, instructions for processing and moving replacements, the location of replacement units along with units each supports, and the type and location of unit replacements under control of the issuing headquarters.</p> <p style="text-align: center;"><b>[Classification]</b></p>
---

Figure G-5. Annotated Service Support Plan/ Service Support Order Format (continued)

<p><b>[Classification]</b></p> <p><b>SERVICE SUPPORT PLAN/ SERVICE SUPPORT ORDER [number] [code name]— [issuing headquarters]</b></p> <p><b>(3) Casualty operations.</b> Include instructions for recording, reporting, verifying, and processing casualty information.</p> <p><b>(4) Personnel management.</b></p> <p><b>(a) Military personnel.</b> Include information or instructions concerning classification, assignment, promotion, transfer, reclassification, reduction, elimination, retirement, separation, training, rotation, stop loss/stop move, and personnel economies.</p> <p><b>(b) Civilian personnel.</b> List sources of civilian labor; locations of civilian personnel offices or other labor administration centers and labor pools; procurement policies and procedures; restrictions on use of civilian labor; administrative and control procedures; pay schedules, allowances, and CSS to be provided; and responsibilities of subordinate commanders for administration. Provide specific pay scales and other conditions of employment in an annex.</p> <p><b>(c) Enemy prisoners of war and civilian internees or detainees.</b> Include instructions for collecting, safeguarding, processing, evacuating, using, treating, and disciplining EPWs, civilian internees, detainees, and all other personnel arrested or captured but not immediately identifiable as EPWs. Include the location of EPW and civilian internee and detainee facilities.</p> <p><b>(5) Personnel service support.</b> Include information or instructions concerning leaves; rest and recreation facilities including criteria and unit quotas, decorations and awards, postal and finance services, chaplain activities and religious coverage, field services, morale support activities, post exchange, and legal assistance.</p> <p><b>(6) Discipline, law, and order.</b> Include information and instructions about troop conduct and appearance. Address control and disposition of stragglers, locations of straggler-collecting points, and special instructions for straggler-control augmentation. Include instructions for administering military justice and information or instructions concerning relations between military and civilian personnel: such as, fraternization, black-marketing, selling of government property, and respect for local laws.</p> <p><b>(7) Headquarters management.</b> Include instructions concerning movement, internal arrangement, organization, and operation of headquarters. Allocate shelter in the headquarters area for troops and headquarters personnel.</p> <p><b>(8) Miscellaneous.</b> Include personnel administrative matters not assigned to another coordinating staff section or included in the preceding subparagraphs.</p> <p><b>d. Third-nation support and host-nation support.</b> Outline the concept for third-nation support and host-nation support. Include forecasted and unforecasted support.</p> <p><b>e. Coordinating instructions.</b> List instructions applicable to two or more units and not routinely covered in unit SOPs. This is always the last subparagraph in paragraph 4.</p> <p style="text-align: center;"><b>[Classification]</b></p>
--

**Figure G-5. Annotated Service Support Plan/ Service Support Order Format (continued)**

**[Classification]**

Place complex instructions in an annex. Paragraphs 4e(1)–4e(4) are mandatory.

**(1) Time or condition when a plan or an order becomes effective.** Include the time or the conditions under which the plan is to be placed in effect.

**(2) Commander’s critical information requirements.** List only in coordinating instructions and not in annexes.

**(3) Risk reduction control measures.** These are measures unique to this operation and not included in unit SOPs. They may include mission-oriented protective posture, operational exposure guidance, troop-safety criteria (corps only), vehicle recognition signals, and fratricide prevention measures.

**(4) Rules of engagement.** Refer to annex E (ROE) if required.

**(5) Boundaries.** List location of the rear boundary and any other boundary needed for CSS purposes.

**(6) Force protection.** Address measures established to protect CSS units or installations. Specify which tactical units are to provide protection, which CSS units or installations will receive protection, and any conditioning factors to that protection. This paragraph provides information for CSS units; it is not an order to tactical units.

**(7) Special reports.** List reports requiring special emphasis that are not addressed elsewhere.

**(8) Other CSS matters.** Include information or instructions not addressed elsewhere.

**5. COMMAND AND SIGNAL.**

**a. Command.** State the map coordinates for command post (CP) locations and at least one future location for each CP. Identify the chain of command if not addressed in unit SOPs.

**b. Signal.** Refer to appropriate OPLAN/OPORD. When not included in the basic OPLAN/OPORD, include the headquarters location and movements, liaison arrangements, recognition and identification instructions, and general rules concerning the use of communications and other electronic equipment, if necessary. Use an annex when appropriate.

**ACKNOWLEDGE:** Include instructions for the acknowledgement of the plan or order by addressees. The word “acknowledge” may suffice or you may refer to the message reference number. Acknowledgement of a plan or order means that it has been received and understood.

The commander or authorized representative signs the original copy. If the representative signs the original, add the phrase “For the Commander.” The signed copy is the historical copy and remains in headquarters files.

**[Classification]**

**Figure G-5. Annotated Service Support Plan/ Service Support Order Format (continued)**

<p>[Classification]</p> <p><b>SERVICE SUPPORT PLAN/ORDER OPLAN/ SERVICE SUPPORT OPORD [number]</b> <b>[code name]—[issuing headquarters]</b></p> <p style="text-align: right;"><b>[Commander's last name]</b> <b>[Commander's rank]</b></p> <p><b>OFFICIAL:</b></p> <p><b>[Authenticator's Name]</b> <b>[Authenticator's Position]</b></p> <p>Use only if the commander does not sign the original order. If the commander signs the original, no further authentication is required. If the commander does not sign, the signature of the preparing staff officer requires authentication and only the last name and rank of the commander appear in the signature block.</p> <p><b>ANNEXES:</b> List annexes by letter and title in the sequence shown in figure G-3. If a particular annex is not used, state "Not Used" beside that annex letter.</p> <p><b>DISTRIBUTION:</b> Furnish distribution copies either for action or for information. List in detail those who are to receive the plan or order. If necessary, also refer to an annex containing the distribution list or to a standard distribution list or SOP. When referring to a standard distribution list, show distribution to reinforcing, supporting, and adjacent units, since that list does not normally include these units. When distribution includes a unit from another nation or from a NATO command, cite the distribution list in full.</p> <p style="text-align: center;">[Classification]</p>
--

Figure G-5. Annotated Service Support Plan/ Service Support OPORD Format (continued)



**[Classification]**  
(Change from verbal orders, if any)  
**[Heading data is the same as for OPLAN/OPORD]**

**MOVEMENT ORDER [number]**

**References:**

**Time Zone Used Throughout the Order:**

**Task Organization:**

- 1. SITUATION.**
  - a. Enemy forces.
  - b. Friendly forces.
  - c. Attachments and detachments.
- 2. MISSION.**
- 3. EXECUTION.**
  - a. Concept of movement.
  - b. Tasks to subordinate units.
  - c. Detailed timings.
  - d. Coordinating instructions.
    - (1) Order of March.
    - (2) Routes.
    - (3) Density.
    - (4) Speed. (Include catch-up speed.)
    - (5) Method of movement.
    - (6) Defense on move.
    - (7) Start, release, or other critical points.
    - (8) Convoy control.
    - (9) Harbor areas.
    - (10) Instructions for halts.
    - (11) Lighting.
    - (12) Air support.
- 4. SERVICE SUPPORT.**
  - a. Traffic control (performed by MPs).
  - b. Recovery.
  - c. Medical.
  - d. Petroleum, oils, and lubricants.
  - e. Water.

Figure G-6. Movement Order Format

**5. COMMAND AND SIGNAL.**

**a. Command.**

- (1) Location of commander and chain of command.
- (2) Locations of key individuals or particular vehicles.

**b. Signal.**

**ACKNOWLEDGE:**

[Authentication data is the same as for OPLAN/OPORD]

**ANNEXES:**

**DISTRIBUTION:**

[Classification]

**Figure G-6. Movement Order Format (continued)**

<p><b>[Classification]</b>  <b>(Change from verbal orders, if any) (Optional)</b>  <b>[Heading data is the same as for OPLAN/OPORD]</b></p>	
<p><b>WARNING ORDER [number]</b></p>	
<p><b>References:</b> Refer to higher headquarters OPLAN/OPORD, and identify map sheets for operation (Optional).</p>	
<p><b>Time Zone Used Throughout the Order:</b> (Optional)</p>	
<p><b>Task Organization:</b> (Optional) (See paragraph 1c.)</p>	
<p><b>1. SITUATION.</b></p>	
<p><b>a. Enemy forces.</b> Include significant changes in enemy composition, dispositions, and COAs. Information not available can be included in subsequent WARNOs.</p>	
<p><b>b. Friendly forces.</b> (Optional) Address only if essential to the WARNO.</p>	
<p>(1) Higher commander's mission.</p>	
<p>(2) Higher commander's intent.</p>	
<p><b>c. Environment.</b> (Optional) Address only if essential to the WARNO.</p>	
<p>(1). <b>Terrain.</b></p>	
<p>(2). <b>Weather.</b></p>	
<p>(3). <b>Civil considerations.</b></p>	
<p><b>Attachments and detachments.</b> Initial task organization. Address only major unit changes.</p>	
<p><b>2. MISSION.</b> Issuing headquarters' mission. This may be the higher headquarters' restated mission or commander's decisions during the MDMP.</p>	
<p><b>3. EXECUTION.</b></p>	
<p><b>Intent:</b></p>	
<p><b>a. Concept of operations.</b> This may be "to be determined" for the initial WARNO.</p>	
<p><b>b. Tasks to maneuver units.</b> Any information on tasks to units for execution, movement to initiate, reconnaissance to initiate, or security to emplace.</p>	
<p><b>c. Tasks to other combat and combat support units.</b> See paragraph 3b.</p>	
<p><b>d. Coordinating instructions.</b> Include any information available at the time of the issuance of the WARNO. It may include the following:</p>	
<ul style="list-style-type: none"> <li>• CCIR.</li> <li>• Risk guidance.</li> <li>• Time line.</li> <li>• Deception guidance.</li> <li>• Orders group meeting information.</li> <li>• Specific priorities, in order of completion.</li> <li>• Earliest movement time and degree of notice.</li> <li>• Guidance on orders and rehearsals.</li> </ul>	
<p><b>4. SERVICE SUPPORT.</b> (Optional) Include any known logistics preparations.</p>	
<p><b>a. Special equipment.</b> Identify requirements and coordinate transfer to using units.</p>	
<p><b>b. Transportation.</b> Identify requirements, and coordinate for pre-position of assets.</p>	

A warning order does not authorize execution unless specifically stated.

**Figure G-7. Warning Order Format**

**5. COMMAND AND SIGNAL.** (Optional)

**a. Command.** State the chain of command if different from unit SOP.

**b. Signal.** Identify the current SOI. Pre-position signal assets to support operation.

**ACKNOWLEDGE:**

[Authentication data is the same as for OPLAN/OPORD]

**ANNEXES:**

**DISTRIBUTION:**

[Classification]

Figure G-7. Warning Order Format (continued)

<b>[Classification]</b> (Change from verbal orders, if any)	<b>Copy ## of ## copies</b> <b>Issuing headquarters</b> <b>Place of issue</b> <b>Date-time group of signature</b> <b>Message reference number</b>
<b>FRAGMENTARY ORDER [number]</b>	
<b>References:</b> Refer to the order being modified.	
<b>Time Zone Used Throughout the Order:</b>	
<b>1. SITUATION.</b> Include any changes to the existing order or state, "No change"; for example, "No change to OPORD 02-XX."	
<b>2. MISSION.</b> List the new mission or state, "No change."	
<b>3. EXECUTION.</b> Include any changes or state, "No change."	
<b>Intent:</b>	
<b>a. Concept of operations.</b>	
<b>b. Tasks to subordinate units.</b>	
<b>c. Coordinating instructions.</b> Include statement, "Current overlay remains in effect" or "See change 1 to annex C, Operations Overlay." Mark changes to control measures on the overlay or issue a new overlay.	
<b>4. SERVICE SUPPORT.</b> Include any changes to existing order or state, "No change."	
<b>5. COMMAND AND SIGNAL.</b> Include any changes to existing order or state, "No change."	
<b>ACKNOWLEDGE:</b>	
	<b>[Commander's last name]</b> <b>[Commander's rank]</b>
<b>OFFICIAL:</b>	
<b>[Authenticator's Name]</b> <b>[Authenticator's Position]</b>	
<b>ANNEXES:</b>	
<b>DISTRIBUTION:</b>	
<b>[Classification]</b>	

Figure G-8. Fragmentary Order Format

<b>[Classification]</b> <b>(Change from verbal orders, if any)</b>	<b>Copy ## of ## copies</b> <b>Issuing headquarters</b> <b>Place of issue</b> <b>Date-time group of signature</b> <b>Message reference number</b>
<b>OVERLAY ORDER [number] [code name]</b>	
<b>References:</b>	
<b>Time Zone Used Throughout the Order:</b>	
<b>Task Organization:</b> List only changes on the overlay.	
<b>1. SITUATION.</b> Verbal brief, identifies any changes to enemy or friendly situation.	
<b>a. Enemy forces.</b> Verbal brief, referring to enemy unit locations (known or suspected) on the overlay.	
<b>b. Friendly forces.</b> Verbal brief, referring to friendly unit locations on the overlay.	
<b>c. Environment.</b> Verbal brief, referring to key terrain, weather aspects, and any civil considerations on overlay.	
<b>d. Attachments and detachments.</b> Verbal brief, confirming changes to the task organization.	
<b>d. Commander's evaluation.</b> Verbal brief.	
<b>2. MISSION.</b> Written on the overlay.	
<b>3. EXECUTION.</b>	
<b>Intent:</b>	
<b>a. Concept of operations.</b> Verbal brief, referring to the overlay. Focus on key events. Identify the main effort, priorities of fires, and trigger points to execute engagements.	
<b>b. Tasks to maneuver units.</b> Written, for each subordinate unit, on the overlay. Specified tasks for each unit only.	
<b>c. Tasks to other combat and combat support units.</b> Verbal brief, identifies priority of support.	
<b>d. Coordinating instructions.</b> Verbal brief, covers only items not covered in unit SOPs. Focus on control measures and graphics.	
<b>4. SERVICE SUPPORT.</b> Verbal brief, referring to the overlay for locations of support. Any changes to sustainment.	

Figure G-9. Overlay Order Format

**5. COMMAND AND SIGNAL.**

**a. Command.** Verbal brief; refer to the overlay for location of key personnel, and identify the succession of command.

**b. Signal.** Verbal brief, including any code words that key certain events.

**ACKNOWLEDGE:**

[Commander's last name]

[Commander's rank]

**OFFICIAL:**

[Authenticator's Name]

[Authenticator's Position]

[Annexes are not used with overlay orders]

**DISTRIBUTION:**

[Classification]

Figure G-9. Overlay Order Format (continued)

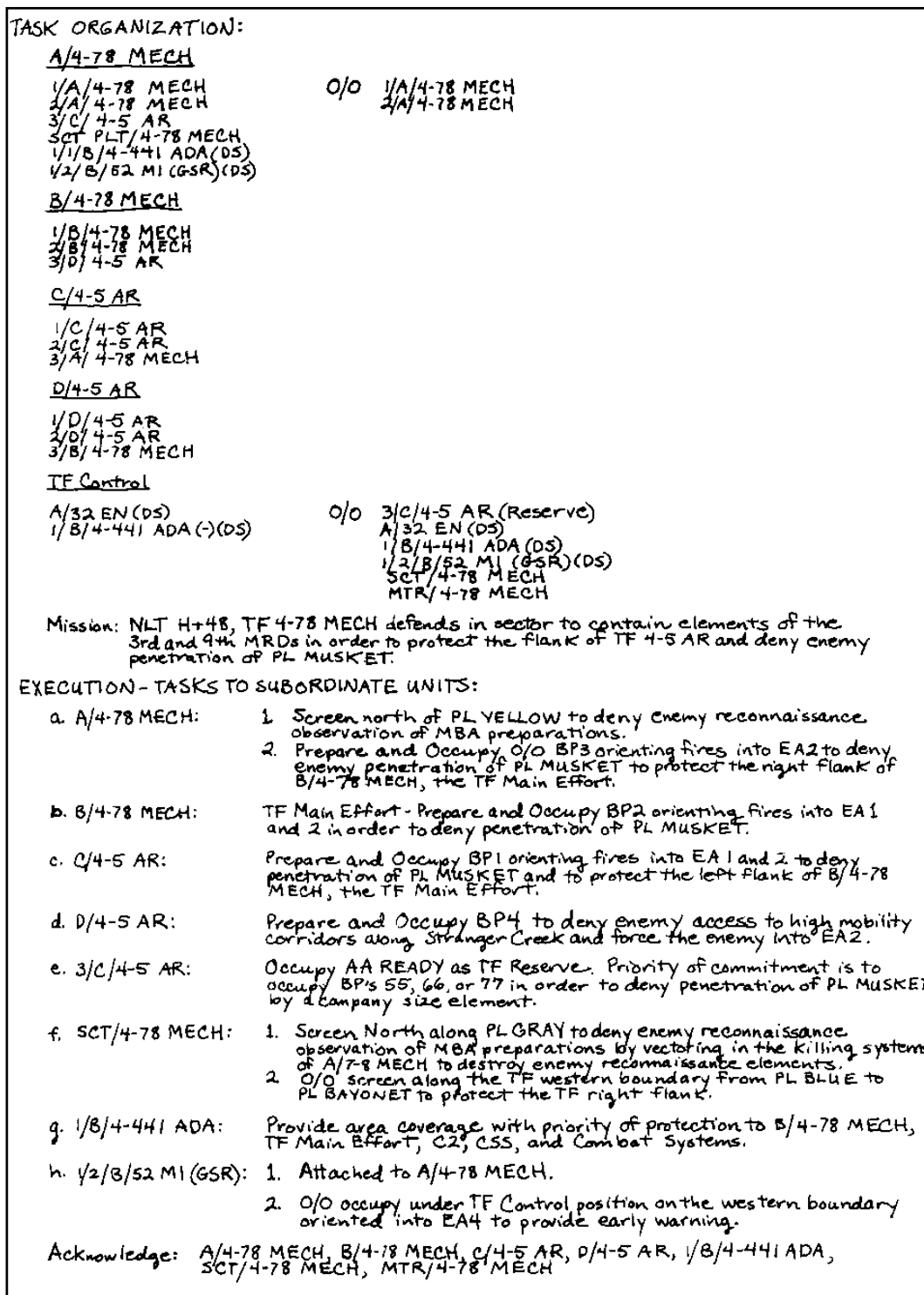

Figure G-10. Overlay Order Example



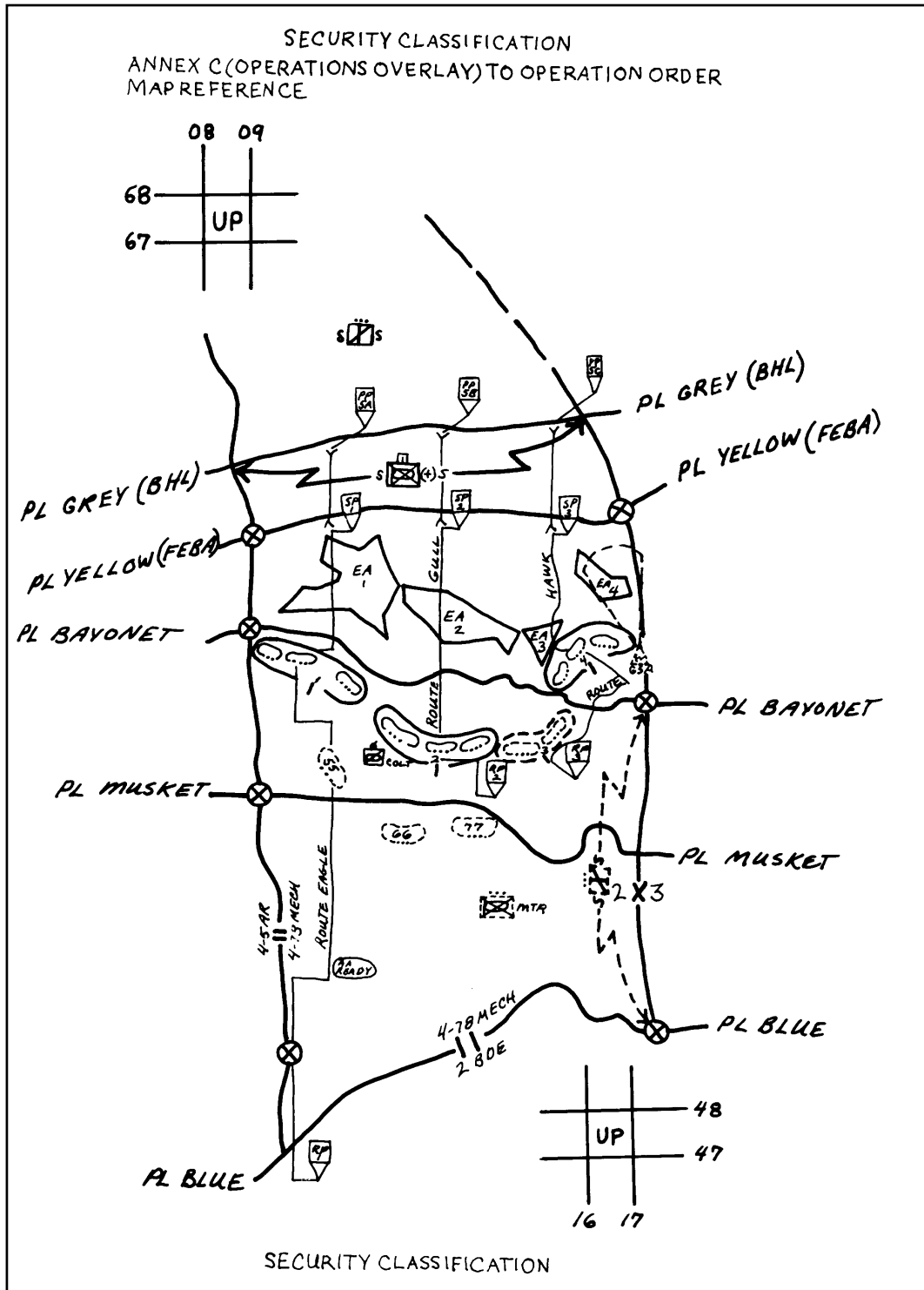

Figure G-10. Overlay Order Example (continued)

<p><b>[Classification]</b></p> <p><b>(Change from verbal orders, if any)</b></p> <p style="text-align: right;"><b>Copy ## of ## copies</b>  <b>Issuing headquarters</b>  <b>Place of issue</b>  <b>Date-time group of signature</b>  <b>Message reference number</b></p> <p>Include heading if attachment is distributed separately from the base order or higher-level attachment.</p> <p><b>[Attachment type and number/letter] ([Attachment Title]) TO [higher-level attachment type and number/letter, if applicable] ([Higher-level attachment title, if applicable]) TO OPERATION PLAN/ORDER [number] [code name]—[issuing headquarters]</b></p> <p>For example, TAB C (Highway Regulation) to appendix 3 (Traffic Circulation and Control) to annex I (Service Support) to OPLAN 02-05 (First Impression)—52d ID</p> <p><b>References:</b></p> <p><b>Time Zone Used Throughout the Order:</b></p> <p><b>1. SITUATION.</b> Include information affecting the functional area that paragraph 1 of the OPLAN/OPORD does not cover or that needs to be expanded.</p> <p style="padding-left: 20px;"><b>a. Enemy forces.</b> See annex B (Intelligence) or intelligence estimate, and analysis of AOs if available. Include the following enemy functional area capabilities and/or activities:</p> <ul style="list-style-type: none"> <li>• List known and templated locations and activities of enemy functional area units. Information is normally gathered one level up and two levels down.</li> <li>• List significant enemy maneuver and functional area capabilities that impact friendly functional area operations.</li> <li>• State the expected employment of enemy functional area assets based on the most probable enemy COA.</li> </ul> <p style="padding-left: 20px;"><b>b. Friendly forces.</b></p> <ul style="list-style-type: none"> <li>• Outline the plan of the higher headquarters as it pertains to the functional area.</li> <li>• List designation, location, and outline of the plan of higher, adjacent, and other functional area assets that support or otherwise impact the issuing headquarters or require coordination, and any other functional area support.</li> <li>• List non-functional area units capable of assisting in functional area operations (such as non-engineer units capable of emplacing scatterable mines).</li> </ul> <p style="padding-left: 20px;"><b>c. Environment.</b></p> <p style="padding-left: 40px;"><b>(1) Terrain.</b> List all critical terrain aspects that impact functional area's operations. Refer to annex E (Engineer) if available.</p> <p style="padding-left: 40px;"><b>(2) Weather.</b> List all critical weather aspects that impact functional area's operations. Refer to annex B (Intelligence) if available.</p> <p style="padding-left: 40px;"><b>(3). Civil consideration.</b> List all critical civil consideration that impact functional area's operations. Refer to annex Q (Civil Military Operations) if available.</p> <p><b>d. Attachments and detachments.</b> List units attached or detached only as necessary to clarify task organization.</p> <p style="text-align: center;"><b>[Classification]</b></p>
--

Figure G-11. Attachment Format (General)

<p><b>[Classification]</b></p> <p><b>[Attachment type and number/letter] ([Attachment Title]) TO [higher-level attachment type and number/letter, if applicable] ([Higher-level attachment title, if applicable]) TO OPERATION PLAN/ORDER [number] [code name]—[issuing headquarters]</b></p> <p>(2) Highlight changes in functional area's task organization that occur during the operation, including effective times or events.</p> <p><b>2. MISSION.</b> State the mission of the functional area in support of the basic OPLAN/OPORD.</p> <p><b>3. EXECUTION.</b></p> <p><b>a. Scheme of support.</b> May be titled "Scheme of (functional area) operations."</p> <ul style="list-style-type: none"> <li>• Describe the concept of functional area operations to support the commander's intent and the maneuver plan. Tie in critical functional area tasks or the functional area's main effort by mission.</li> <li>• Establish the main functional area effort by mission and unit for each phase of the operation.</li> <li>• State functional area priorities.</li> </ul> <p><b>b. Tasks to subordinate units.</b></p> <ul style="list-style-type: none"> <li>• List functional area tasks that specific maneuver elements are to accomplish that the base OPORD does not contain.</li> <li>• List functional area tasks the functional area units supporting maneuver elements are to accomplish only as necessary to ensure unity of effort.</li> </ul> <p><b>c. Coordinating instructions.</b> Include only instructions common to two or more units not already covered in the base OPORD.</p> <ul style="list-style-type: none"> <li>• State specific ROE that apply to the functional area.</li> <li>• Refer to supporting appendixes not referenced elsewhere.</li> <li>• Do not include SOP information.</li> </ul> <p><b>4. SERVICE SUPPORT.</b></p> <p><b>a. Command-regulated classes of supply.</b> Highlight subordinate allocations of command-regulated classes of supply that impact functional area operations (such as the controlled supply rate). Summarize in a matrix or table if necessary.</p> <p><b>b. Supply distribution plan.</b></p> <ul style="list-style-type: none"> <li>• State the method of supply (supply point or unit distribution) to be used for appropriate classes of supply for each subordinate or supporting unit.</li> <li>• Give tentative locations for supply points or locations for linkup of push packages direct to units.</li> <li>• Give allocation of classes of supply by subordinate unit, control measure, or combination. Summarize in a matrix or table, if necessary.</li> </ul> <p><b>c. Transportation.</b> State the allocation and priority of support of haul or airlift assets dedicated for moving classes of supply.</p> <p style="text-align: center;"><b>[Classification]</b></p>
---

Figure G-11. Attachment Format (General) (continued)

**[Classification]**

**[Attachment type and number/letter] ([Attachment Title]) TO [higher-level attachment type and number/letter, if applicable] ([Higher-level attachment title, if applicable]) TO OPERATION PLAN/ORDER [number] [code name]—[issuing headquarters]**

**d. Health service support.** Address arrangements made for health support of functional area units operating in forward maneuver unit areas.

**e. Maintenance.** State priority of support, locations of maintenance facilities, and any relevant policies.

**f. Field services.** State priority of support, locations of facilities, and command policies.

**g. Host nation.**

- List type and location of host nation functional area facilities, assets, or support.
- List procedures for requesting and acquiring host nation functional area support.
- Highlight any limitations or restrictions on host nation support.

**5. COMMAND AND SIGNAL.**

**a. Command.**

- State the location of key functional area leaders.
- Designate a functional area chain of command and succession of command.
- Designate a headquarters to control the effort within functional area work lines on an area basis.
- List command posts and other C2 facilities and their locations.

**b. Signal.**

- State edition number of SOI in effect. Do not write “current SOI in effect.”
- Describe the nets to monitor for reports.
- Designate critical functional area reporting requirements.
- Address any functional-area-specific communications or digitization connectivity requirements or coordination necessary to meet functional responsibilities.

**ACKNOWLEDGE:**

Include only when annex is distributed separately from the base order.

**[Commander’s/coordinating staff officer’s last name]**  
**[Commander’s/coordinating staff officer’s rank]**

Either the commander or the coordinating staff officer responsible for the functional area may sign attachments.

**[TYPE OF ATTACHMENT]:**

List lower level attachments, if any.

**DISTRIBUTION:**

Show only if distributed separately from the base order or higher-level attachment.

**[Classification]**

**Figure G-11. Attachment Format (General) (continued)**

**[Classification]**

Include heading if annex distributed separately from base OPLAN/OPORD.

**ANNEX B (INTELLIGENCE) TO OPERATION ORDER NO ## [code name]—[issuing headquarters]**

**1. SITUATION.**

- a. Enemy Situation.** Refer to appendix 1 (Intelligence Estimate).
- b. Friendly Situation.** Refer to base order and annex C (Operations overlay).
- c. Environment.** Refer to appendix 1 (Intelligence Estimate), appendix 4 (Weather), annex F (engineer), annex Q (Civil Considerations) as required.
- d. Attachments and detachments.**

**2. MISSION.** State the intelligence mission for the operation.

**3. EXECUTION.**

**a. Scheme of intelligence.** Describe the concept of intelligence operations to support the commander's intent and the maneuver plan. Tie in critical intelligence tasks to focus intelligence by phase. Refer to annex L (ISR Plan) for collection requirements.

**b. Tasks to subordinate units.** Refer to annex L (ISR). List intelligence production tasks that MI units supporting maneuver elements are to accomplish only as necessary to ensure unity of effort.

**c. Counterintelligence.** Refer to appendix 3 (Counterintelligence) to annex B.

**d. Coordinating instructions.**

**(1) Requirements.** List each requirement by priority in a separate subparagraph. List the latest time intelligence of value for each requirement and tie each to an operational decision or action.

**(a) Priority intelligence requirements (PIR).**

**(b) Friendly force information requirements (FFIR).**

**(c) Intelligence Requirements.**

**(2) Requests for Information (RFIs).** List RFIs to higher, adjacent, and cooperating units in separate, lettered subparagraphs.

**(3) Measures for handling personnel, documents, and materiel.**

**(a) Prisoners of war, deserters, repatriates, inhabitants, and other persons.** State special handling, segregation instructions, and locations of the command's and next higher headquarters' EPW collection point.

**(b) Captured documents.** List instructions for handling and processing captured documents from time of capture to receipt by specified intelligence personnel.

**(c) Captured materiel.** Designate items or categories of enemy materiel required for examination. Include any specific instructions for their processing and disposition. Note: Medical materiel (supplies and equipment) cannot be intentionally destroyed. Give locations of the command's and next higher headquarters' captured materiel collection point.

**[Classification]**

**Figure G-12. Annex B (Intelligence) Instructions and Format**

[Classification]

**(d) Documents or equipment required.** List in each category the conditions under which units can obtain or request certain documents or equipment. Items may include air photographs and maps, charts, and geodesy (satellite) products.

**(5) Distribution of intelligence products.** State the conditions (for example, dates, number of copies, or issue) regulating the issue of intelligence reports and products to the originating command for the operation's duration. This paragraph may cover any or all of the following:

- Periods that routine reports and distribution address.
- Updates to the threat and environment portions of the COP.
- Formats and methods for push and pull intelligence support.
- Periodic or special intelligence meetings and conferences.
- Distribution of special intelligence studies: such as, defense overprints, photo intelligence reports, and order of battle overlays.
- Special intelligence liaison, when indicated.

List in each category the conditions under which units can obtain or request certain documents or equipment.

**(6) Other instructions.**

**4. SERVICE SUPPORT.** List any unique intelligence service support (for example, contractor support) not addressed in either the base order or annex I (Service Support).

**5. COMMAND AND SIGNAL.**

- a. Identify command intelligence coordination line (ICL).
- b. Identify intelligence liaison requirements.
- c. Identify special security office arrangements and coordination.

**ACKNOWLEDGE:** (if distributed separately from base order).

[Authenticator's last name]

[Authenticator's rank]

**APPENDIXES:**

1. Intelligence Estimate.
2. Intelligence Synchronization Plan.
3. Counterintelligence Plan.
4. Weather.
5. IPB Products.

**DISTRIBUTION:** (if distributed separately from base order).

[Classification]

Figure G-12. Annex B (Intelligence) Instructions and Format (continued)

1. Center the security classification at the top and bottom of the overlay. Use the largest and widest letters possible.
  2. Place the title in the upper left margin (below the security classification). Use the following format: ANNEX C (OPERATION OVERLAY) TO OPERATION ORDER NO ## [code name]—[issuing headquarters].
  3. Place the map reference in the upper left margin immediately below the title.
  4. Place at least two overlay and map reference points (double crosshair reference marks on map grid lines) on opposite corners of the overlay (see figure G-10, page G-40).
- NOTE:** An overlay must always contain the first four items listed here.
5. Prepare the overlay to the scale of the maps subordinate units will use.
  6. Correctly transfer control measures onto the overlay from the higher headquarters' OPLAN/ OPORD.
  7. Provide a list of coordinates for major C2 points, unit locations, coordinating points, as an attachment to the overlay.
  8. Make the overlay consistent with the applicable text from the OPLAN/OPORD.
  9. Place symbols at doctrinally correct locations. (Before placing symbols on an overlay, always consider the effect of terrain and weather.)
  10. Keep the overlay simple, but give enough detail for others to understand the operation and its essential tasks.
  11. Limit control measures to the minimum needed to synchronize the operation and limit possible fratricide.
  12. Make sure control measures give the commander flexibility to react to changing situations or conditions.
  13. When transmitting or storing overlays, roll up or fold the overlay with the classification, title, and map reference visible on the outside.

Figure G-13. Annex C (Operation Overlay) Instructions and Format

**[Classification]**

Include heading if annex distributed separately from base OPLAN/OPORD.

**ANNEX D (FIRE SUPPORT) TO OPERATION ORDER NO## [code name]—[issuing headquarters]**

**1. SITUATION.**

**a. Enemy forces.**

- Include a detailed description of enemy fire support and AD assets.
- List enemy rocket, cannon, and missile artillery units. Include those organic to maneuver units. List all artillery units that can be identified as being committed or reinforcing. Consider all identified artillery units within supporting range as being in support of the committed force. Include the number of possible enemy air sorties by day, if known. Estimate the number, type, yield, and delivery means of enemy NBC weapons available to the committed force.

**b. Friendly forces.**

- (1) State the higher headquarters' concept of fires.
- (2) Provide adjacent units' concept of fires.
- (3) Include supporting air power and naval forces.

**c. Environment.**

- (1). **Terrain.** List all critical terrain aspects that would impact operations. Refer to appendix 3 (Terrain) to annex E (Engineer) as required.
- (2). **Weather.** List all critical weather aspects that would impact operations. Refer to appendix 4 (Weather) to annex B (Intelligence) as required.
- (3). **Civil considerations.** List all critical civil considerations that would impact operations. Refer to annex Q (Civil-Military Operations) as required.

**c. Attachments and detachments.** List fire support resources attached or under the operational control of the unit. List any units detached or under the operational control of other headquarters.

**2. MISSION.** State the fire support mission for the operation.

**3. EXECUTION.**

**a. Concept of fires.** Describe how fires will be used to support the concept of operations. State the priority of fire support. This must be consistent with what is in the concept of fires in the base OPORD/OPLAN. Address essential fire support tasks (EFST) such as counterfire, preparations and counterpreparations, supporting SEAD/J SEAD operations and joint precision strike operations. Address the objectives for using air power, field artillery, and naval gunfire

**b. Air support.**

- (1) **General.** Briefly describe the maneuver commander's concept for the use of air power.
- (2) **Air interdiction (AI).**
- (3) **Close air support (CAS).**
- (4) **Electronic warfare.** Refer to annex P (Information Operations) as required.
- (5) **Reconnaissance and surveillance operations.** Refer to annex L (Intelligence, Surveillance, Reconnaissance) as required.
- (6) **Miscellaneous.** State the following:
  - The air tasking order's effective time period.
  - Deadlines for submission of AI, CAS, search and rescue, and EW requests.
  - The mission request numbering system based on the target numbering system.
  - Joint suppression of enemy air defense taskings from the JFLCC.

**[Classification]**

See Figure G-11 for general instructions on annexes. This figure discusses fire support-specific items.

**Figure G-14. Annex D (Fire Support) Instructions and Format**



## [Classification]

**ANNEX D (FIRE SUPPORT) TO OPERATION ORDER NO ## [code name]—[issuing headquarters]**

- Essential A2C2 measures—such as coordinating altitude, target areas, low-level transit route requirements—identified in the A2C2 annex.

**c. Field artillery support.**

(1) **General.** Include the concept for use of cannon, rocket, and missile artillery in support of decisive and shaping operations.

(2) **Artillery organization for combat.**

(3) **Allocation of ammunition.**

(4) **Miscellaneous.** Include the following:

- Changes to the targeting numbering system.
- The use of pulse repetition frequency codes.
- Positioning restrictions.

**d. Naval gunfire support.**

(1) **General.** Include the concept for use of naval gunfire support.

(2) **Naval gunfire organization.**

(3) **Miscellaneous.**

- Trajectory limitations or minimum safe distances.
- Frequency allocations.
- Reference to a naval gunfire support annex.

**e. Nuclear operations** (corps and EAC only).**f. Smoke operations.**

**g. Target acquisition.** Include information pertaining to the employment and allocation of FA target acquisition systems and EW assets. Refer to the FA support plan for specific target acquisition tasks, if needed.

**h. Coordinating instructions.**

- List the targeting products (target selection standards matrix, high-payoff target list, and attack guidance matrix).
- List fire support coordination measures.
- Refer to time of execution of program of fires relative to H-hour.
- Include rules of engagement.
- List fire support rehearsal times and requirements.
- List target allocations.
- List FASCAM allocations and requirements.

**4. SERVICE SUPPORT.** Identify the location of ammunition transfer points and ammunition supply points, or refer to the logistics annex. List the controlled supply rate.

**5. COMMAND AND SIGNAL.**

[Classification]

Figure G-14. Annex D (Fire Support) Instructions and Format (continued)

<b>[Classification]</b>	
<b>ANNEX D (FIRE SUPPORT) TO OPERATION ORDER NO ## [code name]—[issuing headquarters]</b>	
<b>ACKNOWLEDGE:</b> (if distributed separately from base order).	<b>[Authenticator's last name]</b>
	<b>[Authenticator's rank]</b>
<b>APPENDIXES:</b>	
1. Air Support.	
2. Field Artillery Support.	
3. Naval Gunfire Support.	
<b>DISTRIBUTION:</b> (If distributed separately from base order).	
<b>[Classification]</b>	

Figure G-14. Annex D (Fire Support) Instructions and Format (continued)

<p><b>ANNEX E (RULES OF ENGAGEMENT) TO OPERATION ORDER NO## [code name]—[issuing headquarters]</b></p>	
<p><b>1. SITUATION.</b></p>	
<p><b>a. General.</b> Describe the general situation anticipated when the operation is executed. Provide all information needed for insight concerning the ROE.</p>	<p>See Figure G-11 for general instructions on completing annexes. This figure discusses ROE-specific items.</p>
<p><b>b. Enemy forces.</b> Refer to annex B (Intelligence). Describe enemy capabilities, tactics, techniques, and probable COAs that may affect existing or proposed ROE.</p>	
<p><b>c. Friendly forces.</b> State in separate subparagraphs the friendly forces that require individual ROE; for example, army aviation. Also state the ROE each.</p>	
<p><b>d. Environment.</b> State any ROE that has applicability to the civilian population in the area of operations.</p>	
<p><b>d. Assumptions.</b> List all assumptions on which ROE are based.</p>	
<p><b>2. MISSION.</b></p>	
<p><b>3. EXECUTION.</b></p>	
<p><b>a. Concept of operations.</b> Summarize the concept of operations and state the general application of ROE in support of it. Indicate the times (hours, days, or events) ROE are in effect.</p>	
<p><b>b. Tasks.</b> Provide guidance for ROE development and approval by subordinate units.</p>	
<p><b>c. Coordinating Instructions.</b> Include the following, as a minimum:</p>	
<ul style="list-style-type: none"> <li>• Coordination of ROE. Include requirements for ROE coordination with adjacent commands, friendly forces, appropriate foreign forces, third countries, appropriate civilian agencies, and Department of State elements.</li> <li>• Dissemination of ROE.</li> <li>• Provision of ROE to augmentation forces of other commanders.</li> <li>• Procedures for requesting and processing changes to ROE.</li> <li>• Special reports requirements.</li> </ul>	
<p><b>4. SERVICE SUPPORT.</b></p>	
<p><b>5. COMMAND AND SIGNAL.</b> Refer to the appropriate section of annex H (C4). Provide pertinent extracts of information required to support the basic plan, including—</p>	
<ul style="list-style-type: none"> <li>• Identification, friend or foe, or neutral ROE policy.</li> <li>• Relation of ROE to use of code words.</li> <li>• Geographic boundaries or control measures within which ROE apply.</li> <li>• Special systems and procedures applicable to ROE.</li> </ul>	
<p><b>ACKNOWLEDGE:</b> (if distributed separately from base order)</p>	
<p><b>[Authenticator's last name and rank]</b></p>	
<p><b>APPENDIXES:</b></p>	
<p>1. ROE Card.</p>	
<p><b>DISTRIBUTION:</b> (if distributed separately from base order).</p>	

Figure G-15. Annex E (Rules of Engagement) Instructions and Format

**[Classification]**

**ANNEX F (ENGINEER) TO OPERATION ORDER NO## [code name]—[issuing headquarters]**

Include heading if annex distributed separately from base OPLAN/OPORD.

**1. SITUATION.**

**a. Enemy forces.** Include a detailed description of enemy engineer units and assets and know obstacles. Refer to annex B (Intelligence) as required.

**b. Friendly forces.** State the higher headquarters concept of engineer support and provide adjacent units' concept of engineer support.

**c. Environment.** In separate subparagraphs list all critical terrain, weather, and civil considerations that would impact engineer operations. Refer to appropriate annexes as required.

**d. Attachments and detachments.** List all mobility/countermobility/survivability assets with a command support relationship with higher headquarters. List any units detached or under the operational control of other headquarters.

See Figure G-11 for general instructions on completing annexes. This figure discusses engineer-specific items.

**2. MISSION.** State the engineering mission in support of the operation.

**3. EXECUTION.**

**a. Scheme of Engineering Operations.**

Same scheme as in basic OPLAN/OPORD.

- Provide narrative of mobility/countermobility/survivability, general engineering and geospatial engineering tasks required to enable success of the supported scheme of maneuver.
- List essential mobility/countermobility/survivability tasks: include task, purpose, method, and effect. Explain how they support the scheme of maneuver.
- Ensure the scheme of mobility/countermobility/survivability operations corresponds to the maneuver unit concept of operations, which provides the foundation and structure for mobility/countermobility/survivability operations. If the operation is phased, the scheme of mobility/countermobility/survivability operations is also phased, using the same phases. If not, the scheme of mobility/countermobility/survivability operations uses the same format as supported unit's concept of operations.
- Address required areas under each phase: general comments, mobility, counter-mobility, survivability, general engineering, smoke, and EOD and force protection. Address each in order of priority by phase. If there is no support provided in an area during a phase, do not mention that area. The support addressed under each phase applies to the mobility and survivability effort that supports a maneuver unit during that phase, no matter when the effort was completed. Address each area as follows:
  - **General comments:** a brief, one-sentence comment about mobility/countermobility/survivability operations for the phase.
  - **Counter-mobility:** each directed obstacle belt, group or individual obstacle, in order of its priority, its intent (target, location, effect), and which maneuver unit is responsible for it. Provide execution criteria for reserve targets and situational obstacles.
  - **Survivability:** each survivability task and relative location; for example, battle position, and maneuver unit responsible. (This includes smoke operations used for survivability purposes; for example, obscuration during breaches).

**[Classification]**

**Figure G-16. Annex F (Engineer) Instructions and Format**

## [Classification]

**ANNEX F (ENGINEER) TO OPERATION ORDER NO## [code name]—[issuing headquarters]**

- **Mobility:** each mobility task (breaching, proofing, marking lanes, providing guides, and maintaining a route), relative location (route or objective), priority of reduction asset used (use plows first, then mine-clearing line charge), and unit responsible.

- **General Engineering:** each general engineering task, location, priority, the executing unit and the ground commander responsible.

**b. Tasks to subordinate units.** List mobility/countermobility/survivability tasks that specific maneuver units are to accomplish that are not assigned in the base OPORD. List tasks to specific mobility/countermobility/survivability assets supporting maneuver units only as necessary to ensure unity of effort. (Tasks listed in the annex should be sub-tasks or supporting tasks to those assigned in the base order and listed only as necessary to clarify or ensure unity of effort. All essential mobility/countermobility/survivability tasks must be captured in the base order.) This paragraph is used to inform subordinate unit commanders of tasks under unit control being done by unit-level forces.

**c. Coordinating instructions.**

- Include times or events in which obstacle control measures become effective if they differ from the effective time of the order.
- List supported unit mobility/countermobility/survivability focused PIR that must be considered by subordinate engineer staff officers or that the supported unit requires.
- List mission reports that the supported unit requires if not covered in the signal paragraph or unit SOP.
- Include explanation of countermobility and survivability time lines, if used. Refer to appendix 4 (mobility/countermobility/survivability execution matrix/timeline) as required.

**4. SERVICE SUPPORT.**

**a. Command-regulated classes of supply.** Identify command-regulated classes of supply. Highlight supported unit allocations that affect engineer CSR.

**b. Supply distribution plan.** Establish a Class IV and V (obstacle) supply distribution plan. State method of supply for each class, for each supported unit subordinate element.

- List supply points of linkup points.
- List allocations of Class IV and V (obstacle) by support unit element by obstacle control measure or combination. May summarize in a matrix or table.

**c. Transportation.**

[Classification]

Figure G-16. Annex F (Engineer) Instructions and Format (continued)

**d. Health service support.**

**e. Host nation.**

- Include host nation coordination.
- List type and location of host nation engineer facilities, assets, or support.
- List procedures for requesting and acquiring host nation engineer support.
- Identify any limitations or restrictions on host nation support.

**5. COMMAND AND SIGNAL.**

**a. Command.** Designate the headquarters that controls the mobility/countermobility/survivability effort within work lines on an area basis. Clearly identify the release authority for special munitions and mines.

**b. Signal.**

- Identify communication networks monitored by the unit engineer, if different than SOP.
- Identify critical mobility/countermobility/survivability reporting requirements of subordinates if not covered in SOP.

**ACKNOWLEDGE:** (if distributed separately from base order).

**[Authenticator's last name]**  
**[Authenticator's rank]**

**APPENDIXES:**

1. Obstacle Overlay.
2. Environmental Considerations.
3. Terrain.
4. Mobility/countermobility/survivability execution matrix/timeline.
5. EOD.

**DISTRIBUTION:** (if distributed separately from base order).

**[Classification]**

**Figure G-16. Annex F (Engineer) Instructions and Format (continued)**

**[Classification]**

**ANNEX G (AIR AND MISSILE DEFENSE) TO OPERATION ORDER ## [code name] — [issuing headquarters]**

Include heading if annex distributed separately from base OPLAN/OPORD.

**1. SITUATION.**

**a. Enemy forces.** See annex B (Intelligence). Identify most likely enemy ingress and egress routes. Identify enemy aircraft all-weather capabilities and limitations, to include enemy air capability and/or activity.

**(1) Air threat data.** Air-capable organization, including air platforms, by number and type.

**(2) Additional air threat information.** Include air threat information pertinent to the operation but not covered in annex B (Intelligence). Highlight specific air threat considerations: such as sortie rates, subordination of air elements to ground units, ordnance peculiarities, target preferences, tactics, recent significant activities, and tactical ballistic missile threats.

**(3) Air avenues of approach.** List all expected air avenues of approach. Identify their potential users by air platform. List all known beginning points and describe avenue of approach as it goes through the area of interest.

**b. Friendly forces.** List ADA missions at all applicable levels. Describe how the air defense plan integrates with higher-echelon plans.

**(1) Higher units.** Outline higher air defense unit concept and plans.

**(2) Adjacent units.** Outline adjacent air defense unit concept and plans.

**(3) Supporting elements.** Note supporting units and support relationship.

**c. Environment.** In separate subparagraphs list all critical terrain, weather, and civil considerations that would impact air and missile defense operations. Refer to appropriate annexes as required.

**d. Attachments and detachments.** Identify air defense resources attached from other commands. Identify air defense resources detached.

**2. MISSION.** State the mission of air and missile defense in support of the operations.

**3. EXECUTION.**

**a. Scheme of air and missile defense support.** Commander's overall air and missile defense plan, including the concept, objectives, and priorities.

**b. Tasks to subordinate ADA units.** Briefly discuss the ADA plan, command and support relationships, and priority of protection.

**c. Coordinating instructions.** Include references to other applicable attachments.

- Weapons control status and weapons control status authority. Include any plans to change weapons control status.
- Hostile criteria. Basic rules the commander has established to assist in the identification of friendly or hostile air vehicles. Include preplanned changes.
- ROE. Address ROE unique to the operation or points in the operation where changes are intended. Include use of supplemental fire control measures.

**[Classification]**

Figure G-17. Annex G (Air and Missile Defense) Instructions and Format

<p><b>[Classification]</b></p> <p><b>ANNEX G (AIR AND MISSILE DEFENSE) TO OPERATION ORDER NO ## [code name]—[issuing headquarters]</b></p> <ul style="list-style-type: none"><li>• Passive air defense. Specific passive air defense measures that all units should take to protect themselves from air and missile attack or surveillance during this operation.</li><li>• Combined arms for air defense. Specific techniques units should use to defend themselves against a missile attack and/or surveillance.</li><li>• Early warning. Method and format for passing early warning to the force.</li></ul> <p><b>4. SERVICE SUPPORT.</b></p> <p><b>5. COMMAND AND SIGNAL.</b></p> <ul style="list-style-type: none"><li><b>a. Command.</b></li><li><b>b. Signal.</b><ul style="list-style-type: none"><li>• Identification, friend or foe code edition and book number.</li><li>• Communications links for early warning equipment.</li></ul></li></ul> <p><b>ACKNOWLEDGE:</b> (if distributed separately from base order).</p> <p style="text-align: right;"><b>[Authenticator's last name]</b> <b>[Authenticator's rank]</b></p> <p><b>APPENDIXES:</b></p> <p><b>DISTRIBUTION:</b> (if distributed separately from base order).</p> <p style="text-align: center;"><b>[Classification]</b></p>
---

Figure G-17. Annex G (Air and Missile Defense) Instructions and Format (continued)



<p><b>[Classification]</b></p> <p>Include heading if annex distributed separately from base OPLAN/OPORD.</p> <p><b>ANNEX H (COMMAND, CONTROL, COMMUNICATION, and COMPUTER OPERATIONS) TO OPERATION ORDER NO ## [code name]—[issuing headquarters]</b></p> <p><b>1. SITUATION.</b></p> <p><b>a. Enemy forces.</b> Refer to annex B, appendix 1-Intelligence estimate. Also provide enemy capability and activity by describing enemy capabilities that may affect communications systems.</p> <p><b>b. Friendly forces.</b></p> <ul style="list-style-type: none"> <li>• Primary communications gateways providing connectivity to higher, lower, and adjacent units.</li> <li>• Critical communications security measures required to counter expected enemy EW capabilities and protect C2 systems.</li> <li>• External communications assets that augment signal support unit capabilities.</li> </ul> <p><b>c. Environment.</b> In separate subparagraphs list all critical terrain, weather, and civil considerations that would impact C4 operations. Refer to appropriate annexes as required.</p> <p><b>d. Attachments and detachments.</b></p> <p><b>2. MISSION.</b> State the C4 operations mission in support of this operation.</p> <p><b>3. EXECUTION.</b></p> <p><b>a. Scheme of signal support operations.</b></p> <ol style="list-style-type: none"> <li>(1) Describe the concept of signal operations, including primary and back-up systems supporting critical C2 networks.</li> <li>(2) Outline the plan for extending C2 systems by each phase of the operation.</li> <li>(3) List critical links between tactical and strategic communications systems.</li> <li>(4) Identify critical limitations of organic signal support assets. Define limitations of assets from higher headquarters.</li> <li>(5) State signal support tasks that all non-signal units must perform to accomplish missions and tasks beyond normal requirements.</li> <li>(6) State signal support priorities.</li> </ol> <p><b>b. Tasks to subordinate units.</b></p> <ul style="list-style-type: none"> <li>• Signal support tasks that maneuver elements must accomplish that the base OPLAN/OPORD does not contain.</li> <li>• Signal support tasks that signal units supporting maneuver elements are to accomplish only as necessary to ensure unity of effort.</li> </ul> <p><b>c. Coordinating instructions.</b></p> <ul style="list-style-type: none"> <li>• Critical signal support instructions not already covered in the base OPLAN/OPORD.</li> </ul> <p style="text-align: center;"><b>[Classification]</b></p>	<p>See Figure G-11 for general instructions on completing annexes. This figure discusses C4-specific items.</p>
---	---

**Figure G-18. Annex H (Command, Control, Communication, and Computer Operations) Instructions and Format**

**[Classification]**

**ANNEX H (COMMAND, CONTROL, COMMUNICATION, and COMPUTER OPERATIONS) TO OPERATION ORDER NO ## [code name]—[issuing headquarters]**

- Key times or events critical to INFOSYS and network control procedures.
- Army Battle Command System control procedures.

**4. SERVICE SUPPORT.**

**5. COMMAND AND SIGNAL.**

- a. Identify C2 systems control hierarchy for the common user network.
- b. Identify local area network control procedures for network administration and management.
- c. Use appendixes to diagram any changes to standard communications networks.

**ACKNOWLEDGE:** (if distributed separately from base order).

**[Authenticator's last name]**  
**[Authenticator's rank]**

**APPENDIXES:**

**DISTRIBUTION:** (if distributed separately from base order).

**[Classification]**

**Figure G-18. Annex H (Command, Control, Communication, and Computer Operations) Instructions and Format (continued)**

<p><b>[Classification]</b></p> <p>Include heading if annex distributed separately from base OPLAN/OPORD.</p> <p><b>ANNEX I (SERVICE SUPPORT) TO OPERATION ORDER NO ## [code name]— [issuing headquarters]</b></p> <p><b>1. SITUATION.</b></p> <p><b>2. MISSION.</b></p> <p><b>3. EXECUTION.</b></p> <p><b>4. SERVICE SUPPORT.</b></p> <p><b>a. Materiel and services.</b></p> <p><b>(1) Supply.</b> For each class of supply, list supply point locations and state supply plan and procedures. Post supply point locations to service support matrix and overlay.</p> <p><b>(a) Class I (Rations).</b> List ration cycle.</p> <p><b>(b) Class II (Organizational clothing and individual equipment and maps).</b> Classified map requests are submitted through S-2/G-2 channels.</p> <p><b>(c) Class III (Bulk fuel; package petroleum, oils, and lubricants).</b></p> <p><b>(d) Class IV (Construction and fortification material).</b> List command-controlled items.</p> <p><b>(e) Class V (Munitions).</b> List CSRs and procedures to request EOD support.</p> <p><b>(f) Class VI (Personal demand items).</b> Health and comfort packs and items normally sold through the exchange service.</p> <p><b>(g) Class VII (Major end items).</b> List command-controlled items.</p> <p><b>(h) Class VIII (Medical material).</b></p> <p><b>(i)</b> List medical chemical defense material and blood supply requirements.</p> <p><b>(j) Class IX (Repair parts).</b> State the approving authority for controlled exchange of parts. List critical shortages and command-controlled items.</p> <p><b>(k) Class X (Material for nonmilitary or civil-military operations).</b></p> <p><b>(l) Miscellaneous.</b> Items that are not one of the 10 supply classes. List maps, water, special supplies, and excess and salvage materiel, as applicable.</p> <p><b>(2) Transportation.</b> For each subparagraph, identify facility locations, traffic control, regulation measures, MSRs, ASRs, transportation critical shortages, and essential data not provided elsewhere. Post MSRs, ASRs, and transportation nodes to service support overlay. List transportation request procedures.</p> <p><b>(a) Land.</b></p> <p><b>(b) Sea.</b></p> <p style="text-align: center;"><b>[Classification]</b></p>	<p>See Figure G-11 for general instructions on completing annexes. This figure discusses service support-specific items.</p>
---	--

Figure G-19. Annex I (Service Support) Instructions and Format

**[Classification]**

**ANNEX I (SERVICE SUPPORT) TO OPERATION ORDER NO ## [code name]—  
[issuing headquarters]**

**(c) Air.**

**(3) Services.** Identify services available, the designation and location of units providing them, and the time they are available. List procedures for requesting services by type. Post services information to service support matrix and overlay.

**(a) Construction.**

**(b) Showers, laundry, and clothing repair and light textile repair.**

**(c) Mortuary affairs.**

**(d) Food preparation.**

**(e) Water purification.**

**(f) Aerial delivery.**

**(g) Installation service.**

**(4) Labor.**

**(5) Maintenance.** For each subparagraph, include maintenance priority, location of facilities and collection points, repair time limits at each maintenance level, and evacuation procedures. Post maintenance points to service support matrix and overlay.

**(a) Air.**

**(b) Ground.**

**(c) Watercraft.**

**b. Health service support.** State plan for collection and medical treatment of sick, injured, or wounded US and multinational soldiers, EPW, detained and retained personnel, and when authorized civilians. Discuss support requirements for health service logistics (including blood management), combat operational stress control, preventive medicine, dental services, medical laboratory support, and veterinary services. Post hospital locations and information to service support matrix and overlay.

**(1) Evacuation.** Medical evacuation. Address the theater evacuation policy, en route care, medical regulating (if appropriate), casualty evacuation, and the medical evacuation of NBC contaminated casualties.

**(2) Hospitalization.** Medical treatment and area support. Location of medical treatment facilities, units without organic medical resources requiring support on area basis, procedures for mass casualty operations, and patient decontamination operations. List levels of medical care (I, II, III, IV) by treatment facility.

**c. Personnel.** Outline plans for unit strength maintenance; personnel management; morale development and maintenance; discipline, law and order; headquarters management; force provider; religious support, legal, and finance support. Post locations and information to service support matrix and overlay.

**(1) Unit strength maintenance.**

**[Classification]**

**Figure G-19. Annex I (Service Support) Instructions and Format (continued)**

**[Classification]**

**ANNEX I (SERVICE SUPPORT) TO OPERATION ORDER NO ## [code name]—  
[issuing headquarters]**

**(2) Morale.**

**d. Foreign nation and host nation support.**

**e. Miscellaneous.** Logistic and personnel reports format usually as per SOP or included in an appendix. List any allocation rules in effect.

**5. COMMAND AND SIGNAL.**

**ACKNOWLEDGE:** (if distributed separately from base order).

**[Authenticator's last name]  
[Authenticator's rank]**

**APPENDIXES:**

1. Service Support Matrix.
2. Service Support Overlay.
3. Traffic Circulation and Control.
  - Tab A. Traffic Circulation (Overlay).
  - Tab B. Road Movement Table.
  - Tab C. Highway Regulations.
4. Personnel.
5. Legal.
6. Religious Support.
7. Foreign and Host-Nation Support.
8. Contracting Support.
9. Reports.

**DISTRIBUTION:** (if distributed separately from base order).

**[Classification]**

Figure G-19. Annex I (Service Support) Instructions and Format (continued)

**[Classification]**

Include heading if annex distributed separately from base OPLAN/OPORD.

**ANNEX J (Nuclear, Biological, and Chemical Operations) TO OPERATION ORDER NO ## [code name]—[issuing headquarters]**

**1. SITUATION.**

**a. Enemy situation.**  
Address NBC threat, including smoke, flame, and riot-control agents.

**b. Friendly situation.**

**c. Environment.** In separate subparagraphs list all critical terrain, weather, and civil considerations that would impact NBC operations. Refer to appropriate annexes as required.

**d. Attachments and detachments.**

**2. MISSION.** State the NBC mission in support of this operation.

**3. EXECUTION.**

**a. Scheme of NBC operations.** Briefly state the NBC defense operation to be carried out. State smoke synchronization plan.

**b. Tasks to subordinate units.** Include subordinate and supporting chemical unit tasks, missions, and priorities for NBC reconnaissance, surveillance, & decontamination operations.

**c. Coordinating instructions.** Address—

- MOPP-level guidance.
- Automatic masking criteria.
- Troop safety criteria.
- Linkup points for decontamination sites.
- Locations of medical facilities conducting patient decontamination and treatment of NBC contaminated casualties.
- Nonmedical soldier support requirements for conducting patient decontamination under medical supervision.
- Turn-in points and procedures for handling chemical and biological samples.
- Civilian and military facilities whose destruction could create militarily significant NBC hazards.
- Operational exposure guidance (if applicable).
- Procedures for limiting electromagnetic pulse effects.
- Identification of designated observer units.
- Identification of procedures for providing support to local populations.

**4. SERVICE SUPPORT.** Address—

- Procedures for handling contaminated casualties and processing remains, if not in SOP. State the battlefield interment authority.
- Information on the availability and location of field expedient decontamination supplies, materials, and decontaminants.

See Figure G-11 for general instructions on completing annexes. This figure discusses NBC-specific items.

**[Classification]**

Figure G-20. Annex J (Nuclear, Biological, and Chemical Operations) Instructions and Format

**[Classification]**

**ANNEX J (Nuclear, Biological, and Chemical Operations) TO OPERATION ORDER NO ## [code name]—[issuing headquarters]**

- Information about the availability, procedures for distributing, prestock points, and transportation of NBC equipment and chemical defense equipment.
- Procedures for chemical defense equipment push-package concept.

**5. COMMAND AND SIGNAL.**

**a. Command.** Locations of chemical staffs and subordinate and supporting chemical unit headquarters.

**b. Signal.**

- Special signal instructions to subordinate and supporting chemical units.
- Information concerning the NBC warning and reporting system.
- Information concerning dissemination of strike warning messages.

**ACKNOWLEDGE:** (if distributed separately from base order).

**[Authenticator's last name]**  
**[Authenticator's rank]**

**APPENDIXES:**

**DISTRIBUTION:** (if distributed separately from base order).

**[Classification]**

Figure G-20. Annex J (Nuclear, Biological, and Chemical Operations) Instructions and Format (continued)

**[Classification]**

**ANNEX K (PROVOST MARSHAL) TO OPERATION ORDER NO ## [code name]—  
[issuing headquarters]**

Include heading if annex distributed separately from base OPLAN/OPORD.

**1. SITUATION.**

**2. MISSION.**

**3. EXECUTION.**

**a. Scheme of provost marshal operations.**

State the provost marshal concept to employ military police assets. Focus on the mission, commander’s intent, and guidance; how provost marshal operations support to the fight; and how they are nested.

See Figure G-11 for general instructions on completing annexes. This figure discusses provost marshal-specific items.

**(1) Maneuver and mobility support.**

Outline the circulation control plan. Focus on maneuver unit mobility to minimize interference with movement within and through the rear area. Include the following:

- Route reconnaissance and surveillance (refer to annex L as required).
- MSR regulation enforcement.
- Contamination avoidance.
- Straggler control.
- Dislocated civilian control.
- Tactical and criminal intelligence collecting and reporting (refer to annexes B and L as required).

**(2) Area Security.** Develop rear area protection plan, including levels II and III response actions (base and base cluster defense); synchronize with the ISR plan. Include the following:

- Security of critical assets.
- Base response force (levels I, II, III).
- Counter-reconnaissance and response force activities.
- Air base defense.
- Counterterrorism and antiterrorism activities.
- Area damage control.
- NBC detection and reporting.
- Force protection/physical security.

**(3) Internment and resettlement operations.** List locations of EPW, detainee, or internee holding areas. Coordinate with appropriate rear command post or staff element on population data (such as number and location). Plan and direct operations (collection, detention, internment, protection measures, sustainment, and evacuation). Coordination required with the medical command for EPW evacuated through medical channels. Coordinate with G-4/S-4 and host nation as necessary.

**[Classification]**

**Figure G-21. Annex K (Provost Marshal) Instructions and Format**



[Classification]

**ANNEX K (PROVOST MARSHAL) TO OPERATION ORDER NO ## [code name]—  
[issuing headquarters]**

**(4) Law and order operations.** Outline plan to maintain law and order from the rear area forward to maneuver units. Determine investigative assets, develop MP patrol routes. Establish criteria for apprehension and detention of US military prisoners.

**(5) Police intelligence operations.** Outline coordination with criminal investigation division, MP, and MI relative to the collection, integration, and dissemination of police intelligence and information.

**b. Tasks to subordinate units.** List tasks to be accomplished by general support and direct support units.

**c. Coordinating instructions.** Include instructions on MP general support missions that apply to two or more subordinate units. Refer to other appendixes or annexes as necessary.

- State required coordination and cooperation among adjacent and other units, and civilian HN agencies, for example, with engineers concerning building and hardening EPW holding area.

- State actions pertaining to rear area force protection that may expand or differ from the SOP.

**4. SERVICE SUPPORT.**

**5. COMMAND AND SIGNAL.**

**ACKNOWLEDGE:** (if distributed separately from base order).

[Authenticator's last name]  
[Authenticator's rank]

**APPENDIXES:**

**DISTRIBUTION:** (if distributed separately from base order).

[Classification]

Figure G-21. Annex K (Provost Marshal) Instructions and Format (continued)

**[Classification]**

Include heading if annex distributed separately from base OPLAN/OPORD.

**ANNEX L (INTELLIGENCE, SURVEILLANCE, AND RECONNAISSANCE) TO OPERATION ORDER NO## [code name]—[issuing headquarters]**

**1. SITUATION.**

**a. Enemy Situation.** Refer to annex B (Intelligence).

**b. Friendly Situation.** Refer to base order, annex A (Task Organization), and annex C (Operations).

**c. Environment.** In separate subparagraphs list all critical terrain, weather, and civil considerations that would impact ISR operations. Refer to appropriate annexes as required.

**2. MISSION.** State the ISR mission in support of the operation.

**3. EXECUTION.**

**a. Concept of ISR Operations.** State the overall reconnaissance objective. Describe the concept of ISR operations to support the commander's intent and the maneuver plan. The concept of ISR operations expresses how each element of the force will cooperate to accomplish the ISR mission and how it is tied to supporting the unit's overall operation. Describe how actions of subordinate units and assets fit together by task and purpose. As a minimum, the concept of ISR operations addresses the ISR scheme of maneuver and concept of fires. Refer to appendix 2 (ISR Overlay) to annex L (ISR). Discuss details of the concept of ISR operations in subparagraphs as necessary, based on what the commander considers appropriate, the level of command, and the complexity of ISR operations. Omit unnecessary subparagraphs. The following subparagraphs are examples of what may be required within the concept of ISR operations.

**(1) Maneuver.** State the scheme of maneuver for ISR units. This paragraph must be consistent with force concept of operations (base order, paragraph 3a) and annex C (Operations). Detail how reconnaissance and surveillance units and assets operate in relation to the rest of the force. State the method reconnaissance forces will use to get to the AO (infiltration, penetration of enemy security zone, passage of lines, and so on). Refer to appendix 1 (ISR Overlay) to annex L; annex C, (Operations), or the base OPLAN/OPORD if required.

**(2) Fires.** State the concept of fires in support of ISR operations. This subparagraph states which ISR elements have priority of fires. It states the purpose of, priorities for, allocation of, and restrictions for fire support and fire support coordinating measures. Refer to annex D (Fire Support) if required.

**(3) Intelligence.** State the intelligence system concept for supporting ISR operations. Refer to annex B (Intelligence) if required.

**(4) Engineer.** Clarify the scheme of engineer support for ISR operations. Indicate priority of effort. Provide priority of mobility and survivability assets as appropriate. Delegate or withhold authority to emplace obstacles. Refer to annex F (Engineer) and other annexes as required.

**[Classification]**

See Figure G-11 for general instructions on completing annexes. This figure discusses ISR-specific items.

**Figure G-22. Annex L (Intelligence, Surveillance, and Reconnaissance) Instructions and Format**

## [Classification]

**ANNEX L (INTELLIGENCE, SURVEILLANCE, AND RECONNAISSANCE) TO OPERATION ORDER NO## [code name]—[issuing headquarters]**

**(5) Air and Missile Defense.** State the overall concept of air and missile defense in support of ISR operations. Establish priority of air defense support and provide air defense weapons status and warning status. Ensure airspace coordination measures are published. Include UAV considerations. Refer to annex G (Air and Missile Defense) as required.

**(6) Force protection.**

**(7) Information Operations.** State overall concept of synchronizing ISR operations with information operations. Establish priority of support. Refer to annex P (Information Operations) and other annexes as required.

**b. Tasks to maneuver units.** List by unit ISR tasks not contained in the base order. Refer to appendix 1 (ISR Tasking Plan/Matrix). Tasks may contain collection tasks.

**(1) Collection Tasks to Maneuver Units.** Clearly state the tasks and purposes for each maneuver unit supporting ISR execution that reports directly to the headquarters issuing the order. State the reconnaissance objective for the unit. Describe how the unit will get to its assigned area (routes, passage points, infiltration lanes, and so on). Use a separate subparagraph for each maneuver unit. Specific reconnaissance and surveillance tasks locations (NAIs), time, and reporting requirements as identified in appendix 1 (ISR Tasking Plan/Matrix).

**(2) ISR Support Tasks to Maneuver Units.**

**c. Tasks to other combat and combat support units.** List by unit ISR tasks not contained in the base order. Refer to appendix 1 (ISR Tasking Plan/Matrix). Tasks may contain collection tasks.

**(1) Collection Tasks to CS Units.** Use these subparagraphs only as necessary. Clearly state the tasks and purposes each CS unit that supports ISR execution. Specific reconnaissance and surveillance tasks locations (NAIs), time, and reporting requirements as identified in the reconnaissance and surveillance plan or matrix.

**(2) ISR Support Tasks to CS Units.**

**(a) Military Intelligence.** Address the function or support roles of MI units, if not clear in the task organization.

**(b) Engineer.** Annex F (Engineer). List organization for ISR operations, if not in the task organization. Assign priorities of effort and support. Address functions or support roles of organic or attached engineer units if it is not clear in task organization. Clearly state any reconnaissance or surveillance task needed to support ISR operations. Establish priorities of work if not addressed in unit SOPs.

**(1) Engineer units, priorities of work.****(2) Environmental considerations.**

[Classification]

**Figure G-22. Annex L (Intelligence, Surveillance, and Reconnaissance) Instructions and Format (continued)**

**[Classification]**

**ANNEX L (INTELLIGENCE, SURVEILLANCE, AND RECONNAISSANCE) TO OPERATION ORDER NO## [code name]—[issuing headquarters]**

**(c) Fire Support.** Refer to annex D (Fire Support). Clearly state any reconnaissance or surveillance task needed to support ISR operations (target acquisition radar, COLTs).

**(1) Air support.** State allocation of close air support (CAS) sorties, AI sorties and nominations (division). Show tactical air reconnaissance sorties to include UAV missions.

**(2) Field artillery support.** Cover priorities such as counter-fires or interdiction. State organization for combat, to include command and support relationships only if they are not clear in task organization. Ensure that allocation of fires supports the commander's concept.

**(3) Naval gunfire support.**

**(4) Fire support coordinating measures.**

**(d) Air and Missile Defense.** Annex G (Air and Missile Defense). Clearly state any reconnaissance or surveillance task needed to support ISR operations (sentinel radar, etc.) Ensure that airspace coordination measures for UAV restricted operating zones is published. Address the following for organic and attached AD units if not addressed in unit SOPs:

**(1) Organization for combat.**

**(2) Missions.**

**(3) Priorities for protection.**

**(e) Signal.** Address functions or support roles of signal units if it is not clear in task organization. Clearly demonstrate how C4 supports ISR operations (necessary retransmitters). Establish priorities of work if not addressed in unit SOPs. Refer to annex H (C4 Operations).

**(f) NBC.** Annex J (NBC). Clearly state any reconnaissance or surveillance task needed to support ISR operations (NBC Recon PLT). Assign priorities of effort and support. Address functions or support roles of organic or attached chemical and smoke units if it is not clear in task organization. Establish priorities of work if not addressed in unit SOPs.

**(g) Provost Marshall.** Annex K (PM). Clearly state any reconnaissance or surveillance task needed to support ISR operations. Assign priorities of effort and support. Establish priorities of support to enemy prisoner of war (EPW) operations.

**(h) Civil-Military Operations.** Refer to annex Q if used.

**d. Coordinating instructions.**

**(1) Time or condition.** List when a plan or an order becomes effective.

**(2) Requirements.**

**(a) Priority intelligence requirements.** List the reconnaissance and surveillance tasks, NAIs, and LTIOV of the PIRs.

**(b) Friendly forces information requirements.**

**[Classification]**

**Figure G-22. Annex L (Intelligence, Surveillance, and Reconnaissance) Instructions and Format (continued)**

## [Classification]

**ANNEX L (INTELLIGENCE, SURVEILLANCE, AND RECONNAISSANCE) TO OPERATION ORDER NO## [code name]—[issuing headquarters]****(c) Intelligence requirements.**

**(3) Risk reduction control measures.** These are measures unique to this operation and not included in unit SOPs and can include mission-oriented protective posture, operational exposure guidance, troop-safety, vehicle recognition signals, and fratricide prevention measures.

**(4) Intelligence coordination measures.** These measures include the area of intelligence responsibility, intelligence coordination line/lines, intelligence liaison measures, and special security office arrangements and coordination that effect ISR operations.

**(5) Rules of engagement (ROE).** Refer to annex E (Rules of Engagement) if required. Include special considerations such as Intelligence Oversight and United States SIGINT Directives (USSID).

**(6) Environmental considerations.****(7) Force protection.****(8) Common collection requirements.**

**(9) Any additional coordinating instructions.** List scheduled times for linkups and rehearsals.

**4. SERVICE SUPPORT.** State any support requirements (CASEVAC, conventional maintenance, IEW maintenance support required by any non-organic ISR assets operating within a maneuver unit's AOR). Refer to annexes, if required. Subparagraphs can include:

**a. Support concept.** State the concept of logistics support to ISR operation. This could include—

- The support concept organized into a framework based on ISR phasing, or presented as before, during, and after operations format.
- A brief synopsis of the support command mission.
- Support command headquarters or support area locations, including locations of the next higher logistic bases if not clearly conveyed in the CSS overlay.
- The commander's priorities of support.
- Units in the next higher CSS organization supporting the unit.
- The use of HN support.
- Significant or unusual CSS issues that might impact the overall ISR operation.
- Any significant sustainment risks.
- Unique support requirements in the functional areas of manning, arming, fueling, fixing, moving, and sustaining the soldier and his systems.

**b. Materiel and services.****c. Medical evacuation and hospitalization** (air and ground).

[Classification]

**Figure G-22. Annex L (Intelligence, Surveillance, and Reconnaissance) Instructions and Format (continued)**

<p>[Classification]</p> <p><b>ANNEX L (INTELLIGENCE, SURVEILLANCE, AND RECONNAISSANCE) TO OPERATION ORDER NO## [code name]—[issuing headquarters]</b></p> <p><b>d. Personnel service support.</b></p> <p><b>5. COMMAND AND SIGNAL.</b></p> <p><b>a. Command.</b></p> <p><b>b. Signal.</b></p> <ul style="list-style-type: none"><li>• State to whom to report collected information and on what nets.</li><li>• Outline the retransmission plan to support the operation.</li></ul> <p><b>ACKNOWLEDGE:</b> (if distributed separately from base order).</p> <p style="text-align: right;"><b>[Authenticator's last name]</b> <b>[Authenticator's rank]</b></p> <p><b>APPENDIXES:</b></p> <ol style="list-style-type: none"><li>1. ISR Tasking Plan/Matrix.</li><li>2. ISR overlay.</li></ol> <p><b>DISTRIBUTION:</b> (if distributed separately from base order).</p> <p style="text-align: center;"><b>[Classification]</b></p>
--

Figure G-22. Annex L (Intelligence, Surveillance, and Reconnaissance) Instructions and Format (continued)

<b>[Classification]</b>	
Include heading if annex distributed separately from base OPLAN/OPORD.	
<b>ANNEX M (REAR AREA AND BASE SECURITY) TO OPERATION ORDER NO##</b> <b>[code name]—[issuing headquarters]</b>	
<p><b>1. SITUATION.</b></p> <p><b>2. MISSION.</b></p> <p><b>3. EXECUTION.</b></p> <p style="padding-left: 20px;"><b>a. Scheme of rear area and base security operations.</b> Describe how the rear area and base security operations will support the overall operation.</p> <p style="padding-left: 40px;"><b>(1) Terrain management.</b> Identify areas to be used for reconstitution. State when the rear boundaries will be moved forward.</p> <p style="padding-left: 40px;"><b>(2) Security.</b> Identify the tactical combat force, response force, and reaction forces. Describe the counterreconnaissance plan. State how aviation overflights (routine in support of sustaining operations) will be used to provide additional reconnaissance. Identify CI tasks that support threat reduction, location, and identification. Plan for integrating any HN, multinational, or joint force support.</p> <p style="padding-left: 40px;"><b>(3) Sustainment.</b> Monitor status of sustaining operations. Position support assets. Identify critical CSS facilities and movements that require priority protection. Plan establishment of forward supply points.</p> <p style="padding-left: 40px;"><b>(4) Movements.</b> Monitor administrative and tactical movements in the rear area. Identify choke points that require sustained engineer support. Plan for rerouting sustainment on MSRs to ensure no interference with tactical unit movements. Plan for tracking of all units—including HN, multinational, and joint—moving through the rear area.</p> <p style="padding-left: 20px;"><b>b. Tasks to subordinate units.</b></p> <ul style="list-style-type: none"> <li>• Include tasks for tactical combat forces, military police, and base cluster reaction forces.</li> <li>• Designate responsibilities for specific units to conduct rear area security.</li> <li>• Specify tasks to units for intelligence gathering, liaison, response operations, base and base cluster self-defense, and rear area fire support.</li> <li>• Specify rear CP coordinating tasks for rear area and base security operations.</li> </ul> <p style="padding-left: 20px;"><b>c. Coordinating instructions.</b></p> <p><b>4. SERVICE SUPPORT.</b></p> <p><b>5. COMMAND AND SIGNAL.</b></p> <p style="padding-left: 20px;"><b>a. Command.</b></p> <ul style="list-style-type: none"> <li>• Establish the chain of command for the rear CP. Identify base and base cluster commanders and their chains of command.</li> <li>• Designate the location of the alternate rear CP.</li> </ul>	<div style="border: 1px solid black; padding: 5px;"> <p>See Figure G-11 for general instructions on completing annexes. This figure discusses rear area and base security-specific items.</p> </div>
<b>[Classification]</b>	

Figure G-23. Annex M (Rear Area and Base Security) Instructions and Format

<p>[Classification]</p> <p><b>ANNEX M (REAR AREA AND BASE SECURITY) TO OPERATION ORDER NO##</b> [code name]—[issuing headquarters]</p> <p>b. Signal.</p> <p style="text-align: right;">[Authenticator's last name] [Authenticator's rank]</p> <p><b>APPENDIXES:</b></p> <p><b>DISTRIBUTION:</b> (if distributed separately from base order).</p> <p style="text-align: center;">[Classification]</p>
--

Figure G-23. Annex M (Rear Area and Base Security) Instructions and Format (continued)



**[Classification]**

Include heading if annex distributed separately from base OPLAN/OPORD.

**ANNEX N (SPACE) TO OPERATION ORDER NO## [code name]—[issuing headquarters]**

**1. SITUATION.**

**a. General.** Provide enough information about the overall situation to give subordinate and supporting units a clear understanding of the operations contemplated that require space operations support.

**b. Enemy.** Estimate what the enemy is capable of doing and probably will do with space, air, surface, or subsurface assets to interfere with space operations envisioned in this plan. Refer to annex B (Intelligence) for amplifying information.

**c. Friendly.** Identify all available friendly space forces and assets.

**d. Environment.** In separate subparagraphs list all critical terrain, weather, and civil considerations that would impact space operations. Refer to appropriate annexes as required.

**d. Assumptions.** State assumptions not included in the base plan relating to friendly, enemy, or third-party capabilities that may affect, negate, or compromise space capabilities. If any assumptions are critical to success, indicate alternative COAs.

**2. MISSION.** State the space support mission in support of the operations.

**3. EXECUTION.**

**a. Concept of Operations.** State the general concept of space operations. Briefly describe how they fit into the overall operation, or refer to the base plan. Emphasize aspects of the base plan that require space support and that may affect space capabilities. State OPSEC planning guidance for tasks assigned in this annex. Cross-reference other OPSEC planning guidance for functional areas addressed in other annexes.

**b. Space Activities.** Identify space activities required to support the operation, including the following areas as applicable:

**(1) Communications.** Space operations needed to support communications plans as described in annex H (C4 Operations).

**(2) Environmental.** Meteorological, oceanographic, geodetic, and other environmental support information provided by space assets that affect space, air, surface, and subsurface activities and assets.

**(3) Navigation.** Navigational capabilities that aid transit of ships, aircraft, personnel, or spacecraft and help determine courses and distances traveled and position locations.

**(4) Surveillance.** Information about friendly and enemy forces within or outside the AO that aid in operations and force positioning. Refer to annex B (Intelligence) and annex L (ISR).

**(5) Tactical Warning.** Notification of enemy ballistic missile or space-weapon attacks that can be evaluated from available sensor and intelligence sources and could affect the AO. Refer to annex B (Intelligence).

**[Classification]**

See Figure G-11 for general instructions on completing annexes. This figure discusses space-specific items.

**Figure G-24. Annex N (Space) Instructions and Format**

[Classification]

**ANNEX N (SPACE) TO OPERATION ORDER NO## [code name]—[issuing head-quarters]**

**(6) Space Control.** Space-related activities—whether performed by space, air, or surface assets—that assure friendly forces of unrestricted use of space and space assets, and deny it to enemy forces.

**(7) Nuclear Detonation.** Address notification of detected nuclear detonations that might affect the operation and require evaluation as to weapon yield and location. Refer to annex B (Intelligence).

**(8) Friendly Missile Impact.** Address notification of friendly ballistic missile launches that might affect the AO and that require early warning of affected friendly forces and estimated points of impact. Establish provisions to provide expeditious dissemination of this information throughout the AO.

**(9) Enemy Space Activity.** Address notification of space-related activities undertaken by the enemy that would affect friendly operations. Include notice of enemy space assets observing friendly forces. Include notice of other hostile space activities that deny unrestricted friendly access to space, deny the full capabilities of friendly space assets, or restrict friendly surface resources required by those space assets. Refer to annex B (Intelligence).

**(10) Electronic Warfare.** Identify space activities that support EW. Clearly state the contributions that space systems make to EW. Reference to appendix 4 (EW) to annex P (IO) may be sufficient.

**b. Tasks and Responsibilities.** In separate numbered subparagraphs, assign individual tasks and responsibilities to each subordinate unit, supporting command, or agency that supports the operation. For each task, provide enough detail to assure all essential elements are described properly.

**c. Coordinating Instructions.** Provide guidance common to two or more components, subdivisions, or agencies.

**4. SERVICE SUPPORT.** Provide broad guidance concerning administrative and logistic support for space operations. Address support of mobile and fixed space assets within the theater, or refer to the appropriate annex. Reference to annex I (Service Support) may suffice.

**5. COMMAND AND SIGNAL.**

**a. Command.** Indicate any difference between command channels for space operations and command relationships established in annex A (Task Organization). If applicable, state requirements for headquarters augmentation with space operations personnel. Refer to the appropriate sections of annex H (C4) or the base plan for general C2 support of space activities.

**b. Signal.** Summarize requirements for general C4 support of space activities. Refer to appropriate sections of annex H (C4 Operations).

[Classification]

Figure G-24. Annex N (Space) Instructions and Format (continued)

<b>[Classification]</b>
<b>ANNEX N (SPACE) TO OPERATION ORDER NO## [code name]—[issuing head- quarters]</b>
<b>ACKNOWLEDGE:</b> (If distributed separately from base order.)
<b>[Authenticator's last name]</b> <b>[Authenticator's rank]</b>
<b>APPENDIXES:</b>
<b>DISTRIBUTION:</b> (If distributed separately from base order.)
<b>[Classification]</b>

Figure G-24. Annex N (Space) Instructions and Format (continued)

<b>[Classification]</b>
Include heading if annex distributed separately from base OPLAN/OPORD.
<b>ANNEX O (ARMY AIRSPACE COMMAND AND CONTROL) TO OPERATION ORDER NO## [code name]—[issuing headquarters]</b>
<b>1. SITUATION.</b> Include information affecting A2C2 that is not included in paragraph 1 of the base order and annex G (Air Defense), or that requires expansion.
<b>a. Enemy forces.</b>
(1) List known and templated ADA locations and enemy air corridors.
(2) List significant enemy maneuver capabilities that affect A2C2 operations.
<b>b. Friendly forces.</b> Note additional airspace users—including Air Force, Navy, Marine, coalition ADA, FA, and UAV—that affect the scheme of maneuver.
<b>c. Environment.</b> In separate subparagraphs list all critical terrain, weather, and civil considerations that would impact A2C2 operations. Refer to appropriate annexes as required.
<b>2. MISSION.</b>
<b>3. EXECUTION.</b>
<b>a.</b> None.
<b>b.</b> None.
<b>c. Coordinating instructions.</b>
• Identify routes and corridors (such as minimum-risk routes, low-level transit routes, standard-use routes, unmanned aerial vehicle (UAV) operating areas, restricted operations zones, Air Force routes, and coordination requirements).
• Identify fire support coordination measures that affect airspace users.
• List areas of large area smoke operations.
<b>4. SERVICE SUPPORT.</b>
<b>5. COMMAND AND SIGNAL.</b>
<b>ACKNOWLEDGE:</b> (if distributed separately from base order).
<b>[Authenticator's last name]</b> <b>[Authenticator's rank]</b>
<b>APPENDIXES:</b>
<b>DISTRIBUTION:</b> (if distributed separately from base order).
<b>[Classification]</b>

See Figure G-11 for general instructions on completing annexes. This figure discusses A2C2-specific items.

Figure G-25. Annex O (Army Airspace Command and Control) Instructions and Format

<b>[Classification]</b>	
<p>Include heading if annex distributed separately from base OPLAN/OPORD.</p> <p><b>ANNEX P (INFORMATION OPERATIONS) TO OPERATIONS ORDER NO## [code name]—[issuing headquarters]</b></p> <p><b>1. Situation</b></p> <p><b>a. Enemy.</b> Describe how, when, where, and why the enemy force will operate in the information environment. Describe likely objectives and activities. Identify how information systems will be employed and to what extent the enemy will conduct deliberate, coordinated operations to affect the information environment. Describe populace and third party perceptions, awareness and understand. Refer to annex B (Intelligence) as required.</p> <p>(1). Enemy IO capabilities.</p> <p>(a.) Identify enemy IO elements. Describe the enemy's decision-making structure and characteristics. Identify decision-makers and their personal attributes.</p> <p>(b) Identify enemy vulnerabilities.</p> <p>(c) Identify enemy capabilities to degrade friendly C2. List assets, systems, and functions required by the enemy force to execute its mission.</p> <p>(d) Identify the enemy situation, force disposition, intelligence elements and possible actions. Identify those aspects of the information environment that favor the enemy.</p> <p>(e) Identify specific information that bears directly on the planned IO.</p> <p><b>b. Friendly.</b></p> <p>(1) Identify friendly forces IO capabilities. to operate in the information environment.</p> <p>(2) Identify IO assets needed to attack enemy targets.</p> <p>(3) Identify the friendly forces that will directly affect IO.</p> <p>(4) Identify the critical limitations of planned IO.</p> <p>(5) Identify potential conflicts within the friendly electromagnetic spectrum especially if conducting joint or multinational operations. Identify, deconfliction methods and priority of spectrum distribution.</p> <p>(6) Address each IO element's capabilities and vulnerabilities in separate subparagraphs.</p> <p>(7) List constraints on friendly IO.</p> <p>(8) Identify friendly vulnerabilities to enemy and third party actions in the information environment.</p> <p><b>c. Environment.</b></p> <p><b>(1) Terrain.</b> Refer to annex F (Engineer) as required. Describe and identify significant terrain that affects IO.</p> <p><b>(2) Weather.</b> Refer to annex B (Intelligence) as required. List weather aspects that affect each IO element.</p> <p><b>(3) Civil Considerations.</b> Refer to annex Q (Civil-Military Operations) as required.</p> <p><b>(a)</b> Identify key people, organizations, and groups in the AO that will operate in the information environment to affect friendly and enemy operations.</p>	<p>See Figure G-11 for general instructions on completing annexes. This figure discusses IO-specific items.</p>
<b>[Classification]</b>	

Figure G-26. Annex P (Information Operations) Instructions and Format

**[Classification]**

(b) Describe likely objectives and activities of these key people, organizations, and groups in the AO that will affect IO.

**d. Information Environment.** Identify significant characteristics of the information environment to include the following:

- (1) Populace, and civil infrastructure.
- (2) Information content, flow, and distribution.
- (3) Populace and third party perceptions, awareness and understanding.
- (4) Identify those aspects of the information environment that favor all other persons on the battlefield.

**e. Attachments and Detachments.** List IO assets that are attached or detached. List IO resources available from higher headquarters.

**2. MISSION.** State the mission of IO in support of the operation.

**3. EXECUTION.**

**a. Concept of Support.**

- (1) Describe the IO concept of support. This is a clear, concise statement of where, when, and how the commander intends to focus information operations and how it supports the commanders intent. A complex IO concept of support may require a schematic to show IO objective–IO task relationships.
- (2) Describe the IO objectives. These are clearly defined, obtainable effects that the commander intends to achieve using IO elements/related activities.
- (3) Describe IO tasks. These are tasks developed to support accomplishment of one or more IO objectives. Sequence key tasks by phase.
- (4) Place details of each IO element in a separate subparagraph. Use appendixes if necessary.
- (5) Explain how IO will help achieve information superiority at the operations decisive points.
- (6) Refer to appendix 5 (IO Execution Matrix) to annex P to clarify the timing relationships among IO tasks.
- (7) Use other annexes and appendixes as necessary.
- (8) Place details in element subparagraphs that describe each element’s role and priorities in information operation.

**(a) Operations Security.** State how OPSEC tasks will deny the enemy knowledge of the EEFI of the operation. Synchronize this element with the other IO elements. Refer to appendix 1, Operations Security, for detailed information.

**(b) Psychological Operations.** State how the PSYOP tasks will degrade, disrupt, deny, or influence the enemy to support the accomplishment of the operation. Identify the audiences and desired effects, in priority, for PSYOP to support the commander’s intent. Synchronize this element with the other IO elements. Refer to appendix 2 (PSYOP) for detailed information.

**(c) Military Deception.** State how the MILDEC tasks will deceive and influence the enemy. State how MILDEC support accomplishment of the operation. Synchronize this element with the other IO elements. Refer to appendix 3 (Military Deception) for detailed information.

**(d) Electronic Warfare.** State how the EW tasks will degrade, disrupt, deny, and deceive the enemy. State the defensive and offensive EW measures.

**[Classification]**

**Figure G-26. Annex P (Information Operations) Instructions and Format (continued)**

**[Classification]**

Identify target sets and effects, by priority, for EW operations. State how EW supports accomplishment of the operation. Synchronize this element with the other IO elements. Refer to appendix 4 (Electronic Warfare) for detailed information.

**(e) Computer Network Operations.** For echelons above corps or a corps/division designated as a JTF, stating CNO requirements is appropriate. For a corps or lower echelon unit that is not designated as a JTF, CNO is not appropriate. In the case of a JTF, the CNO paragraph or appendix states CNO tasks in terms of CNA, CND, and CNE (as in the following paragraphs).

**(f) Computer Network Attack.** State how the CNA tasks will destroy, degrade, disrupt, and deny the enemy. Identify target sets and effect, by priority, for CNA. If appropriate, state how CNA supports accomplishment of the operation. Synchronize this element with the other IO elements. Pass request for CNA to higher headquarters for approval and implementation.

**(g) Computer Network Defense.** State how CND will protect and defend computer networks. State how CND supports accomplishment of the operation. Synchronize this element with the other IO elements. Refer to annex H, Command, Control, Computer, and Communications, for detailed information.

**(h) Computer Network Exploitation.** For echelons above corps or a corps/division designated as a JTF, stating CNE requirements is appropriate. For a corps or lower echelon unit that is not designated as a JTF, CNE is not appropriate. In the case of a JTF, the CNE paragraph or appendix states the CNE tasks. Synchronizes CNE with other IO elements. Pass requests for CNE to higher headquarters for approval and implementation.

**(i) Physical Destruction.** State how the physical destruction tasks will destroy, degrade, disrupt, and deny the enemy. Identify target sets and effects, by priority, for physical destruction. State how physical destruction used in the IO role supports accomplishment of the operation. Synchronize this element with the other IO elements. Refer to annex D (Fire Support) for detailed information.

**(j) Information Assurance.** State how the IA tasks will deny the enemy access to the friendly C2 system. Identify the information and INFOSYS for protection. State how IA supports accomplishment of the operations. Synchronize this element with the other IO elements. Refer to annex H (Command, Control, Computer, and Communications) for detailed information.

**(k) Physical Security.** State how the physical security tasks will deny the enemy information about the command. The state of the physical security needs to support IO. Synchronize this element with other IO elements. Refer to annex K (Provost Marshal) for detailed information.

**(l) Counterintelligence.** State how the counterintelligence tasks will degrade, disrupt, deny, and exploit the enemy. Identify the units for protection. State how CI supports the core elements of IO in accomplishing the mission. Synchronize this element with the other IO elements. Refer to annex B (Intelligence) for detailed counterintelligence information.

**(m) Counterdeception.** State how the counterdeception tasks will disrupt, deny, and exploit the enemy. Identify the units for protection. State how counterdeception will support the accomplishment of the operation. Synchronize this element with the other IO elements. Refer to annex B (Intelligence) for detailed counterdeception information.

**[Classification]**

**Figure G-26. Annex P (Information Operations) Instructions and Format (continued)**

<b>[Classification]</b>
<p><b>(n) Counterpropaganda.</b> State how the counterpropaganda objectives and counterpropaganda tasks will degrade, disrupt, deny, and exploit the enemy based on the approved COA. Identify the units for protection. Synchronize this element with the other IO elements. Refer to appendix 2 (PSYOP) for detailed counterpropaganda information.</p> <p><b>(o) Civil-Military Operations.</b> CMO is a related activity to IO. State how CMO supports the elements of IO in its concept of support to the operation. State how IO supports the accomplishment of CMO. See annex Q (Civil Military Operations) for detailed information.</p> <p><b>(p) Public Affairs.</b> PA is a related activity to IO. State how PA supports the elements of IO in its concept of support to the operation. State how IO supports the accomplishment of PA. See annex R (Public Affairs) for detailed information.</p> <p><b>b. Tasks to Subordinate Units.</b></p> <ul style="list-style-type: none"> <li>(1) List IO tasks to maneuver units.</li> <li>(2) List IO tasks to PSYOP units.</li> <li>(3) List tasks to EW units.</li> <li>(4) List IO tasks to counterintelligence units.</li> </ul> <p><b>c. Instructions to IO Cell.</b></p> <ul style="list-style-type: none"> <li>(1) List members of IO cell if not covered in SOP.</li> <li>(2) State non-SOP tasks assigned to the IO cell.</li> </ul> <p><b>d. Coordinating Instructions.</b> Include only IO instructions not already covered in the base OPLAN/OPORD common to two or more units. State ROE for each IO element. Do not include SOP information. List constraints not contained in the concept of support.</p> <p><b>4. SERVICE SUPPORT.</b> Identify requirements for supply distribution, transportation, and HN support pertaining to IO as a whole. Identify service support to individual IO elements their respective appendixes or annexes.</p> <p><b>5. COMMAND AND SIGNAL.</b> Significant command and signal information related to IO is normally covered in the body of the order. This paragraph covers arrangements needed to exchange information among IO elements.</p> <p><b>ACKNOWLEDGE:</b> (if distributed separately from base order).</p> <div style="text-align: right; margin-right: 50px;"> <p><b>[Authenticator's last name]</b></p> <p><b>[Authenticator's rank]</b></p> </div> <p><b>APPENDIXES</b> (See FM 3-13 for appendix formats):</p> <ul style="list-style-type: none"> <li>1. Operations Security.</li> <li>2. Psychological Operations.</li> <li>3. Military Deception Plan.</li> <li>4. Electronic Warfare.</li> <li>5. IO Execution Matrix.</li> <li>6. Others as required</li> </ul> <p><b>DISTRIBUTION:</b> (if distributed separately from base order).</p>
<b>[Classification]</b>

**Figure G-26. Annex P (Information Operations) Instructions and Format (continued)**



<b>[Classification]</b>	
<p>Include heading if annex distributed separately from base OPLAN/OPORD.</p> <p><b>ANNEX Q (CIVIL-MILITARY OPERATIONS) TO OPERATION ORDER NO## [code name]—[issuing headquarters]</b></p> <p><b>1. SITUATION.</b></p> <p><b>a. Enemy Forces.</b> State actual/potential nonmilitary threats to the force, the civil populace and government, and to mission accomplishment.</p> <p>Refer to annex B (Intelligence) as required.</p> <p><b>b. Friendly.</b></p> <p>(1). State the CMO concept of higher headquarters.</p> <p>(2). State the CMO concept of adjacent headquarters.</p> <p><b>c. Civil Considerations.</b> Describe the major strengths and vulnerabilities of civil components of the AO and how they relate to the overall mission. Describe the general civil situation in terms of ASCOPE, as analyzed by the CMO Estimate.</p> <p>(1) <b>Areas:</b> Include those key aspects of the commander's battlespace, such as political boundaries, centers of government, open areas for possible temporary settlement, agricultural and mining regions, and other significant geographic and economic features.</p> <p>(2) <b>Structures:</b> Include structures such as cultural sites, facilities with practical applications, jails, warehouses, schools, power plants, water purification plants, radio and TV antennas.</p> <p>(3) <b>Capabilities:</b> An allied or adversaries' ability to provide services (for example, policing, emergency and routine medical services, temporary shelters, public administration, and reestablishing industrial and agricultural capacity).</p> <p>(4) <b>Organizations:</b> Locations and meeting cycles of key international organizations and NGOs, governing bodies, health services, legal and law enforcement, religious groups, fraternal groups, multinational corporations.</p> <p>(5) <b>People:</b> Include key personnel and linkage to the population, leaders, figureheads, clerics, SMEs (sewage plant operators, public utilities), and demobilized soldiers. Cultural information that impacts on the relationship between the populace and military forces.</p> <p>(6) <b>Events:</b> Cycles and seasons (harvest and planting seasons), significant weather events, elections, school year, fiscal year, holidays (religious periods, traditional vacation times).</p> <p><b>d. Attachments and detachments.</b></p> <p><b>2. MISSION.</b> State the mission of CMO in support of the operation.</p> <p><b>3. EXECUTION.</b></p> <p>a. Scheme of CMO. Describe the concept of CMO to support the commander's intent and the maneuver plan. Tie in critical CMO tasks by phase to focus CMO.</p>	
	<p>See Figure G-11 for general instructions on completing annexes. This figure discusses CMO-specific items.</p>
<b>[Classification]</b>	

**Figure G-27. Annex Q (Civil-Military Operations) Instructions and Format**

b. Tasks to subordinate units. List CMO tasks that specific units are to accomplish that the base order does not contain. List CMO tasks that CA units supporting maneuver elements are to accomplish only as necessary to ensure unity of effort.

c. Coordinating Instructions. Place instructions and details of coordination that apply to two or more subordinate units not covered by SOP. This includes CMO policy statements, special reporting procedures, and MOE.

**4. SERVICE SUPPORT.** Include any logistical support not covered in Annex I (Service Support). This can include handling of resources from outside military for use in CMO efforts.

**5. COMMAND AND SIGNAL.**

**a. Command.** Locations of CMO staffs, CMOCs and subordinate and supporting CA unit headquarters.

**b. Signal.** Designate reporting functions for units assigned CMO tasks and CA units.

**ACKNOWLEDGE:** (if distributed separately from base order).

**[Authenticator's last name]**

**[Authenticator's rank]**

**APPENDIXES:**

Include specific diagrams, overlays and plans on each key CMO task if too large for annex base (for example, DC Plan, FHA, or MCA)

1. Cultural study/country study
2. CMO Synchronization Matrix
3. Others

**[Classification]**

Figure G-27. Annex Q (Civil-Military Operations) Instructions and Format (continued)

**[Classification]**

Include heading if annex distributed separately from base OPLAN/OPORD.

**ANNEX R (PUBLIC AFFAIRS) TO OPERATION ORDER NO## [code name]—[issuing headquarters]**

**1. SITUATION.** Include information affecting public affairs (PA) operations not included in the OPLAN/OPORD. Identify the impact of media and news technology on unit ability to complete its mission. Identify any higher and adjacent unit PA plans. Identify PA resources and news media attached and detached with effective times.

**2. MISSION.**

**3. EXECUTION.** State the proposed PA operations. Establish priorities. Define requirements for media liaison, particularly with any foreign news agencies.

**4. SERVICE SUPPORT.**

**5. COMMAND AND SIGNAL.** Designate the reporting functions for PA activities.

**ACKNOWLEDGE:** (if distributed separately from base order).

**[Authenticator's last name]**  
**[Authenticator's rank]**

**APPENDIXES:**

**DISTRIBUTION:** (if distributed separately from base order).

**[Classification]**

See Figure G-11 for general instructions on completing annexes. This figure discusses PA-specific items.

Figure G-28. Annex R (Public Affairs) Instructions and Format

## VII Corps Operation Order Vignette

Figures G-29 and G-30 show Field Order 18, a typical order prepared by Army forces during World War II. Field Order 18 was completed in a time-constrained environment and relied on proven SOPs. It uses the overlay order technique. The commanding general provided additional mission orders personally.

The VII Corps, commanded by MG (later GEN) J. Lawton “Lightning Joe” Collins, had to expand the Remagen Bridgehead as well as plan for the breakout and exploitation into the German industrial heartland. VII Corps prepared, and the commanding general gave, the order verbally on 22 March 1945. A written order—including overlay, intelligence annex, and fire support annex—followed on 23 March. The order, both the verbal and written, was flexible enough to be adapted between its time of issue and execution.

Especially notable is the brevity and simplicity of the base order. Such simplicity and brevity reflect the combat-tested experience and SOPs of VII Corps and the divisions within First US Army. Field Order 18 contains the minimum essential information required in an OPOD today:

- Five basic paragraphs (slightly different from now, but nevertheless similar in name and order).
- Task organization (contained in subparagraphs of paragraph 3 rather than above paragraph 1).
- Mission statement (paragraph 2).
- Operations overlay.

MG Collins used verbal orders and an overlay to issue his order. The written order confirmed those directives. Today a commander’s intent and concept of operations are mandatory. In Field Order 18, a concept is outlined in the subparagraphs of paragraph 3. Presumably, the corps commander issued his concept in the verbal orders. It is apparent from the execution of the operation that the subordinates understood MG Collins’ concept.

D-day and H-hour for Field Order 18 were 0400 hours, 25 March 1945. The corps accomplished its initial objectives on 26 March, seized its objective on 27 March, and exploited to Marburg on 28 March. The corps issued a subsequent field order (Field Order 19) on 28 March for follow-on operations. These eventually involved closing the Ruhr Pocket with XIX Corps from Ninth Army to the north on 1 April 1945, after covering 300 kilometers in seven days. Over 300,000 German soldiers were captured in the pocket. During the European campaign, VII Corps issued only 20 field orders, an average of two per month, to control operations; many of these confirmed verbal orders of CG, VII Corps.

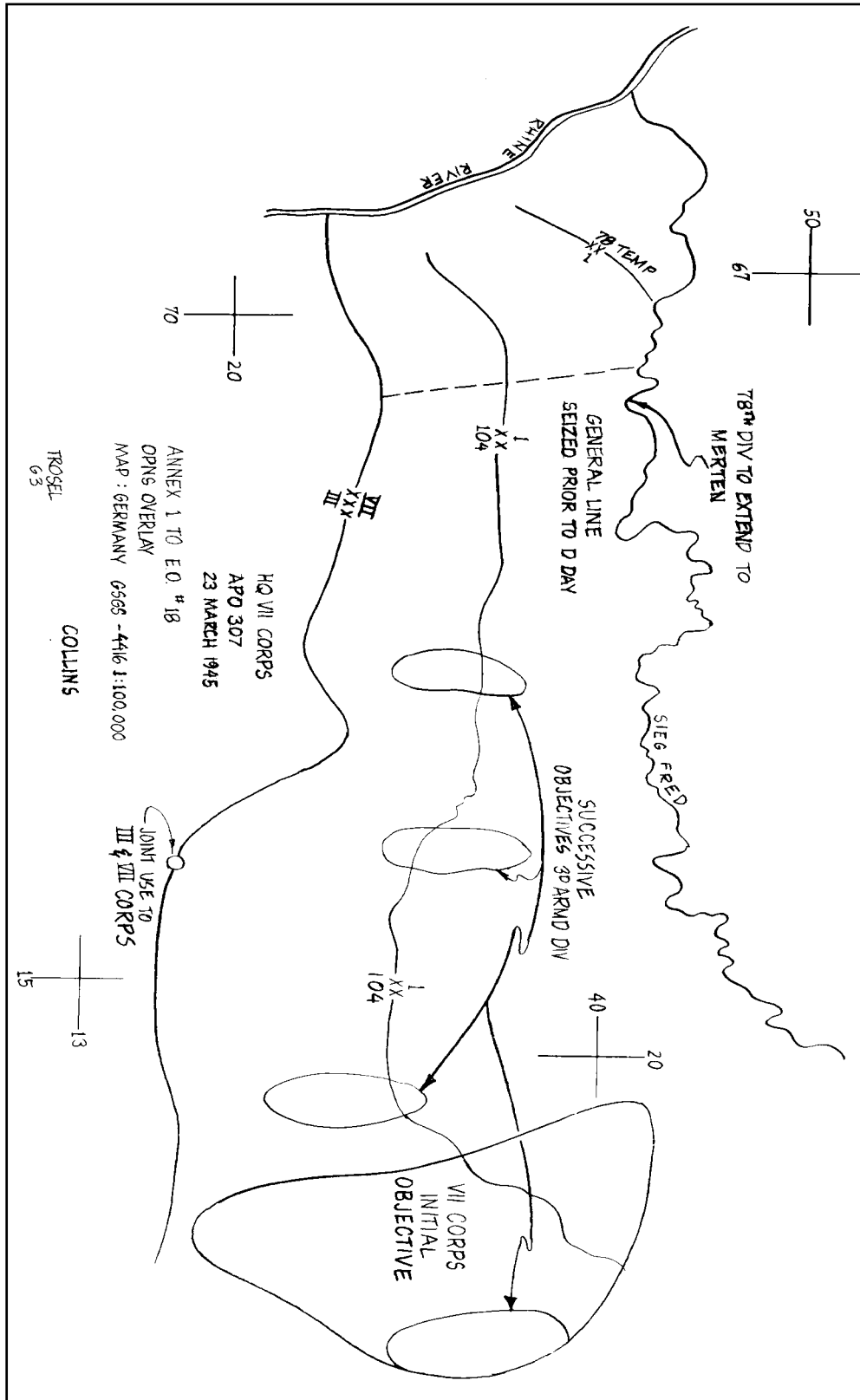

Figure G-29. Overlay to VII Corps Field Order 18, 23 March 1945

HQ, VII CORPS  
APO 307  
23 MARCH 1945

**FO 18 (Confirming verbal orders CG VII Corps issued 22 March 1945)**

Maps: GSGS 4416 CENTRAL EUROPE 1/100,000

1. a. See annex 2, Intelligence.

b. (1) NINTH US ARMY, with XIX Corps on its right, continues its defense of the RHINE River from WORRINGEN (F3874) (excl) to the NORTH.

(2) FIRST US ARMY will attack on D-day from present bridgehead area to drive EAST between the SIEG River on the NORTH and the LAHN River on the SOUTH to capture the road center at LIMBURG (M2398), and the high ground extending generally NORTH thereof.

2. a. VII Corps will (1) attack at H-hour, D-day within zone of action EAST of the RHINE and SOUTH of the SIEG River to capture the high ground generally WEST of the DILL River between WURGENDORF (G2740) and NENDEROTH (G3220); (2) be prepared to resume the attack to the NORTHEAST; (3) maintain defense of the WEST bank of the RHINE in the Corps zone and NORTH of BONN (F5537); and (4) protect the left flank of the FIRST ARMY EAST of the RHINE.

b. For Corps and Division boundaries and initial objectives, see annex 1, Operations Overlay.

c. H-hour and D-day to be announced.

3. a. 3d Armored Division, Major General Maurice Rose, Commanding.

(1) Attachments:

- 414th Inf (104th Inf Div)
- 183d FA Bn (155 How)
- 83d Armd FA Bn (105 How SP)
- 486th AAA AW Bn (SP)
- 703d TD Bn (SP)

NOTES:

MG Collins used verbal and overlay techniques for delivering the order.

1. Annex 2 not included; consisted of main body (3 pages) and 2 appendixes: App 1, Counterintelligence (2 pages); App 2, Tactical Study of the Terrain (2 pages).

2. MISSION

Operation commenced 250400 MAR 1945 following crossing of Rhine to north by 21 Army Group. Technically this is an OPLAN IAW current doctrine (see Operations Overlay.)

Doctrinal location (1944) for task organization (between paragraphs 2 and 3).

In this case, task organizations are included in paragraph 3 for subordinate units.

3. TACTICAL MIS-SIONS FOR SUBORDINATE UNITS.

Implied concept: 3AD pass through IDs; seize Corps objectives in order. Initial objectives taken 2d day, DILL River crossed on 3d day.

Figure G-30. VII Corps Field Order 18, 23 March 1945

<p>(2) Will attack H-hour D-day through elements of the 104th Division and 1st Inf Div and advance rapidly to seize initially the high ground and road center in the vicinity of ALTENKIR-CHEN (F9332) and successive objectives thereafter to include crossings of the DILL River between DILLENBURG (G3837) and HERBORN (G3931). Will by-pass [sic] pockets of resistance in order to seize objectives quickly. Will be prepared to exploit in the direction of MARBURG (G7347) - FRANKENBERG (G7473).</p> <p>b. 104th Infantry Division, Major General Terry Allen, Commanding.</p> <p>(1) Attachments:</p> <ul style="list-style-type: none"><li>555 AAA AW Bn (M)</li><li>750th Tk Bn</li><li>Co. C, 644th TD Bn (SP)</li></ul> <p>(2) With its principal effort on the left, will attack at H-hour on D-day to eliminate all enemy resistance within its zone of action.</p> <p>(3) Will assist the advance of 3d Armd Div.</p> <p>c. 1st Infantry Division, Brigadier General Clifton Andrus, Commanding.</p> <p>(1) Attachments:</p> <ul style="list-style-type: none"><li>957th FA Bn (155 How)</li><li>193d FA Bn (25 Pdr)</li><li>103d AAA AW Bn (M)</li><li>634th TD Bn (SP)</li><li>745th Tk Bn</li><li>Co A, 86th Cml Bn</li></ul> <p>(2) With its principal effort on the right, will attack at H-hour on D-day to eliminate all enemy resistance within its zone of action.</p>	<p>See next two subparagraphs: Infantry divisions following to clear enemy forces.</p> <p>VII Corps/3 AD exploited to MARBURG on 4th day.</p>
---	---

Figure G-30. VII Corps Field Order 18, 23 March 1945 (continued)

(3) Will assist the advance of 3d Armd Div.

(4) Will protect the NORTH flank of the Corps within its zone.

(5) Will be progressively relieved of responsibility for protecting the NORTH flank of the Corps by elements of 78th Inf Div and the 4th Cav Gp per par 3d(3) and par 3g below.

d. 78th Infantry Division, Major General Edwin P. Parker, Jr., Commanding.

(1) Attachments:

76th FA Bn (25 Pdr)

893d TD Bn (SP)

774th Tk Bn

552d AAA AW Bn (M)

Co B, 86th Cml Bn

(2) Will protect the left flank of the Corps along the SIEG from the RHINE River to the EAST, relieving elements of the 1st Inf Div along the SIEG River initially as far as MERTEN (F7640) as the attack of the 1st Inf Div progresses.

e. 8th Infantry Division, Brigadier General Bryant E. Moore, Commanding.

(1) Attachments:

69th Div Arty (-879th FA Bn (105 How))

445th AAA AW Bn (M)

644th TD Bn (SP) (-Co C)

(2) Will continue to secure the WEST bank of the RHINE River between F383754 and F535410, preventing the passage of any enemy across the river and maintaining observation over the entire sector.

(3) Will be relieved by 86th Inf Div and assemble in Corps reserve on order CG VII Corps.

f. 86th Infantry Division, Major General Harris M. Melasky, Commanding.

Will relieve 8th Inf Div in its zone and take over the mission of securing the WEST bank of the RHINE River in its zone, preventing the passage of any enemy across the river and maintaining observation over the entire sector.

g. 4th Cavalry Group, Colonel John C. McDonald, Commanding.

Figure G-30. VII Corps Field Order 18, 23 March 1945 (continued)



(1) Attachments:

4th Cav Sq  
24th Cav Sq  
759th Lt Tk Bn (-Co B)  
Co A, 298th Engr C Bn

(2) Will assemble by 25 March in vicinity of BONN (F5537) in corps reserve. (3) Will be prepared to defend the NORTH flank of the Corps along the SIEG River EAST of MERTEN (F7640) on order CG VII Corps, progressively relieving elements of 1st Inf Div as the attack advances.

h. VII Corps Artillery.

VII Corps Artillery will support the attack as per annex 3, Artillery.

i. VII Corps Engineers.

Corps Engineer troops support the operation; 1120th Engr C Gp in the zone of 104th Inf Div with one battalion in support of the Div; 1106th Engr C Gp in the zone of 1st Inf Div with one battalion in support of 1st Inf Div and one battalion in support of 3d Armd Div.

j. Air Support will be provided for the operation by fighter-bombers and medium bombers of IX TAC and IX Bomb Div of NINTH AIR FORCE.

(1) No vehicles will be parked on main roads at any time.

(2) Commanders will insure that main traffic routes are cleared of road blocks and rubble and that important traffic is not impeded by halted columns.

4. Administrative Orders 114, 115, and 116.

5. a. (1) Current SOI.

b. Initial Command Posts:

VII Corps KONIGSWINTER (F617310)  
1st Inf Div F658307  
8th Inf Div WEIDEN (F362606)  
78th Inf Div NDR HOLTORF (F610375)  
86th Inf Div to be reported.  
104th Inf Div HONNEF (F649272)  
3d Armd Div HONNEF (F649272)  
4th Cav Gp BONN (F553372)

/s/ J. Lawton Collins

/t/ J. LAWTON COLLINS

Major General, U.S. Army,  
Commanding

4. ADMINISTRATIVE  
Orders included Supply,  
Evacuation, Traffic,  
Service Troops and  
Trains, Personnel, and  
miscellaneous  
paragraphs.

Figure G-30. VII Corps Field Order 18, 23 March 1945 (continued)



## Appendix H

# Integrating Targeting into the Operations Process

This appendix discusses integrating the targeting process into the operations process with emphasis on planning. It is organized around the four targeting functions: decide, detect, deliver, assess (see Figure H-1, page H-2). It discusses the decide function in terms of military decision making process tasks. Refer to FM 6-20-10 for targeting process details and examples of targeting products. Refer to FM 3-13 for integrating information operations targeting into both processes.

## TARGETING PROCESS AND TARGETING TEAM

H-1. Targeting is a logical process that synchronizes fires with the effects of other battlefield operating systems. It is an integral part of Army operations. Based on the commander's targeting guidance and targeting objectives, the targeting team determines what targets to attack and how, where, and when to attack them. It then assigns targets to systems best suited to achieve the desired effects. The chief of staff/executive officer normally leads the targeting team. Fire support, G2, G3, G7, and Air Force representatives form its core. Other coordinating and special staffs participate, as their functional areas require.

H-2. The *decide* function occurs concurrently with planning. The *detect* function occurs during preparation and execution. The *deliver* function occurs primarily during execution, although some targets may be engaged while the command is planning or preparing for the overall operation. The *assess* function occurs throughout the operations process, but is most intense during execution.

H-3. The targeting process is cyclical. The battle rhythm of the command determines when the targeting team meets. Figure H-2 shows an example of a targeting team schedule that meets a command's battle rhythm.

<b>CONTENTS</b>	
<b>Targeting Process and Targeting Team</b>	
<b>Team</b> .....	<b>H-1</b>
<b>Decide</b> .....	<b>H-2</b>
<b>Mission Analysis</b> .....	<b>H-3</b>
<b>Course of Action Development</b> .....	<b>H-4</b>
<b>Course of Action Analysis</b> .....	<b>H-5</b>
<b>COA Comparison and Approval and Orders Production</b> .....	<b>H-6</b>
<b>Detect</b> .....	<b>H-6</b>
<b>Deliver</b> .....	<b>H-7</b>
<b>Assess</b> .....	<b>H-7</b>

	Operations Process Activity	Targeting Process Activity	Targeting Task
<b>ASSESSMENT</b>	<b>PLANNING</b>	<b>DECIDE</b>	<p><b>Mission Analysis</b></p> <ul style="list-style-type: none"> <li>• Perform TVA to develop HVTs</li> <li>• Develop targeting guidance and targeting objectives</li> </ul> <p><b>COA Development</b></p> <ul style="list-style-type: none"> <li>• Designate potential HPTs</li> <li>• Deconflict and coordinate potential HPTs</li> </ul> <p><b>COA Analysis</b></p> <ul style="list-style-type: none"> <li>• Develop HPTL</li> <li>• Establish TSS</li> <li>• Develop AGM</li> <li>• Determine criteria of success BDA requirements</li> </ul> <p><b>Orders Production</b></p> <ul style="list-style-type: none"> <li>• Finalize HPTL</li> <li>• Finalize TSS</li> <li>• Finalize AGM</li> <li>• Submit IRs/RFIs to G2</li> </ul>
			<b>PREPARATION EXECUTION</b>
	<b>DELIVER</b>	<ul style="list-style-type: none"> <li>• Execute attacks in accordance with the AGM</li> <li>• Execute information operations tasks</li> </ul>	
			<b>ASSESS</b>

**Figure H-1. Targeting Process Activities and Tasks**

## DECIDE

H-4. The *decide* function is part of the planning activity of the operations process. It occurs concurrently with the military decision making process (MDMP). During the decide function, the targeting team focuses and sets priorities for intelligence collection and attack planning. Based on the commander’s intent and concept of operations, the targeting team establishes targeting priorities for each phase or critical event of an operation. The following products reflect these priorities:

- **High-payoff Target List.** The high-payoff target list (HPTL) is a prioritized list of targets whose loss to the threat will contribute to the success of the friendly course of action (COA).
- **Intelligence Synchronization Plan.** The plan the intelligence officer uses, with staff input, to synchronize the entire collection effort to include all assets the commander controls, assets of lateral units,

and higher echelon units and organizations, and intelligence reach to answer the commander’s critical information requirements (CCIR).

- **Target Selection Standards.** Target selection standards (TSS) establish criteria for deciding when targets are located accurately enough to attack.
- **Attack Guidance Matrix.** The attack guidance matrix (AGM) lists which targets or target sets to attack, how and when to attack them, and the desired effects.
- **Target Synchronization Matrix.** The target synchronization matrix (TSM) combines data from the HPTL, intelligence synchronization plan and AGM. It lists HPTs by category and the agencies responsible for detecting them, attacking them, and assessing the effects of the attacks.

The targeting team develops or contributes to these products throughout the MDMP. The commander approves them during COA approval.

**MISSION ANALYSIS**

H-5. The major targeting-related products of mission analysis are high-value targets (HVTs) and the commander’s targeting guidance. HVTs are identified during intelligence preparation of the battlefield (IPB).

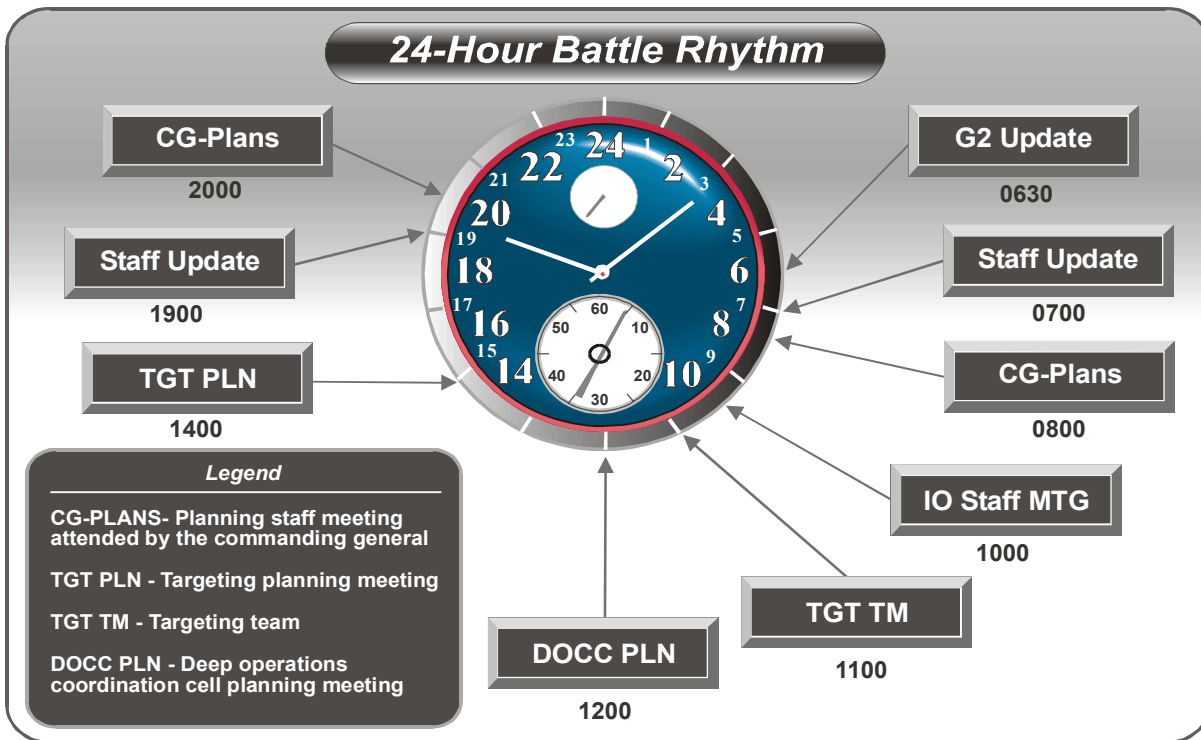

Figure H-2. Targeting and Battle Rhythm Sample

## Intelligence Preparation of the Battlefield

H-6. IPB includes preparing threat models that portray adversary forces and assets unconstrained by the environment. The G-2 adjusts threat models based on terrain and weather to create situational templates that portray possible adversary COAs. A complete threat model identifies HVTs and the situation template predicts the location of the HVT assets that the threat commander requires for the successful completion of a specific COA. The process that identifies HVTs is target value analysis (TVA).

## Target Value Analysis

H-7. TVA yields HVTs for each enemy COA. The targeting team performs TVA for each enemy COA the G-2 develops. The initial TVA sources are target spreadsheets and target sheets.

- **Target Spreadsheets.** Target spreadsheets identify target sets associated with adversary functions that could interfere with each friendly COA or that are key to adversary success. The fire support element usually prepares them.
- **Target Sheets.** A target sheet contains the information required to engage a target. It is a locally produced product. Target sheets state how attacking the target would affect the adversary operation.

## Targeting Guidance

H-8. The commander's guidance, issued at the end of mission analysis, includes targeting guidance. Targeting guidance describes the desired effects of lethal and nonlethal fires. It is expressed in terms of targeting objectives (limit, disrupt, delay, divert, or destroy) or IO effects (destroy, degrade, disrupt, deny, deceive, exploit, or influence). Targeting guidance focuses on essential adversary capabilities and functions, such as, the ability to exercise command and control (C2) of forward units, mass artillery fires, or (in stability operations) form a hostile crowd.

## COURSE OF ACTION DEVELOPMENT

H-9. During COA development, the staff prepares feasible COAs that integrate the effects of all elements of combat power to accomplish the mission. The targeting team identifies which HVTs are potential HPTs for each COA. It coordinates and deconflicts targets and establishes assessment criteria.

## COURSE OF ACTION ANALYSIS

H-10. COA analysis (war-gaming) is a disciplined process that staffs use to visualize the flow of a battle. During the war game, the staff decides or determines—

- Which HVTs are HPTs for each COA. When listed in priority, the HPTs for the approved COA compose the HPTL.
- When to engage each HPT.
- Which system to use against each HPT.

- The desired effects of each attack, expressed in terms of the targeting objectives.
- Which HPTs require BDA.
- Which HPTs require special instructions or require coordination.

H-11. Based on the war game, the targeting team produces the following draft targeting products for each COA:

- HPTL.
- TSS.
- AGM.

### High-Payoff Target List

H-12. The HPTL is a prioritized list of HPTs. A *high-payoff target* is a target whose loss to the threat will contribute to the success of the friendly course of action (FM 6-20-10). During the war game, the staff determines which HVTs are HPTs for each COA. HPTs are critical to both the adversary's needs and the friendly concept of operations. They support achieving the commander's intent and executing the concept of operations. They are determined based on the commander's targeting guidance.

### Target Selection Standards

H-13. TSS are criteria applied to adversary activity (acquisitions or combat information) to decide whether the activity can be engaged as a target. TSS are usually disseminated as a matrix that includes:

- **HPT.** This refers to the designated HPTs that the collection manager is tasked to acquire.
- **Timeliness.** Valid targets are reported to attack systems within the designated timeliness criteria.
- **Accuracy.** Valid targets must be reported to the attack system meeting the required target location error (TLE) criteria. The criteria is the least restrictive target location error considering the capabilities of available attack systems.

H-14. Military intelligence analysts use TSS to determine targets from combat information and pass them to fire support elements for attack. Attack systems managers, such as fire control elements and fire direction centers, use TSS to determine whether to attack a potential target. The G-2 and fire support coordinator determine TSS.

### Attack Guidance Matrix

H-15. The targeting team recommends attack guidance based on the results of the war game. Attack guidance is normally disseminated as a matrix (the AGM). An AGM includes the following information, listed by target set or HPT:

- Timing of attacks (expressed as immediate, planned, or as acquired).
- Attack system assigned.
- Attack criteria (expressed as neutralize, suppress, harass, or destroy).
- Restrictions or special instructions.

H-16. Only one AGM is produced for execution at any point in the operation; however, each phase of the operation may have its own matrix. To synchronize lethal and nonlethal fires, all lethal and nonlethal attack systems, including psychological operations and electronic attack, are placed on the AGM. The AGM is a synchronization and integration tool. It is normally included as part of the fire support annex. However, it is not a tasking document. Attack tasks for unit assets are identified as taskings to subordinate units and agencies in the body or appropriate annexes or appendixes of the operations plan (OPLAN) or operations order (OPORD).

### **Target Synchronization Matrix**

H-17. The TSM lists HPTs by category and the agencies responsible for detecting them, attacking them, and assessing the effects of the attacks. It combines data from the HPTL, intelligence collection plan, and AGM. A completed TSM allows the targeting team to verify that assets have been assigned to each targeting process task for each target. The targeting team may prepare a TSM for each COA, or may use the HPTL, TSS, and AGM for the war game and prepare a TSM for only the approved COA.

### **COA COMPARISON AND APPROVAL AND ORDERS PRODUCTION**

H-18. After war gaming all COAs, the staff compares them and recommends one to the commander for approval. When the commander approves a COA, the targeting products for that COA become the basis for targeting for the operation. The targeting team meets to finalize the HPTL, TSS, AGM, and input to the intelligence collection plan. The team also performs any additional coordination required. After accomplishing these tasks, targeting team members ensure that targeting factors that fall within their functional areas are placed in the appropriate part of the plan or order.

### **DETECT**

H-19. The *detect* function involves locating HPTs accurately enough to engage them. It primarily entails execution of the intelligence collection plan. Although the G-2 oversees the execution of intelligence collection plan, the collection assets themselves do not all belong to the G-2. All staff agencies are responsible for passing to the G-2 information answering information requirements that their assets collect. Conversely, the G-2 is responsible for passing combat information and intelligence to the agencies that identified the information requirements. Sharing information allows timely evaluation of attacks and development of new targets. Effective information management is essential.

H-20. The intelligence collection plan focuses on identifying HPTs and answering PIR. These are prioritized based on the importance of the target or information to the concept of operations and commander's intent. Thus, there is some overlap between the *detect* and *assess* functions. Detecting targets for nonlethal attacks may require intelligence, surveillance, and reconnaissance (ISR) support from higher headquarters. The targeting team adjusts the HPTL and AGM to meet changes as the situation develops.



## DELIVER

H-21. The *deliver* function involves engaging targets located within the TSS according to the guidance in the AGM. HPTs that are located within the TSS are tracked and engaged at the time designated in the order/AGM. Other collection assets look at HPTs that are not located accurately enough or for targets within priority target sets. When one of these is located within the TSS, its location is sent to the system that the AGM assigns to attack it. Not all HPTs will be identified accurately enough before execution. Some target sets may not have very many targets identified. Collection assets and the intelligence system develop information that locates or describes potential targets accurately enough to engage them. The HPTL sets the priority in which they accomplish this task.

## ASSESS

H-22. Assessment occurs throughout the operations process. Targets are attacked until the effects outlined in the AGM are achieved or until the target is no longer within the TSS. (See FM 6-20-10.)



## Appendix I

# Joint Planning

I-1. Joint planning is focused at the strategic- and operational-levels of war. While corps and below Army units normally conduct Army tactical planning, Army forces frequently participate in or conduct joint operations planning. For example, Army service component commands (ASCCs) routinely participate in joint operation planning, to include developing plans as the joint force land component. Corps and divisions perform joint operations planning when serving as a joint task force (JTF) or ARFOR headquarters. Corps, divisions, and brigades, directly subordinate to a JTF, participate in joint operations planning and receive joint-formatted orders. It is important that Army leaders serving in headquarters above battalion understand the joint planning process and are familiar with the joint format for plans and orders.

I-2. This appendix provides an overview of joint operation planning, instruction for preparing a joint operation plan (OPLAN), and a list of joint OPLAN annexes, appendices, and tabs. (See CJCSM 3122.03A, JP 5-0, JP 5-00.1, and JP 5-00.2 for additional guidance on joint operations planning and preparation of joint plans and orders.)

### JOINT PLANNING OVERVIEW

I-3. Joint operation planning directs the military strategic use of military forces to attain specified objectives for possible contingencies. Joint operation planning is conducted through the chain of command, from the President and Secretary of Defense to combatant commanders, and is the primary responsibility of the Chairman of the Joint Chiefs of Staff and combatant commanders.

I-4. Joint operation planning includes the preparation of operation plans (OPLANs), concept plans (CONPLANs), functional plans, campaign plans, and operation orders by joint force commanders. Joint operation planning encompasses the full range of activities required for conducting joint operations, to include the following:

CONTENTS	
Joint Planning Overview .....	I-1
Joint Planning Concepts .....	I-2
Types of Joint Planning.....	I-2
Types of Joint Plans .....	I-3
Joint Operation Plan Format.....	I-4

- **Mobilization Planning.** Primarily a responsibility of the Services, mobilization planning assembles and organizes national resources to support national objectives in times of war and in military operations other than war.
- **Deployment Planning.** Deployment planning is the responsibility of the combatant command in close coordination with US Transportation Command.

- **Employment Planning.** Employment planning prescribes how to apply force to attain specified military objectives. Employment planning concepts are developed by the combatant commanders through their component commands.
- **Sustainment Planning.** Sustainment planning provides and maintains levels of personnel, materiel, and consumables required to sustain the planned combat activity for the duration of the activity at the desired intensity.
- **Redeployment Planning.** Redeployment planning transfers units, individuals, or supplies deployed in one area to another, to another location in the area, or to the zone of interior (JP 5-0).

## JOINT PLANNING CONCEPTS

I-5. Joint operation planning is an integrated process using similar policy and procedures during war and military operations other than war. It provides orderly and coordinated problem solving and decision making. During peacetime, the process supports the thorough and fully coordinated development of deliberate plans. During crisis, the process is shortened, as necessary, to support the dynamic requirements of changing events. During wartime, the process adapts to accommodate greater decentralization of joint operation planning activities.

I-6. Interoperable planning and execution systems are essential to effective planning for joint operations. Activities of the planning community must be integrated through an interoperable joint system that provides uniform policy, procedures, and reporting structures supported by modern communications and computer systems. The system designed to provide this is the Joint Operations Planning and Execution System (JOPES). Detailed instructions for JOPES is located at the following Chairman Joint Chiefs of Staff Memorandums (CJCSM)—

- CJCSM 3122.01.
- CJSCM 3122.02C.
- CJCSM 3122.03A.
- CJCSM 3141.01.

## TYPES OF JOINT PLANNING

I-7. At the joint level there are three types of planning: deliberate, crisis action, and campaign. Deliberate and crisis action planning (CAP) has distinct processes; campaign planning spans both deliberate and crisis action planning (Figure I-1).

I-8. **Deliberate Planning.** Prepares for a possible contingency based on the best available information, using forces and resources apportioned for deliberate planning by the Joint Strategic Capabilities Plan (JSCP). This plan relies heavily on assumptions regarding the political and military circumstances that may exist when the plan is implemented. Deliberate planning is conducted principally in peacetime to develop joint operation plans for contingencies identified in strategic planning documents.

I-9. **Crisis Action Planning.** Based on current events and conducted in time-sensitive situations and emergencies using assigned, attached, and allocated forces and resources. Crisis action planners base their plan on the actual circumstances that exist at the time planning occurs. They follow prescribed CAP procedures that parallel deliberate planning, yet are more flexible and

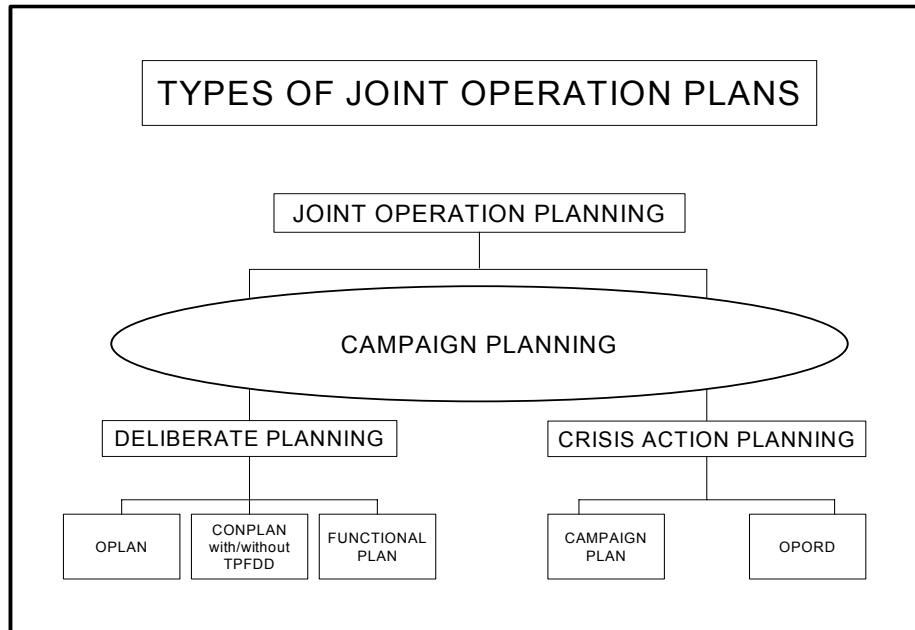

responsive to changing events.

**Figure I-1. Types of Joint Operation Plans**

I-10. **Campaign Planning.** Combatant commanders translate national and theater strategy into strategic and operational concepts through the development of theater campaign plans. The campaign plan embodies the combatant commander’s strategic vision for the arrangement of related operations necessary to attain theater strategic objectives. Campaign planning encompasses both the deliberate and CAP processes. If the scope of contemplated operations requires it, campaign planning begins with or during deliberate planning. It continues through CAP, unifying both planning processes.

**TYPES OF JOINT PLANS**

I-11. Deliberate plans are prepared under joint procedures and in prescribed formats such as an OPLAN, CONPLAN (with or without time-phased force and deployment data (TPFDD)), or a functional plan. If combatant commanders request supporting plans to their deliberate plans, they are prepared by supporting combatant commanders, subordinate joint force commanders, component commanders, or other agencies.

I-12. **OPLAN.** A complete and detailed operation plan describing the concept of operations including all required annexes with associated appendixes (see Figure I-2 and I-3). It identifies the specific forces, functional support, deployment sequence, and resources required to execute the plan. It provides closure

estimates for the movement of forces into the theater. An OPLAN can be used as the basis of a campaign plan (if required) and then developed into an operation order (OPORD).

I-13. **CONPLAN Without TPFDD.** An operation plan in an abbreviated format that requires expansion or alteration to convert it into an OPLAN, campaign plan, or OPORD. A CONPLAN contains a combatant commander's strategic concept and those annexes and appendices either required by the joint strategic capabilities plan (JSCP) or deemed necessary by the combatant commander to complete planning.

I-14. **CONPLAN With TPFDD.** Similar to a CONPLAN with more detailed planning for phased deployment of forces. Detailed planning may be required to support a contingency of compelling interest that may be critical to national security, but not likely to occur in the near term.

I-15. **Functional Plans.** Traditionally developed for specific functions or discreet tasks (for example, nuclear weapon recovery or evacuation, logistics, communications, or continuity of operations) during military operations in a peacetime or permissive environment. A functional plan may also be developed to address functional peacetime operations such as disaster relief, humanitarian assistance, or counterdrug operations.

I-16. **OPORD.** Prepared under joint procedures in prescribed formats during CAP, OPORDs are in the form of a directive issued by a command to subordinate commanders to coordinate the execution of an operation.

## JOINT OPERATION PLAN FORMAT

I-17. The joint OPLAN/OPORD format is not the same as the Army tactical OPLAN/OPORD format located in Appendix G. The joint OPLAN format is designed to address those functions and activities at the operational-level of war. The joint format provides instruction to synchronize all available land, sea, air, space-based assets, and special operations forces, to accomplish operational and strategic objectives. The Army OPLAN/OPORD format is focused at the tactical-level of war to provide instructions and directives to tactical units and synchronize the battlefield operations system to accomplish missions.

I-18. Figure I-2 provides the format with annotated instruction of the base portion of a Joint OPLAN. Figure I-3 lists annexes, appendices, and tabs for joint OPLANs/OPORDs.

**CLASSIFICATION**

**HEADQUARTERS, US EUROPEAN COMMAND  
APO AE 09128  
28 February 1999**

**USCINCEUR OPLAN 4999-99 ( )  
DEFENSE OF WESTERN EUROPE IN GENERAL WAR ( )**

**( ) References:**

**1. SITUATION**

**a. ( ) General.** Describe the general politico-military environment that would establish the probable preconditions for execution of the plan. When submitting a CINC's Strategic Concept include, as an opening statement in this subparagraph, a reference to the tasking from the JSCP or other tasking document. Summarize the competing political goals that could cause the conflict. Identify primary antagonists. State US policy goals and the estimated goals of other parties. Outline political decisions needed from other countries to achieve US policy goals and conduct effective US military operations to attain US military missions.

**b. ( ) Area of Concern**

**(1) ( ) Area of Responsibility.** Describe the commander's area of responsibility. A map may also be included as an attachment.

**(2) ( ) Area of Interest.** Describe the general area of interest covered by the CINC's Strategic Concept and/or Basic Plan. This description should address all air, ground, and sea areas that directly affect the operation. A map may also be included as an attachment.

**(3) ( ) Operational Area.** Describe the specific areas covered in each option contained in the CINC's Strategic Concept or Basic Plan. Maps may also be included as attachments.

**c. ( ) Deterrent Options.** Delineate deterrent options desired to include those categories specified in the current JSCP. Specific units (type of units for CINC's Strategic Concept format) and resources must be prioritized in terms of LAD relative to C-day. Include possible diplomatic, informational, or economic deterrent options accomplished by non-DOD agencies that would support US mission accomplishment.

**d. ( ) Enemy Forces.** Identify the opposing forces expected on execution and appraise their general capabilities. When preparing the Basic Plan, refer the reader to Annex B for details; however, provide the information essential to a clear understanding of the magnitude of the hostile threat. When preparing a CINC's Strategic Concept, provide all information essential to a clear understanding of the magnitude of the hostile threat. When applicable, identify the enemy's strategic and operational centers of gravity for both the CINC's Strategic Concept and the Basic Plan.

**CLASSIFICATION**

**Figure I-2. Joint OPLAN Format**

**CLASSIFICATION**

**e. ( ) Friendly Forces**

(1) ( ) Identify friendly centers of gravity, both strategic and operational, that require protection for the successful accomplishment of the mission.

(2) ( ) Describe the operations of unassigned forces, other than those tasked to support this operation, that could have a direct significant influence on the operations envisaged in this plan.

(3) ( ) List the specific tasks of friendly forces, commands, or government agencies that would directly support OPOD execution (e.g., USTRANSCOM, USSTRATCOM, Defense Intelligence Agency (DIA)).

**f. ( ) Assumptions.** List all assumptions, including common assumptions contained in the JSCP or other tasking, on which the plan is based. State expected conditions over which the commander has no control. Include assumptions that are directly relevant to the development of this plan and supporting plans and assumptions that express conditions that, should they not occur as expected, would invalidate the entire plan or its concept of operations. Include additional assumptions relevant to specific aspects of the operation in appropriate annexes. Specify the mobility (air and sea lift), the degree of mobilization assumed (i.e., total, full, partial, selective, or none), and the applicability of the Presidential Selected Reserve Call-up Authority.

**g. ( ) Legal Considerations.** List those significant legal considerations on which the plan is based.

**2. ( ) MISSION.** State concisely the task and purpose to be accomplished on execution. This statement should answer the following questions: who, what, when, where, why, and (occasionally) how. State the mission of the commander originating the plan (for example, the mission may be the task assigned by the Chairman or it may be deduced from the Commander's Estimate based on a task assigned by the Chairman). If the plan being prepared is a supporting plan, indicate the plan that it supports and include, when applicable, plans prepared by commanders of allied forces.

**3. ( ) EXECUTION**

**a. ( ) Concept of Operations.** For most OPLANs, CONPLANs, FUNCPLANs, and the CINC's Strategic Concept, include the entire concept of operations in this section. However, some OPLANs necessarily encompass alternative COAs for accomplishing the mission, and others require considerable detail to convey adequate guidance for the development of supporting plans. Accordingly, the entire concept may be placed in Annex C.

(1) ( ) **Commander's Intent.** Describe the commander's overall intent, and intent by phase. Describe the desired end state.

**CLASSIFICATION**

Figure I-2. Joint OPLAN Format (continued)



**CLASSIFICATION**

It should be a concise expression of the purpose of each phase of the operation. It may include how the posture of units at that end state facilitates transition to future operations. It may also include the commander's assessment of the enemy commander's intent. The commander's intent is not, however, a summary of the concept of operations.

**(2.) ( )General.** Base the concept of operations on the commander's estimate of the situation. The estimate states how the commander plans to accomplish the mission, including the forces involved; the time phasing of operations; the general nature and purpose of operations to be conducted; and the interrelated or cross-Service support, coordination, and cooperation necessary for successful execution. The commander's estimate should include a statement concerning the perceived need for Reserve force mobilization based on plan force deployment timing and Reserve force size requirements. The concept of operations should be sufficiently developed to include an estimate of the level and duration of conflict to provide supporting and subordinate commanders a basis for preparing adequate supporting plans. To the extent possible, the plan should incorporate the following concepts of joint operation planning doctrine:

Combatant commander's strategic intent and operational focus.

Orientation on the strategic and operational centers of gravity of the threat.

Protection of friendly strategic and operational centers of gravity.

Phasing of operations, to include the commander's intent for each phase.

A graphic timeline may be used to assist in describing the various options or phases covered in the concept to include items such as warning and response times, major deployments, and employment phases. The concept should show how the initiative will be gained, security against enemy actions will be maintained, and superiority and surprise will be achieved. In the Basic Plan, reference should be made to Annex A for detailed force requirements. Additionally, if commanders anticipate sustained armed conflict during execution of the plan, the concept of operations should outline the synchronized employment of air, land, maritime, space, and special operations (SO) forces in a joint campaign. Incorporate Special Technical Operations into the overall concept in a separately published plan annex. Acknowledging that details of campaigns cannot be determined before armed conflict, sufficient detail should be provided to guide force structure, organization, and development, and the planning and conduct of preconflict operations.

**CLASSIFICATION**

Figure I-2. Joint OPLAN Format (continued)

**CLASSIFICATION**

Note on OPLAN Structure: For plans addressing situations that could involve armed conflict, the next two paragraphs must include a separate description for each phase of the operation. These phases should include, as applicable, the following:

- (a) ( ) Prehostilities.
- (b) ( ) Lodgment.
- (c) ( ) Decisive Combat and Stabilization.
- (d) ( ) Follow Through.
- (e) ( ) Posthostilities and Redeployment.

**(3) ( ) Deployment.** Deployment is an operational imperative. Summarize the concept for strategic and theater to place forces, equipment, and supplies in the operational area. Concept must cover the movement from point of origin to final destination. Address deployment priorities, proposed requirement and routing for strategic air mobility assets/air bridges (in coordination with USTRANSCOM) and sea lanes, and the need for frequency and/or requirements channels. Priority for deployment must specify forces or capabilities having priority for deployment ahead of other movement requirements. Priority for deployment may be identified in terms of specific force required delivery dates or specific dates when a functional capability is required in theater. When supporting multiphased operations, priorities must be identified for each phase of the operation. Additionally, the requirement for operating frequency and/or requirement channels to support operations and the sustainment of forces and equipment must be considered and included in the plan. Include special guidance for transportation operations that would not normally be encountered, such as the need for joint logistics over-the-shore operations, assault by airdrop of troops and equipment, or the need for building or improving assault landing fields or support facilities. Also include the use of maritime pre-positioning ships and afloat pre-positioning ships following discharge of cargo and prior to revision of the common-user pool as theater shipping resources. Address how distribution in the operational area will be accomplished and how distribution items from outside the operational area will be integrated in the theater distribution system. When applicable, include deployments and OPSEC measures expected to be carried out before implementation of the plan.

**(4) ( ) Employment.** Describe the concept of how the forces are employed in each of the phases contained in OPLAN structure listed above. The concept should clearly outline plans for the use of nuclear weapons and riot control agents, if any. Plans to conduct supporting operations (e.g., IO, SO, search and rescue (SAR), reconnaissance, and space) must be indicated in this section for the Combatant Commander's Strategic Concept or by reference to appropriate appendixes of Annex C for the Basic Plan.

**CLASSIFICATION**

Figure I-2. Joint OPLAN Format (continued)

**CLASSIFICATION**

Summarize any specific Reserve Component augmentation requirements for plan execution. When a nuclear appendix or deception tab is not prepared for Annex C, a statement to that effect must be made in this paragraph. A graphic timeline may be used to assist in describing the various options and phases covered.

**b. ( ) Tasks**

(1) ( ) List the tasks assigned to each element of the supported and supporting commands in separate numbered sub-subparagraphs. Each task should be a concise statement of a mission to be performed either in future planning for the operation or on execution of the OPORD. The task assignment should encompass all key actions that subordinate and supporting elements must perform to fulfill the concept of operations, including operational and tactical military deceptions. However, do not link the actions to deception. If the actions cannot stand alone without exposing the deception, they must be published only in Tab A to Appendix 3 to Annex C to receive special handling.

(2) ( ) When the plan requires the establishment of a subordinate joint force, tasks are assigned by the Combatant Commander to the component commanders, supporting commanders, and subordinate joint force commanders, as appropriate. State the support that each component is expected to provide for another.

**c. ( ) Coordinating Instructions.** List the instructions applicable to the entire command or two or more elements of the command that are necessary for proper coordination of the operation but are not appropriate for inclusion in a particular annex. Coordinating instructions establish, in particular, the conditions for execution. Explain terms pertaining to the timing of execution and deployments. Also explain other operational terms that appear in the plan but are not defined in Joint Staff publications.

**4. ( ) ADMINISTRATION AND LOGISTICS**

**a. ( ) Concept of Support.** In preparing the Basic Plan, the major portion of guidance on Service support is normally contained in a series of detailed annexes listed in the subsequent subparagraphs. To provide a general understanding of the requirements for logistic support, personnel policies, and administrative plans, this subparagraph should provide broad guidance on how such support is to be furnished. Additional subparagraphs refer to the annexes that provide detailed guidance on each major aspect of support. When preparing the Combatant Commander's Strategic Concept, this subparagraph must state the same broad guidance on how such support is to be furnished. Instead of referring to specific annexes in the subsequent subparagraphs, this subparagraph must provide additional summary level guidance.

**CLASSIFICATION**

Figure I-2. Joint OPLAN Format (continued)

**CLASSIFICATION**

**b. ( ) Logistics.** In preparing a Basic Plan, refer to Annex D. When preparing the Combatant Commander's Strategic Concept, state the policies, guidance, and procedures to support all options for operations contained in the Combatant Commander's Strategic Concept. Logistic phases must be concurrent with operational phases. This subparagraph should address sustainment priorities and resources; base development and other civil engineering requirements; host-nation support; and inter-Service responsibilities. Identify the priority and movement of major logistic items for each option and phase of the concept. Identify strategic and theater ports for resupply. Outline transportation policies, guidance, and procedures for all options. Identify logistic and transportation assumptions and include them with other plan assumptions in subparagraph 1f. Identify detailed planning requirements and subordinate taskings.

**c. ( ) Personnel.** In preparing a Basic Plan, refer to Annex E. When preparing the Combatant Commander's Strategic Concept, state the policies, guidance, concept, and procedures to support all options contained in the Combatant Commander's Strategic Concept. Identify detailed planning requirements and subordinate taskings. Assign tasks for establishing and operating joint personnel facilities, managing accurate and timely personnel accountability and strength reporting, and making provisions for staffing them. Discuss the administrative management of participating personnel, the reconstitution of forces, command replacement and rotation policies, and required individual augmentation to command headquarters and other operational requirements.

**d. ( ) Public Affairs.** In preparing the Basic Plan, refer to Annex F.

**e. ( ) Civil Affairs.** In preparing the Basic Plan, refer to Annex G.

**f. ( ) Meteorological and Oceanographic Services.** In preparing the Basic Plan, refer to Annex H.

**g. ( ) Geospatial Information and Services.** In preparing the Basic Plan refer to Annex M.

**h. ( ) Medical Services.** In preparing the Basic Plan, refer to Annex Q. When preparing the Combatant Commander's Strategic Concept outline the policies and guidance for medical care and support. Identify planning requirements and subordinate taskings for hospitalization and evacuation. Address critical medical supplies and resources. Assign tasks for establishing joint medical authorities and provisions for staffing them. Identify medical assumptions and include them in subparagraph 1f, Assumptions. Refer to wartime host-nation support agreements or provisions to support in Annex P.

**CLASSIFICATION**

**Figure I-2. Joint OPLAN Format (continued)**

**CLASSIFICATION**

**5. ( ) COMMAND AND CONTROL**

**a. ( ) Command**

**(1) ( ) Command Relationships.** When preparing a Basic Plan, refer to Annex J. When preparing the Combatant Commander's Strategic Concept, state the organizational structure expected to exist during plan implementation. Indicate any changes to major command and control organizations and the time of the expected shift. Identify all command arrangement agreements (CAAs) and memorandums of understanding (MOUs) used and those that require development.

**(2) ( ) Command Posts.** List the designations and locations of each major headquarters involved in execution. When headquarters are to be deployed or the OPLAN provides for the relocation of headquarters to an alternate command post, indicate the location and time of opening and closing of each headquarters.

**(3) ( ) Succession to Command.** Designate in order of succession the commanders responsible for assuming command of the operation in specific applicable circumstances.

**b. ( ) Command, Control, Communications, and Computer (C4) Systems.** Provide a general statement concerning the scope of C4 systems and procedures required to support the operation. Highlight any C4 systems or procedures requiring special emphasis. When preparing a Basic Plan, refer to Annex K for details.

s/

t/

General, (Service Branch)

Commander in Chief

Annexes

(Listing of Annexes is not required when preparing Combatant Commanders Strategic Concept.)

**CLASSIFICATION**

Figure I-2. Joint OPLAN Format (continued)

Figure I-3. Sequence of Annexes and Appendixes to an OPLAN/OPORD

<p><b>ANNEX A - TASK ORGANIZATION</b>  Appendix 1 - Time-Phased Force and Deployment List  Appendix 2 – Shortfall Identification  Appendix 3 - Force Module Identification  Appendix 4 - Deterrent Options  Tab A - Deterrent Options Layout</p> <p><b>ANNEX B - INTELLIGENCE</b>  Appendix 1 - Priority Information Requirements  Appendix 2 - Signals Intelligence  Tab A - Communications Intelligence Collection Requirements  Tab B - Operational Electronic Intelligence Collection  Appendix 3 - Counterintelligence  Tab A - Counterintelligence Target List  Tab B - Multidiscipline Counterintelligence Threat Report  Tab C - Designation of Theater CI Executive Agency  Tab D - Umbrella CI Force Protection Source Operation Proposal  Appendix 4 - Targeting  Tab A - Target List (Conventional)  Tab B - Target List (N0-Strike)  Tab C - Target List (Restricted)  Appendix 5 e Intelligence  Tab A - HUMINT Operations Cell (HOC)  Tab B - EPW/Civilian Detainees  Appendix 6 - Intelligence Support to IO  Appendix 7 - Imagery Intelligence  Appendix 8 - Measurement and Signature Intelligence  Appendix 9 - Captured Enemy Equipment  Tab A - Specific Prioritized Intelligence Collection Requirements  Tab B- Equipment Released for Operational Purposes  Appendix 10 - National Intelligence Support Team</p> <p><b>ANNEX C - OPERATIONS</b>  Appendix - Nuclear Operations  Tab A - Target List</p>	<p>Appendix 2 - Nuclear, Biological, and Chemical Defense Operations; Riot Control Agents and Herbicides  Appendix 3 - Information Operations  Tab A - Military Deception  Tab B - Electronic Warfare  Tab C - Operations Security  Tab D - Psychological Operations  Tab E - Physical Attack/Destruction  Tab F - Computer Network Attack  Tab G - Defensive Information Operations  Appendix 4 – Special Operations  Appendix 5 - Personnel Recovery (PR) Operations  Appendix 6 - Rules of Engagement (ROE)  Appendix 7 – Reconnaissance  Appendix 8 - Air Base Operability  Appendix 9 - Combat Camera  Tab A - COMCAM Customer Support Requirements  Appendix 10 - Non-Combatant Evacuation  Appendix 11 - Escape and Evasion Operations  Appendix 12 - Counterattack  Appendix 13 - Explosive Ordnance Disposal  Tab A - Forces List  Appendix 14 - Amphibious Operations  Appendix 15 - Force Protection  Tab A - Combating Terrorism  Tab B - Physical Security  Tab C - Base Defense  Appendix 16 - Critical Infrastructure Protection</p> <p><b>ANNEX D - LOGISTICS</b>  Appendix 1 - Petroleum, Oils, and Lubricants Supply  Tab A - Estimate of POL Support Requirements  Appendix 2 - Water Supply  Appendix 3 - Mortuary Affairs  Appendix 4 - Sustainability Analysis</p>
---	--

<p><b>Appendix 5 - Mobility and Transportation</b>  <b>Tab A - En Route Support Requirements</b>  <b>Tab B - Reception, Staging, Onward Movement, and Integration (RSOI)</b>  <b>Appendix 2 - Equipment and Support Requirements for JIBs / SUB-JIBs</b>  <b>Tab C - Primary and Alternate Ports</b>  <b>Appendix 6 - Civil Engineering Support Plan</b>  <b>Tab A - Suggested Construction Standards for Military Construction and Civil Engineering Support of Joint Operations</b>  <b>Appendix 7 - Non-nuclear Ammunition</b>  <b>Tab A - Munitions Matrix</b>  <b>Appendix 8 - Logistics Automation</b>  <b>ANNEX E - PERSONNEL</b>  <b>Appendix 1 - Enemy Prisoners of War, Civilian Internees, and other Detained Persons</b>  <b>Appendix 2 - Processing of Formerly Captured, Missing, or Detained US Personnel</b>  <b>Appendix 3 - Finance and Disbursing</b>  <b>Appendix 4 – Legal</b>  <b>Appendix 5 - Military Postal Services</b>  <b>Tab A - Aerial Mail Terminals</b>  <b>Tab B - Military Post Offices</b>  <b>Appendix 6 - Chaplain Activities</b>  <b>Tab A - Inter-Service Chaplain Support</b>  <b>Tab B - Host-Nation Religious Support</b>  <b>Tab C - Commander-Staff Chaplain Relationships</b>  <b>ANNEX F - PUBLIC AFFAIRS</b>  <b>Appendix 1 - Personnel Requirements for JIBs and SUB-JIBs</b>  <b>Appendix 2 – Equipment and Support Requirements for JIBs and SUB-JIBs</b>  <b>Appendix 3 - General Ground Rules for the Media</b>  <b>Appendix 4 - DoD National Media Pool</b>  <b>ANNEX G - CIVIL AFFAIRS</b></p>	<p><b>ANNEX J – COMMAND RELATIONSHIPS</b>  <b>Appendix 1 - Command Relationships Diagram</b>  <b>ANNEX K - COMMAND, CONTROL, COMMUNICATION, AND COMPUTER SYSTEMS</b>  <b>Appendix 1 - Information Assurance (IA)</b>  <b>Tab A - Information Security (INFOSEC)</b>  <b>Appendix 2 - Command, Control, Communications and Computer Planning</b>  <b>Appendix 3 - Satellite Communications Planning</b>  <b>Tab A - UHF SATCOM Network List</b>  <b>Tab B -SHF SATCOM Network List</b>  <b>Tab C - EHF SATCOM Network List</b>  <b>Tab D - Commercial SATCOM Network List</b>  <b>Appendix 4 - Defense Courier Service</b>  <b>Appendix 5 - Foreign Data Exchanges</b>  <b>Appendix 6 – Frequency Spectrum Planning</b>  <b>Tab A - Electromagnetic Interference (EMI) Reporting</b>  <b>Tab B - JTF JCEOI Concept</b>  <b>Tab C - Spectrum Use Plan</b>  <b>Appendix 7 - JTF C4 Deployment Checklist</b>  <b>ANNEX L – ENVIRONMENTAL CONSIDERATIONS</b>  <b>Appendix 1 - Environmental Assessments</b>  <b>Appendix 2 - Environmental Assessment Exemptions</b>  <b>Appendix 3 - Joint Environmental Management Board</b>  <b>ANNEX M – GEOSPATIAL INFORMATION AND SERVICES (GI&amp;S)</b>  <b>Appendix 1 - GEOSPATIAL Information and Services Requirements List</b>  <b>Appendix 2 - GEOSPATIAL Information and Services Transportation Requirements</b>  <b>Appendix 3 - GEOSPATIAL Information</b></p>
--	--

<b>ANNEX H – METEOROLOGICAL AND OCEANOGRAPHIC OPERATIONS</b>	<b>and Services Reports (Optional)</b>
<b>ANNEX P - HOST-NATION SUPPORT</b>	<b>ANNEX N - SPACE OPERATIONS</b>
<b>Appendix 1 - List of HNS Agreements</b>	<b>ANNEX U - NOTIONAL CP DECISION GUIDE</b>
<b>Appendix 2 - HNS Reliability</b>	<b>ANNEX V – INTERAGENCY COORDINATION</b>
<b>Appendix 3 - Presumed HNS</b>	<b>Appendix 1 - Humanitarian</b>
<b>ANNEX Q - MEDICAL SERVICES</b>	<b>Appendix 2 – Economic</b>
<b>ANNEX R - REPORTS</b>	<b>Appendix 3 – Political</b>
<b>ANNEX S – SPECIAL TECHNICAL OPERATIONS</b>	<b>ANNEX X – EXECUTION CHECKLIST</b>
<b>ANNEX T – CONSEQUENCE MANAGEMENT (CM)</b>	<b>ANNEX Z – DISTRIBUTION</b>

**NOTE:** Uses of bold font and different font sizes in headings are solely for emphasis within this manual. Boldface paragraph numbers, letters, and titles denote normal paragraph headings. Bullet lists also suggest items that may go in subparagraphs.



## Glossary

<b>A2C2</b>	Army airspace command and control
<b>AA</b>	assembly area
<b>AAA</b>	antiaircraft artillery (graphic only)
<b>ABCS</b>	Army Battle Command System
<b>accidental risk</b>	All operational risk considerations other than tactical risk. Includes risk to friendly force and risk posed to civilians by an operation, as well as the impact of operations on the environment (FM 100-14).
<b>ACOS</b>	assistant chief of staff
<b>AD</b>	armored division
<b>ADA</b>	air defense artillery
<b>ADCON</b>	administrative control
<b>administrative control</b>	Direction or exercise of authority over subordinate or other organizations in respect to administration and support, including organization of Service forces, control of resources and equipment, personnel management, unit logistics, individual and unit training, readiness, mobilization, demobilization, discipline, and other matters not included in the operational missions of the subordinate or other organizations (JP 1-02).
<b>AG</b>	adjutant general
<b>AGM</b>	attack guidance matrix
<b>AI</b>	air interdiction
<b>AOI</b>	area of interest
<b>air interdiction</b>	Air operations conducted to destroy, neutralize, or delay the enemy's military potential before it can be brought to bear effectively against friendly forces at such distance from friendly forces that detailed integration of each air mission with the fire and movement of friendly forces is not required (JP 1-02).
<b>alternate supply route</b>	A route or routes designated within an area of operations to provide for the movement of traffic when main supply routes become disabled or congested (FM 4-0).
<b>AO</b>	area of operations
<b>APO</b>	Army Post Office (graphic only)
<b>AR</b>	Army Regulation; armor

<b>area of interest</b>	That area of concern to the commander, including the area of influence, areas adjacent thereto, and extending into enemy territory to the objectives of current or planned operations. This area also includes areas occupied by enemy forces who could jeopardize the accomplishment of the mission (JP 1-02).
<b>area of operations</b>	An operational area defined by the joint force commander for land and naval forces. Areas of operation do not typically encompass the entire operational area of the joint force commander, but should be large enough for component commanders to accomplish their missions and protect their forces (JP 1-02).
<b>ARFOR</b>	The senior Army headquarters and all Army forces assigned or attached to a combatant command, subordinate joint force command, joint functional command, or multinational command (FM 3-0).
<b>armd</b>	armored (graphic only)
<b>Army airspace command and control</b>	The Army's application of airspace control to coordinate airspace users for concurrent employment in the accomplishment of assigned missions (FM 3-52).
<b>arty</b>	artillery (graphic only)
<b>ASCC</b>	Army service component commands
<b>ASCOPE</b>	A memory aid for the characteristics considered under civil considerations: areas, structures, capabilities, organizations, people, events (FM 6-0).
<b>ASR</b>	alternate supply route
<b>assign</b>	To place units or personnel in an organization where such placement is relatively permanent, and/or where such organization controls and administers the units or personnel for the primary function, or greater portion of the functions, of the unit or personnel (JP 1-02).
<b>attach</b>	The placement of units or personnel in an organization where such placement is relatively temporary (JP 1-02).
<b>*attachment</b>	A collective term for annex, appendix, tab, and enclosure.
<b>AUTL</b>	Army universal task list
<b>avenue of approach</b>	The air or ground route of an attacking force of a given size leading to its objective or key terrain in its path (JP 1-02).
<b>AW</b>	automatic weapons (graphic only)
<b>battle drill</b>	Standardized actions made in response to common battlefield occurrences. They are designed for rapid reaction situations (FM 7-10).

<b>battlefield organization</b>	The allocation of forces in the area of operations by purpose. It consists of three all-encompassing categories of operations: decisive, shaping, and sustaining (FM 3-0).
<b>battlespace</b>	The environment, factors, and conditions that must be understood to successfully apply combat power, protect the force, or complete the mission. This includes the air, land, sea, space, and the included enemy and friendly forces; facilities; weather; terrain; the electromagnetic spectrum; and the information environment within the operational areas and areas of interest (JP 1-02).
<b>BDA</b>	battle damage assessment
<b>bde</b>	brigade (graphic only)
<b>bn</b>	battalion
<b>BOS</b>	battlefield operating systems
<b>branch</b>	A contingency plan or course of action (an option built into the basic plan or course of action) for changing the mission, disposition, orientation, or direction of movement of the force to aid success of the current operation, based on anticipated events, opportunities, or disruptions caused by enemy actions. Army forces prepare branches to exploit success and opportunities, or to counter disruptions caused by enemy actions (FM 3-0).
<b>C2</b>	command and control
<b>C4</b>	command, control, communications, and computers
<b>CAS</b>	close air support
<b>cav</b>	cavalry (graphic only)
<b>CCIR</b>	commander's critical information requirements
<b>cdr</b>	commander (graphic only)
<b>CHS</b>	combat health support
<b>CI</b>	counterintelligence
<b>civil affairs</b>	Designated Active and Reserve component forces and units organized, trained, and equipped specifically to conduct civil affairs activities and to support civil-military operations (JP 1-02).
<b>civil considerations</b>	The influence of manmade infrastructure, civilian institutions, and attitudes and activities of the civilian leaders, populations, and organizations within an area of operations on the conduct of military operations (FM 6-0).
<b>civil-military operations</b>	The activities of a commander that establish, maintain, influence, or exploit relations between military forces, governmental and nongovernmental civilian organizations and authorities, and the civilian populace in a friendly, neutral, or hostile operational area in order to facilitate military operations, to consolidate and achieve operational US objectives. Civil-military operations may

include performance by military forces of activities and functions normally the responsibility of the local, regional, or national government. These activities may occur prior to, during, or subsequent to other military actions. They may also occur, if directed, in the absence of other military operations. Civil-military operations may be performed by designated civil affairs, by other military force, or by a combination of civil affairs and other forces (JP 1-02).

<b>CJCSM</b>	chairman, Joint Chiefs of Staff manual
<b>close air support</b>	Air action by fixed- and rotary-wing aircraft against hostile targets that are in close proximity to friendly forces and that require detailed integration of each air mission with the fire and movement of those forces. (JP 1-02).
<b>cm</b>	chemical (graphic only)
<b>CMO</b>	civil-military operations
<b>co.</b>	company (graphic only)
<b>COA</b>	course of action
<b>COL</b>	colonel
<b>*collaborative planning</b>	The real-time interaction among commanders and staffs at two or more echelons developing plans for a single operation.
<b>COLT</b>	combat observation and lasing team
<b>lasing team</b>	A fire support team controlled at the brigade level that is capable of target acquisition under reduced visibility conditions and has both laser-rangefinding and laser-designating capabilities (FM 6-20-40).
<b>combat power</b>	The total means of destructive and/or disruptive force that a military unit/formation can apply against the opponent at a given time (JP 1-02).
<b>combat service support</b>	The essential capabilities, functions, activities, and tasks necessary to sustain all elements of operating forces in theater at all levels of war. Within the national and theater logistic systems, it includes but is not limited to that support rendered by service forces in ensuring the aspects of supply, maintenance, transportation, health services, and other services required by aviation and ground combat troops to permit those units to accomplish their missions in combat. Combat service support encompasses those activities at all levels of war that produce sustainment to all operating forces on the battlefield.
<b>combat support</b>	Critical combat functions provided by units and soldiers in conjunction with combat arms units and soldiers to secure victory (FM 3-90).
<b>command and control</b>	The exercise of authority and direction by a properly designated commander over assigned and attached forces in the

accomplishment of the mission. Commanders perform command and control functions through a command and control system (FM 6-0).

<b>commander's critical information requirements</b>	1) A comprehensive list of information requirements identified by the commander as being critical in facilitating timely information management and the decision making process that affect successful mission accomplishment. The two key subcomponents are critical friendly force information and priority intelligence requirements (JP 1-02). 2) Elements of information required by commanders that directly affect decision making and dictate the successful execution of military operations (FM 3-0).
<b>commander's intent</b>	A clear, concise statement of what the force must do and the conditions the force must meet to succeed with respect to the enemy, terrain, and the desired end state (FM 3-0).
<b>commander's visualization</b>	The mental process of achieving a clear understanding of the force's current state with relation to the enemy and environment (situational understanding), and developing a desired end state that represents mission accomplishment, and the key tasks that move the force from its current state to the end state (commander's intent) (FM 6-0).
<b>common operational picture</b>	An operational picture tailored to the user's requirements, based on common data and information shared by more than one command (FM 3-0).
<b>concealment</b>	The protection from observation and surveillance (JP 1-02).
<b>concept of operations</b>	Describes how commanders see the actions of subordinate units fitting together to accomplish the mission. As a minimum, the description includes the scheme of maneuver and concept of fires. The concept of operations expands the commander's selected course of action and expresses how each element of the force will cooperate to accomplish the mission (FM 3-0).
<b>*constraint</b>	A restriction placed on the command by a higher command. A constraint dictates an action or inaction, thus restricting the freedom of action a subordinate commander has for planning.
<b>contingency plan</b>	A plan that provides for major contingencies that can reasonably be anticipated in the principal geographic sub-areas of the command (JP 1-02). Contingency plans may take the form of branches or sequels.
<b>controlled supply rate</b>	The rate of ammunition consumption that can be supported, considering availability, facilities, and transportation. It is expressed in rounds per unit, individual, or vehicle per day. The Army service component commander announces the controlled supply rate (CSR) for each item of ammunition, and, in turn, the commander of each subordinate tactical unit announces a CSR to his commanders at the next lower levels. A unit may not draw

	ammunition in excess of its CSR without authority from its next higher headquarters (FM 9-6).
<b>*control measures</b>	Directives given graphically or orally by a commander to subordinate commands to assign responsibilities, coordinate fires and maneuver, and control operations. Control measure can be portrayed graphically. In general, all control measures should be easily identifiable on the ground.
<b>COP</b>	common operational picture
<b>COS</b>	Chief of Staff
<b>counterintelligence</b>	Information gathered and activities conducted to protect against espionage, other intelligence activities, sabotage, or assassinations conducted by or on behalf of foreign governments or elements thereof, foreign organizations, or foreign persons, or international terrorist activities (JP 1-02).
<b>course of action</b>	1) Any sequence of activities that an individual or unit may follow. 2) A possible plan open to an individual or commander that would accomplish, or is related to the accomplishment of the mission. 3) The scheme adopted to accomplish a job or mission. 4) A line of conduct in an engagement. 5) A product of the Joint Operation Planning and Execution System concept development phase (JP 1-02).
<b>cover</b>	Protection from the effects of fires (FM 6-0).
<b>CP</b>	command post
<b>CS</b>	combat support
<b>CSR</b>	controlled supply rate
<b>CSS</b>	combat service support
<b>date-time group</b>	The date and time, expressed in digits and time zone suffix, at which the message was prepared for transmission. (Expressed as six digits followed by the time zone suffix; first pair of digits denotes the date, second pair the hours, third pair the minutes, followed by a three-letter month abbreviation and two-digit year abbreviation) (JP 1-02).
<b>decision making</b>	Selecting a course of action as the one most favorable to accomplish the mission (FM 6-0).
<b>*decision point</b>	An event, area, or point in the battlespace where and when the friendly commander will make a critical decision.
<b>*decision support matrix</b>	An aid used by the commander and staff to make battlefield decisions. This matrix is a staff product of the war-gaming process that lists the decision point, location of the decision point, the criteria to be evaluated at the point of decision, the action or operations to occur at the decision point, and the unit or element that is to act and has responsibility to observe and report the information affecting the criteria for the decision.

<b>decision support template</b>	A staff product initially used in the war-gaming process that graphically represents the decision points and projected situations, and indicates when, where, and under what conditions a decision is most likely to be required to initiate a specific activity or event.
<b>decisive operation</b>	Operations that directly accomplish the task assigned by the higher headquarters. Decisive operations conclusively determine the outcome of major operations, battles, and engagements (FM 3-0).
<b>decisive point</b>	A geographic place, specific key event, critical system, or function that allows commanders to gain a marked advantage over an enemy and greatly influence the outcome of an attack. See also centers of gravity (JP 1-02).
<b>DEH</b>	director of engineering and housing
<b>deliberate operation</b>	An operation in which a commander's detailed intelligence concerning the situation allows him to develop and coordinate detailed plans, including multiple branches and sequels. He task organizes his forces specifically for the operation to provide a fully synchronized combined arms team. He conducts extensive rehearsals while conducting shaping operations to set the conditions for the conduct of his decisive operation (FM 3-90).
<b>*direct support</b>	A mission (support relationship) requiring a force to support another specific force and authorizing it to answer directly to the supported force's request for assistance.
<b>div</b>	division
<b>DIVARTY</b>	division artillery
<b>DP</b>	decision point
<b>DS</b>	direct support
<b>DSA</b>	division support area
<b>DST</b>	decision support template
<b>DTG</b>	date-time group
<b>EAC</b>	echelons above corps
<b>echelons above corps</b>	Army headquarters and organizations that provide the interface between the theater commander (joint or multinational) and the corps for operational matters (FM 100-7).
<b>EEFI</b>	essential elements of friendly information
<b>electronic warfare</b>	Any military action involving the use of electromagnetic and directed energy to control the electromagnetic spectrum or to attack the enemy (major subdivisions within electronic warfare are electronic attack, electronic protection, and electronic warfare support [JP 1-02]) (JP 3-51).
<b>encl</b>	enclosure

<b>end state</b>	At the operational and tactical levels, the conditions that, when achieved, accomplish the mission. At the operational level, these conditions attain the aims set for the campaign or major operation (FM 3-0).
<b>enemy prisoner of war</b>	An individual or group of individuals detained by friendly forces in any operational environment who meet the criteria as listed in Article 4 of the Geneva Convention relative to the Treatment of Prisoners of War (FM 34-52).
<b>enr</b>	engineer (graphic only)
<b>EPW</b>	enemy prisoner of war
<b>essential elements of friendly information</b>	Critical aspects of a friendly operation that, if known by the enemy, would subsequently compromise, lead to failure, or limit success of the operation, and therefore must be protected from enemy detection (FM 3-13).
<b>*essential task</b>	Specified or implied tasks that must be executed to accomplish the mission. Essential tasks are always included in the unit's mission statement.
<b>event template</b>	1) A guide for collection planning; the event template depicts the named area of interest where activity, or its lack of activity, will indicate which course of action the adversary has adopted (JP 1-02). 2) A model against which enemy activity can be recorded and compared. It represents a sequential projection of events that relate to space and time on the battlefield and indicate the enemy's ability to adopt a particular course of action. The event template is a guide for collection and reconnaissance and surveillance planning (FM 34-1).
<b>EW</b>	electronic warfare
<b>*execution matrix</b>	A visual and sequential representation of the critical tasks and responsible organizations by time or for a tactical operation used as a staff tool.
<b>FA</b>	field artillery
<b>family of scatterable mines</b>	A grouping of munitions that dispense scatterable mines (scatmines) by artillery, helicopter, fixed wing, or ground launchers; there are antipersonnel and antitank mines.
<b>FASCAM</b>	family of scatterable mines
<b>FEBA</b>	forward edge of the battle area
<b>FFIR</b>	friendly force information requirements
<b>field of fire</b>	The area which a weapon or a group of weapons may cover effectively with fire from a given position (JP 1-02).
<b>fire support coordination line</b>	(NOTE: This definition is detailed.) A fire support coordinating measure that is established and adjusted by appropriate land or



amphibious force commanders within their boundaries in consultation with superior, subordinate, supporting, and affected commanders. Fire support coordination lines (FSCLs) facilitate the expeditious attack of surface targets of opportunity beyond the coordinating measure. An FSCL does not divide the area of operations by defining a boundary between close and deep operations or a zone for close air support. The FSCL applies to all fires of air, land, and sea-based weapons systems using any type of ammunition. Forces attacking targets beyond an FSCL must inform all affected commanders in sufficient time to allow necessary reaction to avoid fratricide. Supporting elements attacking targets beyond the FSCL must ensure that the attack will not produce adverse effects on, or to the rear of, the line. Short of an FSCL, all air-to-ground and surface-to-surface attack operations are controlled by the appropriate land or amphibious force commander. The FSCL should follow well-defined terrain features. Coordination of attacks beyond the FSCL is especially critical to commanders of air, land, and special operations forces. In exceptional circumstances, the inability to conduct this coordination will not preclude the attack of targets beyond the FSCL. However, failure to do so may increase the risk of fratricide and could waste limited resources. (JP 1-02).

- FLOT** forward line of own troops
- FM** field manual
- forward edge of the battle area** The foremost limits of a series of areas in which ground combat units are deployed, excluding the areas in which the covering or screening forces are operating, designated to coordinate fire support, the positioning of forces, or the maneuver of units (JP 1-02).
- forward line of own troops** A line that indicates the most forward positions of friendly forces in any kind of military operation at a specific time. The forward line of own troops (FLOT) normally identifies the forward location of covering and screening forces; the FLOT may be at, beyond, or short of the forward edge of the battle area; an enemy FLOT indicates the forward-most position of hostile forces; also called FLOT (JP 1-02).
- fragmentary order** an abbreviated form of an operation order (verbal, written or digital) usually issued on a day-to-day basis that eliminates the need for restating information contained in a basic operation order. It may be issued in sections. It is issued after an operation order to change or modify that order or to execute a branch or sequel to that order (JP 1-02).
- FRAGO** fragmentary order

<b>friendly forces</b>	
<b>information requirements</b>	Information the commander and staff need about the forces available for the operation (FM 6-0).
<b>FSCL</b>	fire support coordination line
<b>G-1</b>	assistant chief of staff, personnel
<b>G-2</b>	assistant chief of staff, intelligence
<b>G-3</b>	assistant chief of staff, operations
<b>G-4</b>	assistant chief of staff, logistics
<b>G-5</b>	assistant chief of staff, civil-military operations
<b>G-6</b>	assistant chief of staff, communications
<b>G-7</b>	assistant chief of staff, information operations
<b>GEN</b>	general
<b>*general support</b>	A support relationship assigned to a unit to support the force as a whole and not to any particular subdivision thereof.
<b>*general support-reinforcing</b>	A support relationship assigned to a unit to support the force as a whole and to reinforce another similar-type unit.
<b>Gp</b>	group (graphic only)
<b>GS</b>	general support
<b>GSR</b>	general support-reinforcing
<b>hasty operation</b>	An operation in which a commander directs his immediately available forces, using fragmentary orders, to perform activities with minimal preparation, trading planning and preparation time for speed of execution (FM 3-90).
<b>high-payoff target</b>	A target whose loss to the enemy will significantly contribute to the success of the friendly course of action. High-payoff targets are those high-value targets that must be acquired and successfully attacked for the success of the friendly commander's mission (JP 1-02).
<b>high-value target</b>	A target the enemy commander requires for the successful completion of the mission. The loss of high-value targets would be expected to seriously degrade important enemy functions throughout the friendly commander's area of interest (JP 1-02).
<b>HN</b>	host nation
<b>host nation</b>	(DOD) A nation that receives the forces and supplies of allied nations, coalition partners, and NATO organizations to be located on, to operate in, or to transit through its territory (JP 1-02).
<b>HQ</b>	headquarters
<b>HPT</b>	high-payoff target

<b>HPTL</b>	high-payoff target list
<b>HVT</b>	high-value target
<b>IAW</b>	in accordance with
<b>ID</b>	infantry division
<b>IEW</b>	intelligence and electronic warfare
<b>*implied task</b>	A task that must be performed to accomplish a specified task or mission, but is not stated in the higher headquarters order.
<b>inf</b>	infantry (graphic only)
<b>information operations</b>	The employment of the core capabilities of electronic warfare, computer network operations, psychological operations, military deception, and operations security, in concert with specified supporting and related capabilities, to affect or defend information and information systems, and to influence decision making (FM 3-13).
<b>information requirements</b>	All of the information elements the commander and staff require to successfully conduct operations; that is, all elements necessary to address the factors of METT-TC (FM 6-0).
<b>INFOSYS</b>	information systems
<b>intel</b>	intelligence (graphic only)
<b>intelligence preparation of the battlefield</b>	The systematic, continuous process of analyzing the threat and environment in a specific geographic area. Intelligence preparation of the battlefield (IPB) is designed to support the staff estimate and military decision making process. Most intelligence requirements are generated as a result of the IPB process and its interrelation with the decision making process (FM 34-130).
<b>intuitive decision making</b>	The act of reaching a conclusion that emphasizes pattern recognition based on knowledge, judgment, experience, education, intelligence, boldness, perception, and character. This approach focuses on assessment of the situation vice comparison of multiple options (FM 6-0).
<b>IO</b>	information operations
<b>IPB</b>	intelligence preparation of the battlefield
<b>IR</b>	information requirements
<b>ISR</b>	intelligence, surveillance, and reconnaissance
<b>JOPES</b>	Joint Operation Planning and Execution System
<b>JP</b>	joint publication
<b>JTF</b>	joint task force

<b>key tasks</b>	Those tasks the force as a whole must perform, or conditions the force must meet to achieve the end state and stated purpose of the operation (FM 6-0).
<b>key terrain</b>	Any locality or area, the seizure or retention of which affords a marked advantage to either combatant (JP 1-02).
<b>LC</b>	line of contact
<b>LD</b>	line of departure
<b>line of contact</b>	A general trace delineating the location where friendly and enemy forces are engaged (FM 3-90).
<b>line of departure</b>	A phase line crossed at a prescribed time by troops initiating an offensive operation (FM 3-90).
<b>LLTR</b>	low-level transit route
<b>LNO</b>	liaison officer
<b>low-level transit route</b>	A temporary corridor of defined dimensions established in the forward area to minimize the risk to friendly aircraft from friendly air defenses or surface forces (JP 1-02).
<b>lt</b>	light (graphic only)
<b>LTC</b>	lieutenant colonel
<b>LTIOV</b>	last time information is of value
<b>M</b>	mechanized (graphic only)
<b>MACOM</b>	major Army command
<b>MCOO</b>	modified combined obstacle overlay
<b>MDMP</b>	military decision making process
<b>mech</b>	mechanized (graphic only)
<b>MEDEVAC</b>	medical evacuation
<b>medical evacuation</b>	The timely and efficient movement of the wounded, injured, or ill while providing enroute medical care to and between medical treatment facilities (FM 4-02).
<b>METT-TC</b>	A memory aid used in two contexts: 1) in the context of information management, the major subject categories into which relevant information is grouped for military operations: mission, enemy, terrain and weather, troops and support available, time available, civil considerations. 2) in the context of tactics, the major factors considered during mission analysis (FM 6-0).
<b>MFR</b>	memorandum for record
<b>MG</b>	major general
<b>MGRS</b>	military grid reference system
<b>MI</b>	military intelligence

<b>*military decision making process</b>	A planning tool that establishes procedures for analyzing a mission, developing, analyzing, and comparing courses of action against criteria of success and each other, selecting the optimum course of action, and producing a plan or order.
<b>mission</b>	1) The task, together with the purpose, that clearly indicates the action to be taken and the reason therefore. 2) In common usage, especially when applied to lower military units, a duty assigned to an individual or unit, a task (JP 1-02).
<b>mission command</b>	The conduct of military operations through decentralized execution based upon mission orders for effective mission accomplishment. Successful mission command results from subordinate leaders at all echelons exercising disciplined initiative within the commander's intent to accomplish missions. It requires an environment of trust and mutual understanding (FM 6-0).
<b>mission orders</b>	A technique for completing combat orders that allows subordinates maximum freedom of planning and action to accomplish missions and leaves the "how" of mission accomplishment to the subordinates (FM 6-0).
<b>mission-oriented protective posture</b>	A flexible system for protection against nuclear, biological, and chemical contamination. This posture requires personnel to wear only that protective clothing and equipment (mission-oriented protective posture gear) appropriate to the threat level, work rate imposed by the mission, temperature, and humidity (JP 1-02).
<b>*mission statement</b>	A short sentence or paragraph describing the unit's essential task (or tasks) and purpose that clearly indicate the action to be taken and the reason for doing so. It contains the elements of who, what, when, where, and why, and the reasons thereof, but seldom specifies how.
<b>MOPP</b>	mission-oriented protective posture
<b>movement order</b>	An order issued by a commander covering the details for a move of the command (JP 1-02).
<b>MP</b>	military police
<b>MSR</b>	main supply route
<b>mntns</b>	mountains
<b>NAI</b>	named area of interest
<b>named area of interest</b>	The geographical area where information that will satisfy a specific information requirement can be collected. Named areas of interest are usually selected to capture indications of adversary courses of action, but also may be related to conditions of the battlespace (JP -102).
<b>NATO</b>	North Atlantic Treaty Organization

<b>NBC</b>	nuclear, biological, and chemical
<b>*nested concept</b>	A planning technique to achieve unity of purpose whereby each succeeding echelon's concept of operation is embedded in the other.
<b>NGO</b>	nongovernmental organization
<b>o/o</b>	on order
<b>OAKOC</b>	observation, avenue of approach, key terrain, obstacles, cover and concealment
<b>OBJ</b>	objective (graphic only)
<b>observation</b>	The condition of weather and terrain that permits a force to see the friendly, enemy, and neutral personnel and systems, and key aspects of the environment (FM 6-0).
<b>obstacle</b>	Any obstruction designed or employed to disrupt, fix, turn, or block the movement of an opposing force, and to impose additional losses in personnel, time, and equipment on the opposing force. Obstacles can be natural, manmade, or a combination of both (JP 1-02).
<b>OPCON</b>	operational control
<b>operational control</b>	Command authority that may be exercised by commanders at any echelon at or below the level of combatant command. Operational control is inherent in a combatant command (command authority) and may be delegated within the command. When forces are transferred between combatant commands, the command relationship the gaining commander exercises (and the losing commander relinquishes) over these forces must be specified by the Secretary of Defense. Operational control is the authority to perform those functions of command over subordinate forces that involve organizing and employing commands and forces, assigning tasks, designating objectives, and giving authoritative direction necessary to accomplish the mission. Operational control includes authoritative direction over all aspects of military operations and joint training necessary to accomplish missions assigned to the command. Operational control should be exercised through the commanders of subordinate organizations. Normally, this authority is exercised through subordinate joint force commanders and Service and functional component commanders. Operational control normally provides full authority to organize commands and forces and to employ those forces as the commander in operational control considers necessary to accomplish assigned missions; it does not, in and of itself, include authoritative direction for logistics or matters of administration, discipline, internal organization, or unit training (JP 1-02).
<b>operational framework</b>	The arrangement of friendly forces and resources in time, space, and purpose with respect to each other and the enemy or

	situation. It consists of the area of operations, battlespace, and the battlefield organization (FM 3-0).
<b>operational picture</b>	A single display of relevant information within a commander's area of interest (FM 3-0).
<b>operation order</b>	A directive issued by a commander to subordinate commanders for the purpose of effecting the coordinated execution of an operation (JP 1-02).
<b>*operation plan</b>	1) Any plan for the preparation, execution, and assessment of military operations. 2) Any plan, except for the Single Integrated Operational Plan, for the conduct of military operations. Plans are prepared by combatant commanders in response to requirements established by the Chairman of the Joint Chiefs of Staff and by commanders of subordinate commands in response to requirements tasked by the establishing unified commander. Operation plans are prepared in either a complete format (OPLAN) or as a concept plan (CONPLAN). The CONPLAN can be published with or without a time-phased force and deployment data (TPFDD) file. a. OPLAN--An operation plan for the conduct of joint operations that can be used as a basis for development of an operation order (OPORD). An OPLAN identifies the forces and supplies required to execute the combatant commander's strategic concept and a movement schedule of these resources to the theater of operations. The forces and supplies are identified in TPFDD files. OPLANs will include all phases of the tasked operation. The plan is prepared with the appropriate annexes, appendixes, and TPFDD files as described in the Joint Operation Planning and Execution System manuals containing planning policies, procedures, and formats. Also called OPLAN. b. CONPLAN--An operation plan in an abbreviated format that would require considerable expansion or alteration to convert it into an OPLAN or OPORD. A CONPLAN contains the combatant commander's strategic concept and those annexes and appendixes deemed necessary by the combatant commander to complete planning. Generally, detailed support requirements are not calculated and TPFDD files are not prepared. c. CONPLAN with TPFDD--A CONPLAN with TPFDD is the same as a CONPLAN except that it requires more detailed planning for phased deployment of forces (JP 1-02).
<b>operations security</b>	A process of identifying essential elements of friendly information and subsequently analyzing friendly actions attendant to military operations and other activities to: 1) identify those actions that can be observed by adversary intelligence systems. 2) determine indicators hostile intelligence systems might obtain that could be interpreted or pieced together to derive critical information in time to be useful to adversaries. 3) select and execute measures that eliminate or reduce to an acceptable level the vulnerabilities of friendly actions to adversary exploitation (FM 3-13).
<b>OPLAN</b>	operation plan

<b>OPORD</b>	operation order
<b>OPSEC</b>	operations security
<b>order</b>	A communication, written, oral, or by signal, which conveys instructions from a superior to a subordinate. In a broad sense, the terms “order” and “command” are synonymous. However, an order implies discretion as to the details of execution, whereas a command does not (JP 1-02).
<b>*overlay order</b>	A technique used to issue an order (normally a fragmentary order) that has abbreviated instructions written on an overlay.
<b>PA</b>	public affairs
<b>par</b>	paragraph (graphic only)
<b>*parallel planning</b>	Two or more echelons planning for the same operation nearly simultaneously. It is facilitated by continuous information sharing by the higher headquarters with subordinate units concerning future operations.
<b>pdr</b>	Pounder (graphic only); refers to British artillery units identified by weight of rounds.
<b>phase</b>	A specific part of an operation that is different from those that preceded or follow. A change in phase usually involves a change of task (FM 3-0).
<b>phase line</b>	A line utilized for control and coordination of military operations, usually an easily identified feature in the operational area (JP 1-02).
<b>PIR</b>	priority intelligence requirements
<b>PL</b>	phase line
<b>*plan</b>	A design for a future or an anticipated operation.
<b>planning</b>	The means by which the commander envisions a desired outcome, lays out effective ways of achieving it, and communicates to his subordinates his vision, intent, and decisions, focusing on the results he expects to achieve (FM 3-0).
<b>*planning horizons</b>	Points in time the commander uses to focus the organization’s planning efforts to shape future events. The three planning horizons are: commitment (short-range), contingency (mid-range), and orientation (long-range).
<b>PM</b>	provost marshal
<b>POTF</b>	psychological operations task force



<b>priority intelligence requirements</b>	Those intelligence requirements for which a commander has an anticipated and stated priority in his task of planning and decision making (JP 1-02).
<b>psychological operations</b>	Planned operations to convey selected information and indicators to foreign audiences to influence their emotions, motives, objective reasoning, and ultimately the behavior of foreign governments, organizations, groups, and individuals. The purpose of psychological operations is to induce or reinforce foreign attitudes and behavior favorable to the originator's objectives (JP 1-02).
<b>PSYOP</b>	psychological operations
<b>*reinforcing</b>	A support relationship in which the supporting unit assists the supported unit to accomplish the supported unit's mission. Only like units (for example, artillery to artillery, intelligence to intelligence, armor to armor) can be given a reinforcing/reinforced mission.
<b>relevant information</b>	All information of importance to commanders and staffs in the exercise of command and control (FM 3-0).
<b>risk management</b>	The process of identifying, assessing, and controlling, risks arising from operational factors and making decisions that balance risk cost with mission benefits (JP 1-02).
<b>ROE</b>	rules of engagement
<b>rules of engagement</b>	Directives issued by competent military authority which delineate the circumstances and limitations under which US forces will initiate and/or continue combat engagement with other forces encountered (JP 1-02).
<b>running estimate</b>	A staff estimate, continuously updated based on new information as the operation proceeds (FM 6-0).
<b>S-1</b>	battalion or brigade personnel staff officer
<b>S-2</b>	battalion or brigade intelligence staff officer
<b>S-3</b>	battalion or brigade operations staff officer
<b>S-4</b>	battalion or brigade logistics staff officer
<b>S-5</b>	battalion or brigade civil-military operations staff officer
<b>S-6</b>	battalion or brigade communications staff officer
<b>S-7</b>	battalion or brigade information operations staff officer
<b>sequels</b>	Operations that follow the current operation. They are future operations that anticipate the possible outcomes—success, failure, or stalemate—of the current operations (FM 3-0).
<b>*service support order</b>	An order that directs the service support of operations, including administrative movements.

<b>*service support plan</b>	A plan that provides information and instructions covering service support for an operation.
<b>SITEMP</b>	situation template
<b>shaping operations</b>	Operations that create and preserve conditions for the success of the decisive operation (FM 3-0).
<b>SOI</b>	signal operating instructions
<b>SOP</b>	standing operating procedure
<b>SP</b>	self propelled (graphic only)
<b>SP</b>	start point
<b>*specified task</b>	A task specifically assigned to a unit by its higher headquarters.
<b>SSORD</b>	service support order
<b>SSPLAN</b>	service support plan
<b>*staff estimate</b>	An assessment of the situation and an analysis of those courses of action a commander is considering that best accomplishes the mission. It includes an evaluation of how factors in a staff section's functional area influence each COA and includes conclusions and a recommended COA to the commander.
<b>standing operating procedure</b>	A set of instructions covering those features of operations which lend themselves to a definite or standardized procedure without loss of effectiveness. The procedure is applicable unless ordered otherwise (JP 1-02).
<b>supply point</b>	A location where supplies, services, and materials are located and issued. These locations are temporary and mobile, normally being occupied for up to 72 hours (JP 1-02).
<b>supporting plan</b>	An operation plan prepared by a supporting commander or a subordinate commander to satisfy the requests or requirements of the supported commander's plan (JP 5-0).
<b>sustaining operations</b>	Operations at any echelon that enable shaping and decisive operations by providing combat service support, rear area and base security, movement control, terrain management, and infrastructure development (FM 3-0).
<b>*synchronization matrix</b>	A format for the staff to record the results of war gaming and used to synchronize a course of action across time, space, and purpose in relation to an enemy's course of action.
<b>tac</b>	tactical (refers to the tactical command post)
<b>TACON</b>	tactical control
<b>tactical combat force</b>	A combat unit with appropriate combat support and combat service support assets, that is assigned the mission of defeating Level III threats (JP 1-02).

<b>tactical control</b>	Command authority over assigned or attached forces or commands, or military capability or forces made available for tasking, that is limited to the detailed direction and control of movements or maneuvers within the operational area necessary to accomplish missions or tasks assigned. Tactical control is inherent in operational control. Tactical control may be delegated to, and exercised at any level at or below the level of combatant command. Tactical control provides sufficient authority for controlling and directing the application of force or tactical use of combat support assets within the assigned mission or task (JP -102).
<b>tactical mission tasks</b>	The specific activity performed by a unit while executing a form of tactical operation or form of maneuver. It may be expressed in terms of either action by a friendly force or effects on an enemy force (FM 3-90).
<b>tactical risk</b>	Risk concerned with hazards that exist because of the presence of either the enemy or an adversary (FM 100-14).
<b>tactics</b>	The employment of units in combat. It includes the ordered arrangement and maneuver of units in relation to each other, the terrain, and the enemy to translate potential combat power into victorious battles and engagements (FM 3-0).
<b>TAI</b>	target area of interest
<b>target area of interest</b>	The geographical area or point along a mobility corridor where successful interdiction causes the enemy to abandon a particular course of action or requires him to use specialized engineer support to continue. It is where he can be acquired and engaged by friendly forces (FM 3-90).
<b>task</b>	A clearly defined and measurable activity accomplished by individuals and organizations. Tasks are specific activities that contribute to the accomplishment of encompassing missions or other requirements (FM 7-0).
<b>task force</b>	A temporary grouping of units, under one commander, formed for the purpose of carrying out a specific operation or mission (JP 1-02).
<b>task organization</b>	A temporary grouping of forces designed to accomplish a particular mission (FM 3-0).
<b>task organizing</b>	The process of allocating available assets to subordinate commanders and establishing their command and support relationships (FM 3-0).
<b>TCF</b>	tactical combat force
<b>tempo</b>	the rate of military action (FM 3-0)
<b>TF</b>	task force
<b>time phase line</b>	A line used to represent the movement of forces or the flow of an operation over time (FM 34-100).

<b>Tk</b>	tank (graphic only)
<b>TLE</b>	target location error
<b>TLP</b>	troop leading procedures
<b>TOE</b>	table of organization and equipment
<b>TPL</b>	time phase line
<b>TTP</b>	tactics, techniques, and procedures
<b>*troop leading procedures</b>	A dynamic process used by small unit leaders to analyze a mission, develop a plan, and prepare for an operation.
<b>TSM</b>	target synchronization matrix
<b>TSS</b>	target selection standards
<b>TVA</b>	target value analysis
<b>UAV</b>	unmanned aerial vehicle
<b>USC</b>	United States Code
<b>visualization</b>	see commander's visualization
<b>VTC</b>	video teleconference
<b>warning order</b>	1) A preliminary notice of an order or action which is to follow. 2) A crisis action planning directive issued by the Chairman of the Joint Chiefs of Staff that initiates the development and evaluation of courses of action by a supported commander and requests that a commander's estimate be submitted. 3) A planning directive that describes the situation, allocates forces and resources, establishes command relationships, provides other initial planning guidance, and initiates subordinate unit mission planning (JP 1-02).
<b>WARNO</b>	warning order
<b>WMD</b>	weapons of mass destruction
<b>XO</b>	executive officer

# Bibliography

## JOINT PUBLICATIONS

Most joint publications are online at <http://www.dtic.mil/doctrine/jel/>.

- CJCSM 3122.01. *Joint Operation Planning and Execution System (JOPES) Volume I* (Planning Policies and Procedures). 14 July 2000.
- CJCSM 3122.02B. *Joint Operation Planning and Execution System (JOPES) Volume III* (Crisis Action Time-Phased Force and Deployment Data Development and Deployment Execution). 25 May 2001.
- CJCSM 3122.03A. *Joint Operation Planning and Execution System (JOPES) Volume II* (Planning Formats and Guidance). 31 December 1999.
- CJCSM 3500.04C. *Universal Joint Task List*. 01 July 2002.
- JP 0-2. *Unified Action Armed Forces (UNAAF)*. 10 July 2001.
- JP 1-02. *Department of Defense Dictionary of Military and Associated Terms*. Available online at <http://www.dtic.mil/doctrine/jel/doddict/>.
- JP 3-0. *Doctrine for Joint Operations*. 10 September 2001.
- JP 3-08. *Interagency Coordination During Joint Operations*. 2 volumes. 09 October 1996.
- JP 3-60. *Joint Doctrine for Targeting*. 17 January 2002.
- JP 5-0. *Doctrine for Planning Joint Operations*. 13 April 1995.
- JP 5-00.1. *Joint Doctrine for Campaign Planning*. 25 January 2002.
- JP 5-00.2. *Joint Task Force Planning Guidance and Procedures*. 13 January 1999.

## ARMY PUBLICATIONS

Most Army doctrinal publications are available online at <http://155.217.58.58/atdls.htm>. Army regulations are produced only in electronic media. Most are available online: <http://www.usapa.army.mil>.

- AR 25-50. *Preparing and Managing Correspondence*. 05 March 2001.
- AR 310-50. *Authorized Abbreviations, Brevity Codes, and Acronyms*. 15 November 1985.
- FM 1. *The Army*. 14 June 2001.
- FM 1-02 (101-5-1). *Operational Terms and Graphics*. TBD.  
When published, FM 1-02 will supersede FM 101-5-1.
- FM 3-0. *Operations*. 14 June 2001.
- FM 3-07. *Stability Operations and Support Operations*. 20 February 2003.

- FM 3-13. *Information Operations*. 23 November 2003.
- FM 3-31. *Joint Force Land Component Commander Handbook (JFLCC)*. 13 December 2001.
- FM 3-90. *Tactics*. 04 July 2001.
- FM 6-0. *Mission Command: Command and Control of Army Forces*. 11 August 2003.
- FM 6-0 supersedes chapters 1 through 4 and 6, and appendices G, and I through L of FM 101-5. FM 5-0 supersedes the remainder of FM 101-5.
- FM 6-20-10. *Tactics, Techniques, and Procedures for the Targeting Process*. 08 May 1996.
- FM 7-0. *Training the Force*. 22 October 2002.
- FM 7-15. *The Army Universal Task List*. 21 August 2003.
- FM 22-100. *Army Leadership*. 31 August 1999.
- FM 34-130. *Intelligence Preparation of the Battlefield*. 08 July 1994.
- FM 71-100. *Division Operations*. 28 August 1998.
- FM 100-7. *Decisive Force: The Army in Theater Operations*. 31 May 1995.
- FM 100-15. *Corps Operations*. 29 October 1996.
- FM 100-14. *Risk Management*. 23 April 1998.

### **OTHER MILITARY PUBLICATIONS**

- Naval Doctrine Publication 5 (NDP 5). *Planning*. 15 January 1996.
- Marine Corps Doctrinal Publication 5 (MCDP 5). *Planning*. 21 July 1997.
- Marine Corps Warfighting Publication 5-1 (MCWP 5-1). *Marine Corps Planning Process*. 24 September 2001.

### **OTHER PUBLICATIONS**

- STANAG 1059. "Distinguishing Letters for Geographic Entities for Use in NATO." 17 April 2000.

### **NONMILITARY PUBLICATIONS**

- Facione, Peter A. Paper: "Critical Thinking: What It Is and Why It Counts," Millbra: California Academic Press, 1988.
- Heinl, Robert Debs. *Dictionary of Military and Naval Quotations*. Annapolis, Maryland: United States Naval Institute, 1988.
- Janis, Irving L. *Victims of Groupthink: A Psychological Study of Foreign Decisions and Fiascoes*. Boston: Houghton Mifflin Company, 1972.
- Klein, Gary. *Sources of Power: How People Make Decisions*. Cambridge: MIT Press, 1998.
- Paporone, Christopher R. "US Army Decision-making: Past, Present, and Future," *Military Review*, July-August 2001.

# Index

Entries are by paragraph number unless states otherwise.

## A

accidental risk, definition of, 3-75  
administrative control, definition of, F-20  
administrative instructions for preparing plans and orders, abbreviations, G-29  
    classification markings, G-39  
    expressing time, G-45  
    expressing unnamed dates and times, G-41  
    general information, G-28  
    identifying pages, G-49  
    naming conventions, G-38  
    numbering pages, G-50  
    place and direction designations, G-30  
analysis, evaluated solutions, A-18  
    solutions screened out, A-17  
analytic and intuitive decision making, combining, 1-24  
    strengths and weaknesses of, 1-25  
analytic decision making, Army's approach to, 1-20  
    definition of, 1-20  
analyze relative combat power, combat power, 3-114  
army problem solving, 1-4  
army problem solving process, analyze possible solutions, 2-53  
    compare possible solutions, 2-56  
    diagram of, 2-23  
    gather information, 2-30  
    generate possible solutions, 2-47

    identify the problem, 2-24  
    make and implement the decision, 2-58  
assign, definition of, F-15  
assumptions, definition of, 3-71  
attach, definition of, F-16  
attachments (annexes, appendixes, tabs, and enclosures), annexes, G-56  
    appendixes, G-56  
    enclosures, G-56  
    tabs, G-56  
avenue of approach, definition of, 4-29

## B

battlefield organization, definition of, 1-60  
benchmark, methods of establishing, 2-43  
branch, definition of, G-10  
    definition of, 1-67  
briefing steps, analyze situation and prepare a briefing outline, B-16  
    briefing checklist, B-22  
    construct the briefing, B-19  
    deliver the briefing, B-20  
    follow up, B-22

## C

C-day, definition of, G-41  
characteristics, authoritative expression, G-3  
    avoid qualified directives, G-3  
    balance, G-3  
    brevity, G-3  
    clarity, G-3  
    completeness, G-3

    contain critical facts and assumptions, G-3  
    coordination, G-3  
    flexibility, G-3  
    positive expression, G-3  
    simplicity, G-3  
    timeliness, G-3  
civil considerations, definition of, 4-33  
collaborative planning, definition of, 1-94  
combat power, definition of, 3-114  
combined arms rehearsal, full dress, 4-59  
    reduced force, 4-58  
command and support relationships, command relationships, F-14  
    illustration of, F-19  
    support relationships, F-23  
command relationships, administrative control, F-20  
    assign, F-15  
    attach, F-16  
    operational control (OPCON), F-17  
    tactical control (TACON), F-18  
commander, staff and subordinate interaction, description of, 3-40  
commander's critical information requirements, definition of, 3-25  
    friendly force information requirements, 3-29  
    priority intelligence requirements, 3-29  
commander's guidance guidelines, air defense, D-7  
    civil-military operations, D-11

combat service support, D-9  
 command and control, D-10  
 commander's guidance  
     during planning, D-1  
 fire support, D-6  
 information operations, D-12  
 intelligence, D-4  
 introduction to, D-1  
 maneuver, D-5  
 mobility, countermobility and  
     survivability, D-8  
 commander's intent, components  
     of, 3-16  
     definition of, 3-13  
     end state, 3-17  
     key tasks, 3-18  
     purpose, 3-19  
 commander's role in planning,  
     describe, 3-11  
     direct, 3-32  
     planning guidance, 3-21  
     visualize, 3-9  
 commander's visualization,  
     definition of, 1-34, 3-9  
 concealment, definition of, 4-29  
 concept of operations, definition  
     of, 1-61  
 constraints, definition of, 3-69  
 construct the briefing, major steps  
     in, B-19  
 contingency plan, definition of, G-  
     9  
 control measures, definition of, 1-  
     69  
 coordinating staff studies,  
     considerations of  
         nonconcurrency, A-31  
     statements of  
         nonconcurrency, A-31  
 course of action analysis, attack  
     guidance matrix, H-17  
     high-payoff target list, H-14  
     target selection standards, H-  
         15  
     target synchronization matrix,  
         H-19

course of action analysis (war  
     gaming), commander's  
     decision, 3-195  
     course of action approval, 3-  
         193  
     course of action comparison,  
         3-188  
     course of action decision  
         briefing, 3-194  
 final planning guidance, 3-  
     196  
 general war-gaming rules, 3-  
     152  
 illustration of, 3-151  
 war-gaming responsibilities,  
     3-153  
 war-gaming steps, 3-164  
 course of action development,  
     analyze courses of action (war  
     game), 4-44  
     analyze relative combat  
         power, 3-114, 4-35  
     array forces, 4-39  
     array initial forces, 3-129  
     assign headquarters, 3-142  
     assign responsibilities, 4-41  
     COA screening criteria, 3-112  
     compare COAs and make a  
         decision, 4-45  
     course of action briefing, 3-  
         146  
     course of action  
         considerations, 3-138  
     develop the concept  
         operations, 3-136, 4-40  
     generate options, 3-122, 4-36  
     illustration of, 3-113, 4-34  
     prepare a COA statement  
         and sketch, 3-143, 4-42  
 cover, definition of, 4-29  
 creative thinking, description of, 2-  
     13  
 criteria, evaluation criteria, A-14  
     screening criteria, A-13  
     weighting of criteria, A-15  
 critical reasoning, analysis, 2-10  
 cognitive skills, 2-10

description of, 2-8  
 evaluation, 2-10  
 explanations, 2-11  
 interpretation, 2-10  
 self-regulation, 2-11  
 critical thinkers, characteristics of,  
     2-12

## D

D-day, definition of, G-41  
 decide, COA comparison and  
     approval and orders production,  
     H-20  
     course of action analysis, H-  
         12  
     course of action  
         development, H-11  
     mission analysis, H-5  
 decide function, related products,  
     H-4  
 decision, decision briefing format,  
     B-4  
 decision making, definition of, 1-  
     19  
 decision making time-saving  
     techniques, general techniques,  
     3-216  
     specific time-saving  
         techniques during the  
         MDMP, 3-217  
 decision papers, approval line, A-  
     47  
     background and discussion,  
         A-42  
     coordination, A-44  
     description of, A-34  
     enclosures, A-50  
     for decision, A-39  
     impact, A-43  
     memorandum for, A-37  
     point of contact, A-48  
     purpose, A-40  
     recommendation, A-41  
     signature block, A-49  
     subject, A-38  
 decision point, definition of, 3-168,  
     G-67



factors affecting placement, G-69

decision support template, decision points, G-67

definition of, G-62

named area of interest, G-65

targeted area of interest, G-66

time phase lines, G-63

deliberate operation, definition of, 1-78

describe, commander's critical information requirements, 3-25

commander's intent, 3-13

elements of operational design, 3-12

essential elements of friendly information, 3-30

determine constraints, constraints, 3-69

determine specified, implied and essential tasks, determine constraints, 3-69

essential tasks, 3-67

implied tasks, 3-66

review available assets, 3-68

specified tasks, 3-65

task, 3-64

develop criteria, description of, 2-40

evaluation criteria, 2-42

screening criteria, 2-41

developing solutions, steps for, 2-48

digital enhancements to planning, description of, 1-116

direct support, definition of, F-23

general support, F-23

general support-reinforcing, F-23

reinforcing, F-23

**E**

effective planning, description of, 1-120

elements of operational design, listed, 3-12

essential elements of friendly information, definition of, 3-30

essential tasks, definition of, 3-67

estimates, essential qualities of estimates, E-10

generic staff estimate format, E-15

introduction to, E-1

running estimates, E-9

staff estimates, E-1

evaluation criteria, benchmark, 2-42

definition of, 2-42

five elements of, 2-42

short title, 2-42

unit of measure, 2-42

weighting, 2-44

expressing unnamed dates and times, C-day, G-41

D-day, G-41

H-hour, G-41

L-hour, G-41

M-day, G-41

N-day, G-41

R-day, G-41

S-day, G-41

T-day, G-41

W-day, G-41

**F**

facts, definition of, 3-70

field of fire, definition of, 4-29

forward and reverse planning, description of, 1-96

forward planning, 1-97

reverse planning, 1-98

fragmentary orders, warning orders, G-20

friendly force information requirements, definition of, 3-29

fundamental considerations, commander and staff, F-10

organizational principles, F-3

fundamentals of planning, build flexible plans, 1-44

commander's focus planning, 1-32

description of, 1-31

design bold plans, 1-46

keep plans simple, 1-41

planning is continuous, 1-36

planning is time sensitive, 1-39

**G**

gather information, assumptions, 2-35

description of, 2-30

facts, 2-34

opinions, 2-36

organizing information, 2-37

general techniques, increase collaborative planning, increase commander's involvement, 3-216

limit the number of COAs to develop, 3-216

maximize parallel planning, 3-216

use liaison officers, 3-216

generate options, brainstorming, 2-50

generate possible solutions, description of, 2-47

generate options, 2-49

summarize the solution in writing and or sketches, 2-52

groupthink, description of, 2-16

**H**

hasty and deliberate operations, hasty operation, 1-77

hasty operation, definition of, 1-77

H-hour, definition of, G-41

high-payoff target, definition of, H-14

**I**

identify critical facts and assumptions, assumptions, 3-71

description of, 3-70

facts, 3-70

identify the problem, description of, 2-24

implied tasks, definition of, 3-66  
 information, information briefing format, B-4  
 initial intelligence preparation of the battlefield, definition of, 3-59  
     four steps of, 3-61  
     results of initial, 3-62  
 integrating targeting into the operations process, assess, H-24  
     decide, H-4  
     deliver, H-22  
     detect, H-21  
     introduction to, H-1  
     targeting process and targeting team, H-1  
 intuitive decision making, definition of, 1-22

**J**

joint operation planning process, scope of, 1-30  
 joint planning, introduction to, I-1  
     joint operation plan format, I-15  
     joint planning concepts, I-3  
     joint planning overview, I-1  
 joint planning concepts, types of joint planning, I-5  
     types of joint plans, I-9  
 joint planning overview, deployment planning, I-2  
     employment planning, I-2  
     mobilization planning, I-2  
     redeployment planning, I-2  
     sustainment planning, I-2

**K**

key planning concepts, control measures, 1-69  
     description of, 1-59  
     forward and reverse planning, 1-96  
     hasty and deliberate operations, 1-76  
     intelligence, surveillance and reconnaissance, 1-81

nested concepts, 1-62  
 one third/two thirds rule, 1-101  
 parallel and collaborative planning, 1-90  
 planning horizons, 1-85  
 planning pitfalls, 1-104  
 risk reduction, 1-72  
 sequencing operations, 1-63  
 key terrain, definition of, 4-29

**L-M**

L-hour, definition of, G-41  
 list known critical events and decision points, decision point, 3-168  
 make a tentative plan, course of action development, 4-34  
     mission analysis, 4-25  
 matrices and templates, decision support template, G-62  
     execution matrix, G-74  
     synchronization matrix, G-72  
 matrix format, brigade or battalion conventions, F-28  
     corps or division conventions, F-27  
 M-day, definition of, G-41  
 methods of establishing, averaging, 2-43  
     current example, 2-43  
     historical precedent, 2-43  
     reasoning, 2-43  
 military aspects of terrain, avenues of approach, 4-29  
     cover and concealment, 4-29  
     key terrain, 4-29  
     observations and fields of fire, 4-29  
     obstacles, 4-29  
 military briefings, briefing steps, B-15  
     introduction to, B-1  
     types of briefings, B-1  
 military decision making process, advantages of full MDMP, 3-6

commander's role in planning, 3-8  
 definition of, 3-1  
 disadvantages of full MDMP, 3-7  
 illustration of, 3-2  
 planning in a time constrained environment, 3-202  
 reasons to restart, 3-3  
 tactical planning processes, 1-5  
     staff's role in planning, 3-34  
 mission analysis, analyze the higher headquarters order, 3-57  
     approve the restated mission, 3-102  
     civil considerations, 4-33  
     deliver a mission analysis briefing, 3-99  
     description of, 3-56  
     determine initial commanders critical information and essential elements of friendly information, 3-78  
     determine initial intelligence, surveillance and reconnaissance plan, 3-83  
     determine specified, implied and essential tasks, 3-64  
     develop the initial commander's intent, 3-103  
     enemy, 4-28  
     illustration of, 3-56  
     intelligence preparation of the battlefield, H-6  
     issue a warning order, 3-109  
     issue the commander's planning guidance, 3-104  
     mission, 4-26  
     perform initial intelligence preparation of the battlefield, 3-59  
     perform risk assessment, 3-74  
     review facts and assumptions, 3-110  
     target value analysis, H-7  
     targeting guidance, H-10

terrain and weather, 4-29  
 time available, 4-32  
 troops and support available, 4-31  
 update the operational time line, 3-87  
 write the restated mission, 3-89  
 mission command, elements of, 1-16  
 mission orders, definition of, 1-17  
 mission statement, definition of, 3-89  
 movement order, definition of, G-16

**N–O**

named area of interest, definition of, G-65  
 N-day, definition of, G-41  
 nested concepts, battlefield organization, 1-60  
     concept of operations, 1-61  
     definition of, 1-62  
 observation, definition of, 4-29  
 observation and fields of fire, observation, 4-29  
 obstacles, definition of, 4-29  
 one-third/two-thirds rule, necessity of, 1-101  
 operation order, definition of, G-13  
 operation plan, definition of, G-6  
 operational and tactical level planning, levels of war, 1-26  
 operational control (OPCON), definition of, F-17  
 operational level planning, focus of, 1-27  
     planning horizons, 1-29  
 order, definition of, G-12  
 orders production, description of, 3-199

**P**

parallel and collaborative planning, collaborative planning, 1-94  
     importance of, 1-90  
     parallel planning, 1-91

parallel planning, definition of, 1-91  
 perform risk assessment, risk management, 3-74  
 performing the military decision making process, course of action analysis (war gaming), 3-148  
     course of action development, 3-111  
     description of, 3-43  
     orders production, 3-199  
     receipt of mission, 3-45  
 performing troop leading procedures, complete the plan, 4-49  
     conduct reconnaissance, 4-47  
     description of, 4-13  
     initiate movement, 4-46  
     issue a warning order, 4-21  
     issue the order, 4-50  
     make a tentative plan, 4-24  
     receive the mission, 4-15  
     supervise and refine, 4-52  
 phase, definition of, 1-64  
 plan, definition of, G-5  
 planning, art of, 1-9  
     command & control, as part of, 1-12  
     definition of, 1-2  
     detailed command, 1-13  
     mission command, 1-15  
     nature of, 1-1  
     outcome of, 1-2  
     science of, 1-8  
 planning activities, guides to, 1-4  
 planning and plans, functions of, description of, 1-48  
 planning horizon, commitment planning, 1-87  
     contingency planning, 1-88  
     definition of, 1-86  
     orientation planning, 1-89  
     types of, 1-86

planning in a time constrained environment, advantages of abbreviating the MDMP, 3-207  
     decision making time-saving techniques, 3-215  
     description of, 3-202  
     disadvantages of abbreviating the MDMP, 3-208  
     the commander's role, 3-210  
     the staff's role, 3-214  
 planning pitfalls, applying planning techniques inflexibly, 1-113  
     attempting to forecast events too far in the future, 1-105  
     delaying planning to gain more detailed information, 1-108  
     description of, 1-104  
     planning in too much detail, 1-110  
     using planning as a scripting process, 1-112  
 plans and orders, administrative instructions for preparing plans and orders, G-27  
     attachments (annexes, appendixes, tabs, and enclosures), G-51  
     characteristics, G-1  
     examples and procedures for completing plans, orders, and annexes, G-75  
     introduction to, G-1  
     matrices and templates, G-61  
     standing operating procedures, G-59  
     techniques for issuing orders, G-22  
     types of plans, G-5  
 priority intelligence requirements, definition of, 3-29  
 problem solving and decision making, critical reasoning, 2-8  
     description of, 2-1  

**R**

 R-day, definition of, G-41  
 receipt of mission, 3-45  
     alert the staff, 3-46

gather the tools, 3-47  
 issue the initial guidance, 3-54  
 issue the initial warning order, 3-55  
 perform an initial assessment, 3-49  
 update staff estimates, 3-48  
 receive the mission, 4-15  
     allocate the available time, 4-19  
     perform an initial assessment, 4-17  
 recommended war-game methods, avenue-in-depth method, 3-173  
     belt method, 3-172  
     box method, 3-175  
 risk management, accidental risk, 3-75  
     definition of, 3-74  
     tactical risk, 3-75  
 role of the command and staff in the MDMP, illustration of, 3-42  
 running estimate, definition of, 3-39, E-9

**S**

screening criteria, acceptability, 2-41  
     categories of, 2-41  
     completeness, 2-41  
     distinguishability, 2-41  
     feasibility, 2-41  
     suitability, 2-41  
 S-day, definition of, G-41  
 select the war-game method, recommended war-game methods, 3-171  
 sequel, definition of, 1-68, G-11  
 sequencing operations, branches and sequels, 1-66  
     description of, 1-63  
     phasing, 1-64  
 service support order, definition of, G-14  
 service support plan, definition of, G-7

solving problems, description of, 2-23  
 solving problems in a group setting, description of, 2-15  
     groupthink, 2-16  
 specific time-saving techniques during the MDMP, course of action analysis, 3-229  
     course of action approval, 3-238  
     course of action comparison, 3-237  
     course of action development, 3-223  
     mission analysis, 3-218  
     orders production, 3-239  
     receipt of mission, 3-217  
 specified tasks, definition of, 3-65  
 staff estimate, definition of, 3-37  
     running estimate, 3-39  
 staff estimates, definition of, E-1  
 staff guidelines for mission analysis, air and missile defense coordinator, C-11  
     all staff officers, C-3  
     assistant chief of staff, G-1/AG (S-1), personnel, C-4  
     assistant chief of staff, G-2 (S-2), intelligence, C-5  
     assistant chief of staff, G-3 (S-3), operations, C-6  
     assistant chief of staff, G-4 (S-4), logistics, C-7  
     assistant chief of staff, G-5 (S-5), civil-military operations, C-8  
     assistant chief of staff, G-6 (S-6), intelligence, C-9  
     assistant chief of staff, G-7 (S-7), intelligence, C-10  
     chaplain, C-12  
     chemical officer, C-13  
     engineer coordinator, C-15  
     fire support coordinator, C-14  
     introduction to, C-1  
     public affairs officer, C-16

surgeon/medical officers, C-17  
 staff studies, common problems with staff studies, A-33  
     coordinating staff studies, A-29  
     staff study format, A-3  
 staff studies and decision papers, decision papers, A-34  
     introduction to, A-1  
     staff studies, A-1  
 staff study, description of, A-1  
 staff study format, analysis, A-16  
     approval line, A-24  
     assumptions, A-10  
     background, A-8  
     comparison, A-19  
     conclusion, A-20  
     coordination, A-21  
     criteria, A-12  
     enclosures, A-27  
     facts, A-9  
     memorandum for, A-4  
     point of contact, A-25  
     possible solutions, A-11  
     problem, A-6  
     recommendation, A-7  
     signature block, A-26  
     subject, A-5  
 staff's role in planning, critical tasks for staff, 3-35  
     description of, 3-34  
     staff estimate, 3-37  
 standing operating procedures, benefits of, G-59  
 structure of problems, description of, 2-19  
     ill-structured problems, 2-22  
     medium-structured problems, 2-21  
     well-structured problems, 2-20  
 supervise and refine, backbrief, 4-56  
     battle drills or SOP rehearsal, 4-61

combined arms rehearsal, 4-57  
 confirmation brief, 4-55  
 support rehearsals, 4-60  
 support relationships, description of, F-23  
 direct support, F-23  
 supporting plan, definition of, G-8

**T**

tactical control (TACON), definition of, F-18  
 tactical level planning, focus of, 1-28  
 planning horizons, 1-28  
 tactical planning processes, MDMP and TLP, 1-5  
 tactical risk, definition of, 3-75  
 tactics, definition of, 1-28  
 target value analysis, target sheets, H-9  
 target spreadsheets, H-8  
 targeted area of interest, definition of, G-66  
 task, definition of, 3-64  
 task organization, command and support relationships, F-12  
 fundamental considerations, F-1  
 introduction to, F-1  
 task organization formats, F-24  
 task organization formats, matrix format, F-26  
 outline formats, F-25  
 unit listing sequence, F-30  
 task organizing, definition of, 1-56  
 T-day, definition of, G-41  
 techniques for issuing orders, graphics, G-24  
 overlay orders, G-26  
 overlays, G-25  
 verbal orders, G-23  
 terrain and weather, military aspects of terrain, 4-29  
 military aspects of weather, 4-29

time phase lines, definition of, G-63  
 troop leading procedures, definition of, 4-2  
 description of, 4-1  
 performing troop leading procedures, 4-13  
 tactical planning processes, 1-5  
 troop leading procedures and military decision making process, 4-1  
 troop leading procedures and military decision making process, relationship between, 4-1  
 troop leading procedures steps, illustration of, 4-2  
 types of briefings, decision, B-4  
 information, B-2  
 mission, B-9  
 staff, B-12  
 types of joint planning, campaign planning, I-8  
 crisis action planning, I-7  
 deliberate planning, I-6  
 types of joint plans, CONPLAN with TPFDD, I-12  
 CONPLAN without TPFDD, I-11  
 functional plans, I-13  
 OPLAN, I-10  
 OPORD, I-14  
 types of orders, description of, G-12  
 fragmentary orders, G-20  
 movement orders, G-16  
 operation orders, G-13  
 order, G-12  
 service support orders, G-14  
 warning orders, G-18  
 types of plans, branch, G-10  
 contingency plan, G-9  
 operation plan, G-6  
 plan, G-5  
 sequel, G-11

service support plan, G-7  
 supporting plan, G-8

**U-Z**

visualize, commander's visualization, 3-9  
 war-gaming steps, determine evaluation criteria, 3-170  
 gather the tools, 3-165  
 list all friendly forces, 3-166  
 list assumptions, 3-167  
 list known critical events and decision points, 3-168  
 select a method to record and display results, 3-176  
 select the war-game method, 3-171  
 war-game briefing (optional), 3-187  
 war game the battle and assess the results, 3-179  
 warning order, definition of, G-18  
 W-day, definition of, G-41  
 write the restated mission, mission statement, 3-89