

DESIGN ■ DEVELOP ■ DELIVER ■ DOMINATE



# ARMY AI&T

ASC.ARMY.MIL

SUMMER 2020

## ARMY'S VANTAGE POINT

PEO EIS is constructing a 360-degree view of the Army's data landscape

## EVERY MINUTE COUNTS

Soldier-centered design drives RCCTO prototype development

## DREAMS OF FLIGHT

Being born without fibulae didn't stop Aimee Mullins; neither will anything else

# FIELDING THE FUTURE

## READ ARMY AL&T MAGAZINE ONLINE

For the current and past issues of Army AL&T magazine, go to <https://asc.army.mil/web/publications/army-alt-magazine/>.



For writers guidelines and to submit articles, go to: <http://asc.army.mil/web/publications/army-alt-submissions/>

To contact the Editorial Office:  
Call 703-664-5636/5633

Email:  
[armyalt@gmail.com](mailto:armyalt@gmail.com)

Mailing Address:  
DEPARTMENT  
OF THE ARMY  
ARMY AL&T  
9900 BELVOIR RD.  
FORT BELVOIR, VA  
22060-5567

**THE HONORABLE BRUCE D. JETTE**  
Assistant Secretary of the Army  
for Acquisition, Logistics and Technology  
(ASA(ALT))/Army Acquisition Executive

## EDITORIAL BOARD

**LT. GEN. CHARLES D. LUCKEY**  
Chief, U.S. Army Reserve/Commanding General (CG),  
U.S. Army Reserve Command

**LT. GEN. ROBERT L. MARION**  
Principal Military Deputy to the ASA(ALT)/  
Director, Army Acquisition Corps

**LT. GEN. BRUCE T. CRAWFORD**  
U.S. Army Chief Information Officer/G-6

**LT. GEN. EDWARD M. DALY**  
Deputy CG/Chief of Staff,  
U.S. Army Materiel Command

**JEFFREY S. WHITE**  
Principal Deputy ASA(ALT)

**ROY A. WALLACE**  
Assistant Deputy Chief of Staff, G-1

**JAMES P. WOOLSEY III**  
President, Defense Acquisition University

**DR. DAVID W. PITTMAN**  
Director of Research and Development/  
Chief Scientist, U.S. Army Corps of Engineers

**JOHN J. DANIELS**  
DASA for Plans, Programs and Resources, OASA(ALT)

**DR. PHILIP PERCONTI**  
DASA for Research and Technology, OASA(ALT)

**REBECCA WEIRICK**  
Deputy Assistant Secretary of the Army (DASA)  
for Procurement, Office of the ASA(ALT) (OASA(ALT))

**BRIG. GEN. MICHAEL J. TALLEY**  
CG, U.S. Army Medical Research  
and Development Command

**COL. GLENN DEAN**  
Deputy for Acquisition and Systems Management,  
OASA(ALT)

**RAY M. GAGNE**  
DASA for Acquisition Policy and Logistics (Acting),  
OASA(ALT)

**SANDY LONG**  
DASA for Defense Exports and Cooperation (Acting),  
OASA(ALT)

**MARGARET E. BOATNER**  
DASA for Strategy and Acquisition Reform (Acting),  
OASA(ALT)

**SGT. MAJ. JACINTO GARZA**  
Sergeant Major to the Principal Military Deputy, ASA(ALT)

**CRAIG A. SPISAK**  
Director, U.S. Army Acquisition Support Center  
(USAASC)/Director, Acquisition Career Management

**NELSON MCCOUCH III**  
Executive Secretary,  
Editorial Board, USAASC

## EDITORIAL STAFF

**NELSON MCCOUCH III**  
Editor-in-Chief

**STEVE STARK**  
Senior Editor

**MICHAEL BOLD**  
Editor

**JACQUELINE M. HAMES**  
Editor

**MARGARET C. "PEGGY" ROTH**  
Editor

**ELLEN SUMMEY**  
Editor

**MICHELLE STROTHER**  
**ASHLEY FESSLER**  
Layout and Graphic Design

Army AL&T magazine (ISSN 0892-8657) is published quarterly by the ASA(ALT). Articles reflect the views of the authors and not necessarily official opinion of the Department of the Army. Articles of the Army may be reprinted if credit is given to Army AL&T magazine and the author.

Private subscriptions and rates are available from:  
Superintendent of Documents, U.S. Government Printing  
Office, Washington, DC 20402  
202-512-1800

Periodicals official postage paid at  
Fort Belvoir, VA, and additional post offices.

POSTMASTER:  
Send address changes to:  
DEPARTMENT OF THE ARMY  
ARMY AL&T  
9900 BELVOIR RD  
FORT BELVOIR, VA 22060-5567

This medium is approved for official dissemination of material designed to keep individuals within the Army knowledgeable of current and emerging developments within their areas of expertise for the purpose of enhancing their professional development.

By Order of the Secretary of the Army:

**JAMES C. McCONVILLE**  
General, United States Army  
Chief of Staff

Official:

**KATHLEEN S. MILLER**  
Administrative Assistant  
to the Secretary of the Army  
2014102

## FROM THE AAE

### 4 FIELD THE FUTURE, SAFEGUARD THE PRESENT

Pandemic adds new dimension to readiness and modernization

## FIELDING THE FUTURE

### 8 EVERY MINUTE COUNTS

Soldier-centered design drives RCCTO prototype development

### 15 THE ARMY'S VANTAGE POINT

PEO EIS enters uncharted territory to construct a 360-degree view of the Army's data landscape

### 20 DRESS RIGHT AND COVER DOWN

The Army responds quickly to produce face coverings

### 28 VIRTUAL REVIEW

JPEO A&A gets creative during social distancing

### 34 FIELDING THE PROTOTYPE

How U.S. Army Futures Command is going direct to Soldiers around the world

### 44 EMBRACING DIGITAL ENGINEERING

New acquisition approaches keep pace with modernization



### ON THE COVER

Fielding the force for the future—modernizing the Army—amid the COVID-19 pandemic proceeds today because of the resilience of the Army Acquisition Workforce and the resilience of our industry partners. We can never lose sight of whom we serve—the Soldier.

**SUBSCRIBE**

TO RECEIVE THE PRINT VERSION OF THE MAGAZINE  
AND E-MAIL ALERTS WHEN NEW ISSUES ARE AVAILABLE.

**48** RAPID ROBOTIC REQUIREMENTS RELAY

A race to transition robotic vehicle concepts to reality

**51** FACES OF THE FORCE:  
MAJ. SAMUEL G. BUTLER

Pushing the limits

**53** EMPHASIZE SUPPORTABILITY EARLY

Unforeseen supportability issues could limit a system's availability in the field

**58** CENTER STAGE ON COVID-19

Medical Research and Development Command has multiple roles in pandemic response

**63** THE HALO EFFECT

Army rolls out simpler health records software during pandemic

**70** PRESERVING LIVES  
ON THE NEW BATTLEFIELD

Battlefield medicine adapts to emerging 21st-century threats

**78** NEW HORIZONS

Satellite constellations to power network modernization

**82** TACTICAL SOFTWARE  
'SPRINTS' FORWARD

PEO C3T delivers software improvements faster with Agile

**88** TRAINING TO DELIVERY:  
CYBERSPACE WARFARE

The Army needs carry-on-size cyberspace defense system

**92** FACES OF THE FORCE:  
LT. COL. THERESA ELLISON

From art school to 'Team Army'

## FEATURE ARTICLES

**94** AVOID BRIDGES TO NOWHERE  
The problem with temporary contract extensions known as bridge actions, and how to fix it

**101** MEASURE WHAT MATTERS  
Improved stakeholder engagement advances business

**106** ASA(ALT) AT WORK: JPEO-CBRND  
The JPEO is joint services lead for CBRN defense, medical countermeasures

**112** THE 'PITCH AND CATCH' MOVEMENT APPROACH  
49th Movement Control Battalion makes the case for increased cooperation

**118** UNDERSTANDING THE BATTLEFIELD  
Army ERDC creating advanced geospatial tools

**125** PLANNING FOR JOINT USE  
Effective joint-use planning can speed facility occupancy

## CRITICAL THINKING

**130** DREAMS OF FLIGHT  
Being born without fibulae didn't stop Aimee Mullins; neither will anything else

## COMMENTARY

**138** THE DROIDS YOU'RE LOOKING FOR  
The Army needs a thorough ontology framework to best use AI

**143** BEEN THERE, DONE THAT: AI NEEDS DATA  
Artificial intelligence has the potential to radically change the government PM's role

## WORKFORCE

**148** FROM THE DACM: LEARNING IN THE FACE OF PANDEMIC  
Army Acquisition Workforce training has continued in spite of the limitations

**152** FACES OF THE FORCE: BRANDON M. WILLIAMS  
The trifecta of career success

**154** CAREER NAVIGATOR:  
AN EDUCATION IN DISTANCE LEARNING  
Here's how the COVID-19 pandemic is changing Army education

**158** ON THE MOVE

**165** THEN & NOW: 'TO INCLUDE' DOESN'T  
How far back does DOD's curious locution go?

## From the Editor-in-Chief

**W**hen you throw a stone into a pond, it creates ripples, an expanding ring technically called a wave packet. The wave packet continues outward in a circle until it reaches shore. In short, this is how acquisition works. The Army creates a requirement and throws it into the acquisition pond, and the ripple—the product or capability—moves across the system until it gets to the user, our Soldiers. Sometimes, as in the case of operational needs statements, the ripples are fast and reach the Soldier quickly. For almost anything else, it takes years to refine the product or capability and reach the Soldier.

Hence the theme for our Summer issue: Fielding the Future. If you are a regular reader of Army AL&T, you're very aware that we talk about the future a lot. Why? Because little of what we do today affects today. But everything we do today affects the future. Right now the world is working through a pandemic. Many businesses have stopped production, but that's not true for defense. Our Army acquisition executive, Dr. Bruce D. Jette, is taking initiatives now to ensure that supply chains maintain financial stability for companies to continue producing needed systems. Considering that Dr. Jette is responsible for more than 600 programs, what we do now will affect critical production for years.

On the other side of the equation is the workforce that creates the products. Just like industry, we can't stop and let up on the education and training standards required for the defense acquisition workforce. Craig A. Spisak, the director for acquisition career management (DACM), is the Army's senior-level advocate for all Army Acquisition Workforce (AAW) matters and manages education, training and talent management for the 42,000-strong AAW. In response to the pandemic, he directed the Army Acquisition Center of Excellence to move all of its pre-command course and other contract training online, and the Training With Industry program to hold a virtual orientation for the 2020 cohort. He worked with Army students to provide them virtual instructor-led training

as Defense Acquisition University (DAU) moves online; and recognized 26 students with a virtual graduation for completing the 10-month DAU Senior Service College Fellowship.

The AAE and the DACM are examples of fielding the future. If either of them didn't act now, the ripple effect in both personnel and equipment capabilities would be devastating. Likewise, our program executive offices—where many of our Army's products are created—keep marching on. Learn about harnessing low and middle Earth orbit satellite capabilities for future network modernization in "New Horizons" on Page 78. Explore metaphysics and how it will make artificial intelligence even smarter in "The Droids You're Looking for," Page 138.

HALO isn't just a first-person shooter game. For Army medicine, HALO (Health Assessment Lite Operations) is a lifesaver. Read about what medical technology front-line units are using now in "The HALO Effect," Page 63. Finally, BattleBots, anybody? Our friends at the Combat Capabilities Development Command's Ground Vehicle Systems Center are creating requirements for future light and medium robotic combat vehicles to take them from concept to reality. Read about it in "Rapid Robotic Requirements Relay," Page 48.

These and many other great stories can be found within these pages. Even more can be found online at [asc.army.mil](http://asc.army.mil); look for the magazine link. As always, if you have a story idea, a comment, or want to submit a story for consideration, contact us at [ArmyALT@gmail.com](mailto:ArmyALT@gmail.com). We look forward to hearing from you.



**Email Nelson McCouch III**  
@ [armyalt@gmail.com](mailto:armyalt@gmail.com)

*Nelson McCouch III*  
Editor-in-Chief



### COVER UP

A Soldier wears a face cover to drive an electric power plant onto an aircraft during strategic air load operations in May in Lawton, Oklahoma. ASA(ALT)'s COVID-19 Task Force is studying the risks and challenges that COVID-19 presents to readiness and modernization. (Photo by Sgt. Amanda Hunt, 31st Air Defense Artillery Brigade)

# FIELD THE FUTURE, SAFEGUARD THE PRESENT



Amid COVID-19 pandemic, Army acquisition fights 'invisible enemy' while it prepares for a near-peer one.

When the COVID-19 pandemic emerged earlier this year, our way of life changed dramatically. The Army acquisition, logistics and technology community entered an unprecedented era. We found ourselves fighting an “invisible enemy” that, in its unpredictability, has shown us not only how critical Army acquisition is to fielding the future, but how vital we are to safeguarding the present. It has shown us the importance of planning, preparation and, most importantly, communication among our workforce, across the Army and DOD, and with our industrial base partners.

One of the early steps I took was to appoint Brian Raftery, then the acting deputy assistant secretary of the Army for strategy and acquisition reform, as our COVID-19 Task Force lead to enable a comprehensive whole-of-the-organization assessment of the Office of the Assistant Secretary of the Army for Acquisition, Logistics and Technology (ASA(ALT)), including the risks and challenges that COVID-19 presents to readiness and modernization. He and his exceptional team are working closely with the Joint Acquisition Task Force, communicating daily with colleagues throughout the Army and DOD to ensure that we are providing equipment based on established requirements when and where needed to combat COVID-19, as well as mitigating risks to the defense industrial base.

The resilience of our industry partners, including entire supply chains from prime contractors to major subcontractors to lower tiers that include suppliers of parts and raw materials, is essential in providing capabilities to the current, as well as the future, force. To better understand the health and safety issues our contractors face, I asked my COVID-19 Task Force to begin generating a daily summary of pandemic impacts to industry, addressing prime contractors and subcontractors to the lowest level where information is available.



**ON THE JOB**

A contract painter updates Sgt. Maj. John Nelson, a U.S. Army Reserve Soldier from the 416th Theater Engineer Command (TEC) supporting a U.S. Army Corps of Engineers project, in April. The project is to rehabilitate Westlake Hospital in Melrose, Illinois, into an alternate care facility during the COVID-19 pandemic. (Photo by Sgt. 1st Class Jason Proseus, 416th TEC)

What I receive—and review daily—is a report with more than 60 pages of data on all levels of the supply chain. While contractually our industry partners are not required to furnish this information, they do so readily. This demonstrates the importance of communication. The reason behind my request for this lengthy, in-depth report is to inform Army senior leaders and to assist our industry partners while ensuring the health and safety of their workforces.

For example, steps have been taken to maintain financial stability of critical defense contractors. Progress payments may be expedited for large contractors from 80 percent to 90 percent, and small business payments expedited from 85 percent to 95 percent. In addition, we are also able to change our normal payment period that a customer has to pay their outstanding bill from 30 days to 15 days, so that primes can pay their subcontractors. The Army is committed to making sure we do the right thing to help industry

resolve problems and challenges while mitigating the impact of COVID-19.

**EYES FORWARD**

As I have said on several occasions, you can't assemble armored vehicles by telephone or computer. You've got to have welders in the factory. The Army and our Soldiers are depending on those workers to deliver capabilities, and we want to ensure that they are healthy and safe in fulfilling their commitment to our men and women in uniform.

Part of my official duties and responsibilities is exercising civilian control over the entirety of Army acquisition. Not only are we responsible for programmatic oversight of the Army's 31-plus-three priority programs, we are also responsible for more than 600 other programs. That means we have a lot of industrial partners to be concerned about.

Indeed, we have industry partners who have had to temporarily close and reopen

as a result of the pandemic. There are others that have had to rethink their workspaces or disinfect them between shifts, as we have done in many of our offices. Our prime contractors tend to be larger and more capable of weathering those kinds of events. It's the smaller companies, with 20 or maybe 30 people who make cables or circuit boards or some other important component of a major weapon system, that are of more concern—if someone becomes ill and has been in close proximity with others, the entire company may lose at least 14 days in quarantine.

When something happens to a prime contractor's supply chain, we work to execute those portions of the program not dependent upon those components. We keep moving forward, as a team. We have been and will continue to be supportive of our industrial base and its supply chains to ensure that they can continue to help us procure existing weapon systems and develop new, priority systems. We are tracking each program, and all appear



to be positioned to recover without significant slippage at this writing.

### PREPARED AND RESILIENT

People often say that acquisition is a team sport, and I am reminded daily of the importance of teamwork. The ASA(ALT) team is working seamlessly with our Army and DOD counterparts to maintain readiness while combating COVID-19. We are working with our industry partners, not only to help maintain and ensure equipment readiness for the current force, but also in fielding for the future force.

I want to thank everyone in the Army's acquisition enterprise for your hard work, your dedication to our mission and your teamwork.

Always, my top priority is the health and safety of the Army acquisition workforce—all 42,000 professionals—and their families. In March, I directed supervisors to maximize telework and alternate work schedules for all but those whose work absolutely required that they be present in person to meet essential operational requirements. This ability for a large share of our team to work off-site was possible because we had the infrastructure



### WELCOME BACK

Col. Robert F. Howe II, right, commander of the 1st Medical Brigade, elbow-bumps medics returning May 11 to Fort Hood, Texas, from deployment to New York. (Photo by Sgt. 1st Class Kelvin Ringold, 13th Expeditionary Sustainment Command)

established, the software and hardware, and the foundation upon which to build on the critical nature of our work.

While this pandemic was unforeseen, we already had plans and tools in place to quickly respond to it. As an organization, we were prepared. That, really, is what fielding the future is all about—creating the conditions and putting the tools in place so that our forces of the future will be able to respond to their own crises.

No one can say what “normal” will look like when we get back to it. Nor can anyone say how long that will take. Yet the way that we execute now will enable the creation of the future that we want, and that tells a great deal about the character and resilience of the men and women of the Army acquisition enterprise.

Fielding the future—modernizing the Army—proceeds today because of the resilience of the Army Acquisition Workforce, and the larger enterprise of which we are part. We are here to serve the Soldier. 



### NO SUBSTITUTE

“You can’t assemble armored vehicles by telephone or computer,” said Jette. “You’ve got to have welders in the factory.” (Photo by Mark Cleghorn, Anniston Army Depot)



### THE VIRTUAL FUTURE

Virtual reality aids 1st Sgt. Michael Weaver, 1-31st Field Artillery Battalion, 434th Field Artillery Brigade, in taking an early look at components of the Army's new prototype LRHW at the Fires Center of Excellence, to help influence how the system is designed. (Photo courtesy of Lockheed Martin Corp.)

# EVERY MINUTE COUNTS

Soldier-centered design drives RCCTO prototype development, obtaining early and frequent feedback from the Soldiers who best understand a system's uses.

*by Nancy Jones-Bonbrest and Jessica Salmon*

**A** ground-launched hypersonic weapon with strategic reach. A Soldier-worn sensor for electronic warfare. A high-energy laser mounted on a Stryker. Though vastly different in technology and scope, these efforts have a common, critical thread: Soldier-centered design. This concept uses formal and informal Soldier touch points to obtain early feedback that can influence design and ensure an operationally effective weapon system. Soldier-centered design has made significant contributions to these and other prototyping projects now underway at the Army Rapid Capabilities and Critical Technologies Office (RCCTO).

Long-range hypersonic weapons are on track for fielding to the first Army battery in fiscal year 2023. Developers are using virtual and augmented reality to allow Soldiers to walk around and “touch” the system. This virtual interaction with proposed hardware allows for early design changes that would be costly and time-consuming to make once the prototype is built.

In the case of the new wearable electronic sensor, which is designed to alert Soldiers quickly when electronic jamming or spoofing is detected, operational users are embedded with a development team and empowered to make recommendations for improvements, which are often implemented in real time during field exercises. This effort, planned to field in 15 months, is a result of the first RCCTO Innovation Day. (See “Innovation Days: Concept, Prototype, Deliver”, Page 13.)

And for the Army's first-ever directed energy weapon, a Stryker vehicle equipped with a prototype 50 kilowatt (kW)-class laser, Soldiers are using a surrogate platform—a Stryker

with a 10 kW-class laser—to influence the design, tactics, techniques and procedures for this emerging capability well in advance of fielding in fiscal year 2022.

As RCCTO develops these and other prototypes under accelerated timelines, close and recurring collaboration with Soldiers is imperative to ensure that they deliver residual combat capabilities that meet users' needs. Many of these prototypes are predecessors to programs of record. Soldier feedback enables the design to mature before the capability is fielded on a broader scale, reducing risk for the program of record.

Even amid COVID-19 social distancing and work restrictions, RCCTO has executed Soldier touch points to continue the feedback cycle. As technology evolves at an ever-increasing pace, Soldier-centered design is the new reality for development if an accelerated timeline is to be met and a fielded weapon system is to remain relevant.

### **HYPERSONICS AND MIXED REALITY**

In the blink of an eye, a multiton truck and trailer were flipped on their side to reveal what was underneath. Secured equipment changed locations in seconds instead of hours. A bird's-eye view revealed the fixes needed and options for change.

This experience unfolded in January, when Soldiers from Fort Sill, Oklahoma, used virtual reality to take their first look at the Army's prototype Long Range Hypersonic Weapon (LRHW). This was the first of many planned Soldier-focused evaluations intended to influence system design.

The LRHW prototype, developed by the RCCTO Army Hypersonic Project Office (AHPO), is scheduled for delivery no later than fiscal year 2023. This new class

of ultrafast, maneuverable, long-range missiles will launch from mobile ground platforms, using existing Army stock.

Continuous Soldier-centered design feedback will be critical to successful fielding and operation. RCCTO AHPO has partnered with the Fires Center of Excellence at Fort Sill to execute virtual Soldier-

## **Soldier feedback is critical throughout the prototyping process to ensure the solution has informed design characteristics and provides military utility.**

centered design for critical developmental items and with the Army Multi-Domain Targeting Center, also at Fort Sill, for execution of virtual mission planning.

With an aggressive development plan, the Army isn't waiting for Soldier input until after hardware is designed and built. Instead, it is mitigating risk by teaming with industry partners and using virtual reality tools to enable collaboration with Soldiers on an early and regular basis. Within the Collaborative Human Immersive Laboratory in Denver, Soldiers from Fort Sill were able

to interact with the component hardware of the LRHW system.

While hypersonic technology is often considered futuristic and complex, the Soldiers' input focused on seemingly low-tech items that are critical to Soldiers' operational experience, such as generator placement and access, excess equipment that could be removed to save weight, generator exhaust routing and specific locations for skid plates.

In total, there were more than two dozen items listed as improvements from the initial Soldier feedback session. Some of the recommended changes will be incorporated into the first prototype, while others will inform the next generation of hypersonic weapons. Soldier recommendations have been included in the virtual model maintaining compliance with the most current design, allowing validation of Soldier suggestions.

"There were things we saw on the model they created virtually that had our recommendations applied to it," said Lt. Col. Aaron Bright, chief of the Operational Training Division of the Fires Center Directorate of Training and Doctrine. "One was the loss of some extraneous items either to make room for more useful items we wanted them to add, or to make it more transportable."

Bright said he easily got the hang of the virtual reality system after about five minutes and that the authenticity of the system was spot on.

"I didn't think the virtual reality would be as interactive nor as intuitive as it turned out to be," he said. "I was able to grab pieces of the LRHW with my hands and move them weightlessly to the side to get a better look at another part, and to better understand how the system as



## LAUNCH

The Navy and Army jointly executed the launch of the Common Hypersonic Glide Body, part of the LRHW, in a flight experiment from the Pacific Missile Range Facility in Kauai, Hawaii, in March. RCCTO is charged with delivering the prototype LRHW to a battery no later than the 2023 fiscal year. (Photo by Oscar Sosa, U.S. Navy)

a whole works. The kinds of things that would take hours with a crane and several more hours with tools, we were doing on our own in seconds.”

As the prototype is built, this ongoing Soldier feedback will help identify early design changes and offer ways to improve the operational capacity before fielding. RCCTO AHPO is planning to conduct more than 30 Soldier feedback opportunities throughout the development process as it moves toward fielding the prototype in fiscal year 2023.

“Using virtual reality and augmented reality early is essential,” said 1st Sgt. Michael Weaver, with the 1-31st Field Artillery Battalion, 434th Field Artillery Brigade.

“It allows for changes in design to be made efficiently prior to initial rate production. And the user possesses a unique knowledge base because they have spent countless hours in a variety of environmental and physiological conditions, which gives them insight on designs that may be cumbersome or conflict with other movements or actions that have to be conducted in a timely manner.”

As the COVID-19 pandemic swept the country this spring and altered many hands-on processes, AHPO worked hard to continue Soldier-centered design. To adjust, RCCTO partnered with the Fires Center of Excellence to execute virtual Soldier-centered design for critical items such as reviewing operator roles. The

team also partnered with the Army Multi-Domain Targeting Center on executing mission-planning steps virtually and laying out the overall kill-chain process digitally, including redundant command-and-control systems in support of multidomain operations.

## LASER FOCUS

The Army’s RCCTO Directed Energy Project Office is working to transition science and technology efforts to combat-capable prototypes. The Directed Energy Maneuver Short Range Air Defense (DE-MSHORAD) will field a 50 kW-class laser integrated onto a Stryker platform in fiscal year 2022. This fielded prototype will be deployed to protect divisions and brigade combat teams from unmanned

aerial systems (UAS), rotary-wing aircraft, and rocket, artillery and mortar threats. Development efforts include several Soldier touch points, including the operation of a surrogate vehicle, participation in design reviews and operational demonstration of the objective prototype. In this way, Soldier-centered design is already informing the future of fighting with lasers.

For the past few years, the Mobile High Energy Laser (MEHEL) served as a surrogate to the DE-MSHORAD prototypes by mounting a 10 kW laser system into a Stryker platform. Operating with a three-man crew, to date, the MEHEL has participated in a Joint Improvised-Threat Defeat Organization Hard-Kill Challenge event, a Joint Warfighting Assessment and multiple Maneuver and Fires Integration Experiments (MFI)—and boasts nearly 200 confirmed UAS kills during these events.

Held annually at Fort Sill, MFI includes experiments and information-gathering to determine how the systems can be used by maneuver and fires forces in operational scenarios. During MFI events of

the last four years, Soldiers trained on and operated the laser system during realistic counter-UAS missions.

“It takes about half an hour to figure out the system, and then you’re good to go,” said Spc. Brandon Sallaway, a fires support specialist and forward observer from Fort Carson, Colorado, who served on the crew piloting the laser.

Soldier recommendations for system improvements, such as controller functions and enhanced radar training and tracking, have optimized the laser weapon system design for the end user before prototyping. Soldier feedback from laser operations has resulted in improved training, target engagement and usability. These findings directly inform the DE-MSHORAD prototype design.

“The Army’s modernization strategy identifies emerging technologies like directed energy for rapid prototyping and fielding,” said Dr. Craig Robin, director of the RCCTO Directed Energy Project Office. “Soldier touch points are critical throughout the prototyping process to

ensure the materiel solution has informed design characteristics and provides military utility.”

Soldier feedback will be fully incorporated into the DE-MSHORAD prototype development. During a combat shoot-off for the prototype competitive selection process in the third quarter of fiscal year 2021, the Army intends to have Soldiers play a pivotal role employing and operating the DE-MSHORAD platforms in a field environment.

Despite the challenges presented by COVID-19, the Directed Energy Project Office continues to move forward on its prototyping and demonstration schedule. The shoot-off will provide additional insight for the final selection of the system. Preparations are underway with virtual planning. Virtual in-progress reviews with Fort Sill, where the shoot-off will occur, are replacing face-to-face meetings and keeping the team on the timeline needed.

Implementing lessons learned from DE-MSHORAD, the Directed Energy Project Office will incorporate



### HIGH-ENERGY STAND-IN

A MEHEL participates in the MFI in December at Fort Sill, Oklahoma. The laser serves as the stand-in for the 50 kW-class DE-MSHORAD system that RCCTO will field in fiscal year 2022. (Photo by Monica K. Guthrie, Fort Sill Public Affairs)

Soldier-centered design in other projects, including Indirect Fires Protection Capability – High Energy Laser, a 300 kW-class laser prototype system that will be fielded in fiscal year 2024.

## CONCLUSION

RCCTO fully appreciates the criticality of the Soldier's operational experience and is committed to soliciting and incorporating ideas and recommendations during prototype development. This concept is at the heart of Soldier-centered design and has already improved the hypersonics, directed energy systems and other emerging technology prototypes RCCTO will field in the coming years. By bringing Soldiers in early and often, RCCTO will ensure that in moving fast, it doesn't move without purpose.

For more information, go to <https://rapidcapabilitiesoffice.army.mil/>.

*NANCY JONES-BONBREST is a public communications specialist for RCCTO. She has written extensively about Army modernization and acquisition for several years, including multiple training and testing events. She holds a B.S. in journalism from the University of Maryland, College Park. She is a frequent contributor to Army AL&T; her byline most recently appeared on "The Making of a Packard," in the Winter 2019 issue.*

*JESSICA SALMON is a senior technical writer and graphics specialist for the RCCTO's Directed Energy Project Office. She has experience writing proposals for DOD, specifically for the U.S. Army Aviation and Missile Command Expedited Professional and Engineering Support Services contract vehicle. She holds an M.A. in English literature with a technical writer certification and a B.A. in English, both from University of Alabama in Huntsville.*

## INNOVATION DAYS: CONCEIVE, PROTOTYPE, DELIVER

### Tech ideas fueled by Soldier expertise add up to wins for the Army.

Beyond using Soldier-centered design for its priorities of hypersonics and directed energy the Army Rapid Capabilities and Critical Technologies Office (RCCTO) also hosts recurring innovation day events in various locations to find new technology ideas and accelerate them into prototypes that could quickly reduce near- and mid-term operational risks.

At the center of these innovation days, which unfold like commercial-style "pitch" days to identify the most promising concepts, are Soldiers and other technical experts who participate on the judging panels. This expertise, applied before selection of the proposals, helps ensure that the Army is not pursuing duplicate or unwanted technology. Even after an innovation day, Soldier feedback continues throughout the refinement of a concept and maturation of the capability.

RCCTO has held two innovation days, one in McLean, Virginia, in September 2019, and the other in Austin, Texas, in February. To qualify to participate, companies responded to a call for white paper

submissions. Input grew substantially from the first innovation day, which had 185 submissions, to the second, which received more than 700 responses. Spanning topics as diverse as sensors, autonomy, predictive maintenance, cyber, electronic warfare and fueling options, the pitches heard on innovation day are narrowed down to the most promising efforts to rapidly prototype and deliver to Soldiers. During the two events, the RCCTO-led panels evaluated more than 80 pitches.

Of the pitches heard during the events, 21 are in the process of moving forward either in concept refinement or for a possible contract award, while two are already on contract to produce a rapid prototype.

One of those on contract from the first innovation day is TRX Systems Inc., a Maryland-based small business developing a prototype dismantled electronic warfare sensor. The capability features a portable kit that enables alerts when electronic jamming or spoofing is detected and will provide a "rewind" navigation feature to

*Continued on next page*



## INNOVATION IN ACTION

RCCTO held its second innovation day in partnership with U.S. Army Futures Command and Army Applications Laboratory at the Capital Factory in Austin, Texas, in February. (Photo courtesy of RCCTO)



Continued from page 13

estimate the user’s probable current position after jamming or spoofing has occurred.

At hands-on operational events this summer and fall, Soldiers will get a chance to try out the device and provide feedback before the final prototype is designed. To do this, they’ll work side by side with engineers who are empowered to make design changes along the way. Included are representatives from the Project Manager for Positioning, Navigation and Timing, where the capability could find a home if it transitions from prototype to program of record.

“These are quick-turn adjustments, based on direct Soldier feedback while they are using the capability in an operational setting—putting those that can make changes side by side so we rapidly adjust based on that feedback,” said Rob Monto, director of RCCTO’s Advanced Concepts and Experimentation project office. “This is a 15-month effort from when we first put this technology on contract, to bringing users into the fold for feedback, to further refining the capability, to eventually delivering a new electronic warfare prototype at the Soldier level.”

The second contract resulting from the first innovation day went to Lockheed Martin Corp. after being signed in May.

Now, RCCTO is working with Lockheed Martin on its concept for a high-power, microwave-based counter-unmanned aerial system (C-UAS) interceptor, known as the Mobile Radio Frequency-Integrated Unmanned Aircraft System Suppressor, Tube-Launchable (MORFIUS-TL). Already being tested with other DOD air defense systems, this would be the first time MORFIUS-TL would be used by the Army for on-the-move counter-swarm capabilities.

To validate that MORFIUS-TL would be a good fit, RCCTO will conduct a four-part evaluation of the prototype. The evaluation is expected to culminate with a guided flight test where Soldiers would operate the full system in a field-based scenario and provide feedback on the suitability and effectiveness of the system and training materials.

The companies selected from innovation days to participate and advance their concepts represent a wide range of small, medium and large businesses, from both the defense sector and nontraditional vendor communities. For some, their 20-minute pitch was the first time they’d ever interacted with the Army or DOD.

The success of using innovation days to scout emerging technology that

## EVALUATION TIME

The second RCCTO innovation day event included leaders, technical experts and Soldiers from across Army organizations to serve on panels. They were grouped, based on technology topic, to evaluate the 38 pitches selected from more than 700 white paper entries. (Photo courtesy of RCCTO)

could make a difference on the battlefield in a one- to three-year time frame also depends on Soldier participation early and often. Maj. Brian Owens, a cyberspace operations officer with the 915th Cyber Warfare Battalion, Army Cyber Command, served as a panelist for the cyber-focused pitches during Innovation Day 2. He said providing operational feedback before a technology is transitioned into a weapon system is crucial.

“Being in a venue like this, and being able to actually provide insight into what may come to be a new capability that could be fielded, has tremendous value,” Owens said. “To be able to shape it at this early stage, and say ‘This is how we can apply it, this is how we can shape the battlefield,’ if you will, it’s priceless.”

Other concepts advancing from innovation days are in the areas of command-and-control for multidomain operations, resilient communications, counter unmanned aerial systems and advanced defensive and offensive cyber protection.

RCCTO plans to hold a third innovation day in late summer.

—NANCY JONES-BONBREST



# THE ARMY'S VANTAGE POINT

PEO EIS is in uncharted territory, constructing a 360-degree view of the Army's data landscape.

*by Ellen Summey*

“I don't think there is one single leader we have briefed this to who hasn't said, 'This will change the Army,' ” said Col. Harry Culclasure, director of the Strategic Initiatives Group at the Program Executive Office for Enterprise Information Systems (PEO EIS). He leads the team responsible for the Army Vantage data analytics platform, which is undertaking a pretty challenging effort: compiling, verifying and visualizing the Army's vast troves of data.

“I came in to this project in the late spring of 2019, into what was the Army Leader Dashboard,” Culclasure recalled. “At that time, it was really a senior leader dashboard for giving readiness data. I think, particularly through our strong senior leader participation, including bringing in Dr. [David] Markowitz [assistant deputy chief of staff, G-8] as our functional [lead], it has really evolved into an all-leader data analytics platform, for all leaders to make decisions, not just the senior leaders of the Army.”

Markowitz, who is also the chief analytics officer of the Army, believes the platform is already establishing its role in the broader Army. “[Vantage] is a foundational layer of our Title 10 ability to manage the Army,” he said. “It is a key enabler of the Army's data strategy, of where we're trying to get more broad, Armywide data integration to make Army data available to the Army. This is a key tool set to get us there quickly.”

## **A 'COLONEL FRIENDLY' INTERFACE**

First, let's establish its technical credentials. Army Vantage is an enterprise data analytics platform that connects to and draws data from new and legacy systems in any form, at any scale. It is a commercial solution, configured to meet the Army's needs and procured under DOD Instruction 5000.74 using the software-as-a-service model. The platform is hosted in the cloud with authority to operate on the U.S. Army unclassified (NIPRNET) and classified (SIPRNET) networks. It supports advanced analytics, collaboration, metadata management, reproducibility, scalability and role-based security, while also reducing the technical barriers to entry.

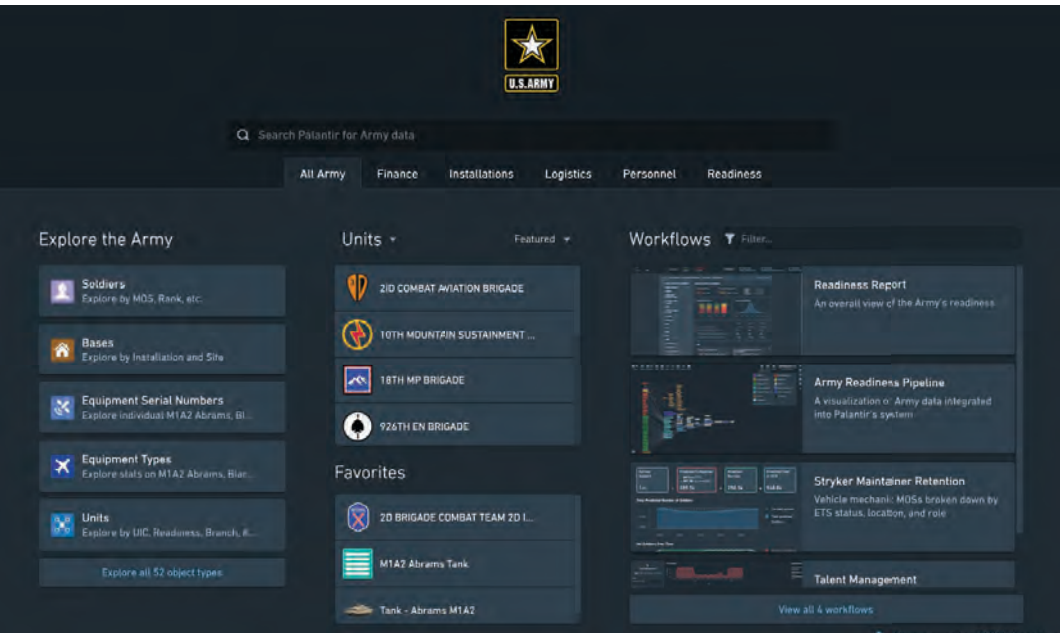

### VANTAGE AT WORK

Army Vantage uses data from a wide array of sources to create a robust Soldier profile. This image gives just a hint of why the program has Army leaders excited. (Image courtesy of PEO EIS)

To illustrate that final point, “I find it surprisingly easy to use,” said Col. Kyle Jette, the platform’s lead data scientist. “One of my jokes is that the data analytics tool in the platform is ‘colonel friendly.’ If I can use it, then most people—who are more technically savvy than I am—are in great shape. It’s intuitive and easy to use, and we’re doing things on our team to make it even more approachable.”

Markowitz agreed, and said he has seen data analysts eager to explore the platform. “What has surprised me has been the analyst layer, which is this kind of middle-tier user who wants to do data analytics and push the edge,” he said. “They just run with it. That layer has just appeared, kind of out of nowhere.” He credits the intuitive interface and data management tools with this ease of adoption. “The barrier to entry is much lower than your traditional kind of data platform,” Markowitz explained. “I think it’s rapidly building a skill set and a community within the Army to bring about the chief’s vision of an information-age Army.”

### WHAT’S UNDER THE HOOD?

Army leaders at all echelons have been enthusiastic about providing their data to the platform’s data capture teams and have embraced Vantage as a way to solve problems within their own organizations. However, Jette thinks they have just begun to scratch the surface. “There is a continuum of complexity of use or complexity of problems you could address with this platform,” he said. “To be honest, we’re all thinking kind of small right now.”

Automating ad hoc reports and routine work can save the Army a lot of time, but that’s only a small portion of the platform’s capability. “There are many higher orders of thinking and analysis, and this platform has yet to rev up the RPMs,” Jette explained. “There’s modeling, there’s predictive analysis and other things this tool can do, but right now, we’re all just kind of ‘oohing and aahing’ over some of the smaller, less complex things.” It’s a facet of human psychology that car salesmen know well: No matter how much horsepower is under the hood, most people

start by checking out the sunroof and the leather seats. Kicking the tires, so to speak.

Markowitz agrees that more advanced data analysis will be done in due time, and he also sees the potential for data integration and sharing. Among those more complex tasks are artificial intelligence (AI) and machine learning (ML). “All the artificial intelligence and machine learning tools are based upon a larger reservoir of data for those tools to learn, and Vantage provides that,” he said. “Vantage has the capacity to host some of those AI and ML tools, but probably more importantly, has the ability to integrate the data and pass it to those who need it, where that type of learning can be done.”

### THE ROAD AHEAD

“I think the data EXORD [Executive Order 009-20, Army Data Plan Implementation] has processes identifying the need for institutional change,” Markowitz said. “I would not call institutional inertia a roadblock, but it’s a lot of work the Army needs to get done. As we’re starting

**“Army Vantage is the way ahead for the Army. It represents a significant step forward in the Army’s efforts to modernize the way we use ‘big data’ across multiple systems.”**

to expose the broader data integration needs of the Army, from warfighting to intelligence, to enterprise IT, to the business areas, it’s giving us new insights of the larger road ahead. It’s going to be a long and productive journey.”

Jette agrees, and he believes that the Vantage platform can be a large part of the solution over the course of that journey. “What makes me giddy is the potential for this higher-order thinking,” he said. “I would love to see the full potential of the modeling and predictive stuff. I worked in programming for a long time at the Pentagon, and every leader wants to know, ‘What if I took \$100 million out of training and gave it to equipping? What would that do? What if I took \$500 million out of personnel and gave it to operations and maintenance? What would that do?’ And no one really knows. It’s mostly conventional wisdom and slideshow presentations. That level of data-driven insight is something this tool can enable.”

He envisions a massive budget model that could predict what happens to the Army’s projects and programs when funding is

reallocated, or when it operates under a continuing resolution. “Those things are possible,” Jette continued, “but only if you have the data in your environment and you trust it.”

“What is really cool to me is the dimension and reach that this platform has,” said Army Vantage product lead Miranda Coleman. “To not only be able to do those money drills at the headquarters level or the Pentagon level, but to go down to the lowest levels of the Army to give visibility into those exact same things. To be able to provide a tool that touches so many users at so many echelons, that’s exciting to me.”

It may feel, at times, that the Army’s business processes are driven almost entirely by ad hoc reports and slideshow presentations, but Coleman is optimistic about the future. “We are no longer being constrained by the old way of doing things through slideshows and feeding static data,” she said. “We’re leaning forward and finding new ways to solve problems by using authoritative data and analytics. We are working down in the corps and the divisions and the units, and with company commanders, and getting their feedback. We’re making sure that this solution and data analysis are beneficial to them and can make their time more efficient. We are



#### DATA SLICE AND DICE

According to those who have seen Army Vantage, the Army has hardly scratched the surface of what can be accomplished. Shown here, the program displays sample unit readiness data, which is based on a variety of factors. (Photo by the author)

working to give them more hours in the day to focus on readiness and training, and making sure their units are ready.”

### OUT FOR A TEST DRIVE

“Our fielding process has not been the standard fielding process,” Coleman said. “A lot of people are used to those static fielding plans, but this has not been that process.” It was a story of being in the room with the right people at the right time. “We did a Vantage demo to a group of incoming corps and division commanders,” she recalled, “and Lt. Gen. [Michael “Erik”] Kurilla [commanding general of the XVIII Airborne Corps] happened to be one of those people. He and Maj. Gen. [James J.] Mingus [commanding general of the 82nd Airborne Division] offered up the 82nd 18th Airborne Corps to be our pilot.”

Beginning in September 2019, the Army Vantage team sent trainers and developers to spend three days each week embedded with the 82nd Airborne Division. They worked to understand the organization’s processes, ensure that the data was correct, and work hand in hand with Soldiers to make sure the platform was not only usable but actually helpful. “Army Vantage is a game changer at the company, troop and battery level,” Mingus said. “The system is proactive vice reactive, with thousands of disparate data sources now at our tactical level and senior leader fingertips.” In an information paper dated Feb. 25, 2020, the 82nd noted its belief that Vantage “is both valuable and mature enough for Armywide deployment.” The report acknowledges that the platform’s usefulness relies entirely on the accuracy of the data in the underlying authoritative sources. Despite that limitation, however, “it is constantly improving in real time and has unlimited application potential across the force once it is fully functional.”

### CONCLUSION

In the early days of what was then the Army Leader Dashboard, the PEO EIS team saw the potential for this solution to change the way the Army does business. “That still is our vision,” Coleman said.

**Army Vantage is an enterprise data analytics platform that connects to and draws data from new and legacy systems in any form, at any scale.**

“We’ve been working on some small-scale data-sharing with other systems and data source owners, while also trying not to bite off more than we can chew. But it is our vision that this becomes a common data platform for the Army, and that we are able to pull in all this data, piece it together, and then to provide it to other folks who might need it [for example, an Army enterprise resource planning system], without having to spend the time and money of creating those system interfaces.”

Markowitz also has his eyes on the future of Army Vantage. “I think it will fill two critical roles,” he said. “First, I think it is a tool that has lowered the barrier for data analysts and the data community within the Army. We see them gel around [this platform] and then build their skill sets to be better data analysts and understand the Army’s data, and to help the Army with its own decisions and its own data

management. Second, it’s the tool itself and the type of visualization it’s hosting, the mechanics of it. I think those are the two kind of longer-term benefits we’re going to continue to see from the program.”

According to Mingus, it will also create new efficiencies for Army, allowing users to make decisions with the most up-to-date information. “Army Vantage is the way ahead for the Army,” he said. “The system represents a significant step forward in the Army’s efforts to modernize the way we use ‘big data’ across multiple systems. Mission command requires shared understanding at all levels.”

Whatever the future holds for Army Vantage, one thing is clear: It has been an unconventional effort in nearly every sense of the word. While most acquisition programs follow an established road map to success, the Strategic Initiatives Group and PEO EIS have often had to blaze their own trail to make this vision a reality. With strong support from the Army’s senior leaders and their industry partners, Army Vantage is creating a 360-degree view of the Army’s data landscape.

---

*ELLEN SUMMEY provides contract support to the U.S. Army Acquisition Support Center at Fort Belvoir, Virginia, for SAIC. She holds an M.A. in human relations from the University of Oklahoma and a B.A. in mass communication from Louisiana State University. She has more than a decade of communication experience in both the government and commercial sectors. She won an ALTie award for her article “Army Leader Dashboard: Creating Insight-Driven Decisions” in the Summer 2019 issue before becoming an editor at Army AL&T.*

## BLAZING A TRAIL

“In the beginning, we never thought that people would take to this the way they have,” said Army Vantage product lead Miranda Coleman. “It was kind of an uphill battle at first, when we had [then-Army Chief of Staff] Gen. Mark A. Milley saying he wanted us to visualize ‘all Army data.’ Well, that’s a monumental thing to think of doing. No one had ever attempted it.”

Coleman, who has been with the project since its inception, has also been deeply involved in the competitive prototyping processes the Program Executive Office for Enterprise Information Systems (PEO EIS) has employed. The competition began in June 2018, when 28 companies were invited to demonstrate their commercial capabilities to meet the Army Vantage requirement. On Aug. 15, 2018, Army Contracting Command – New Jersey (ACC-NJ) awarded five vendors fixed-price agreements for Phase 1 prototyping through an other-transaction agreement (OTA). ACC-NJ then invited two of the five vendors to continue the prototype process through an award of the fixed-price option for Phase 2 on Dec. 21, 2018. ACC-NJ invited one vendor to continue Phase 2 on June 26, 2019, followed by a fixed-price extension on Aug. 23. The extension allowed the Army to continue to use Army Vantage as a service, add 500 designated users and process the authority to operate for the DOD network. Finally, a production other-transaction agreement was awarded on Dec. 13, for up to four years (one base year and three option years) for Army Vantage.

“A challenge, which I think we’re overcoming, is that no one had done this before in the way that we’ve done it,” Coleman explained—“prototyping and using the OTA, moving as quickly as we’ve been moving. Our process of iterating with folks and not going in with set requirements and standards has been challenging at times, but people are starting to come around to understand that you can keep iterating and changing until you get to a solution that you want.”

“There is no playbook, no precedent that I’m aware of, that you can read and understand how we should be taking this on,” agreed Col. Kyle Jette, lead data scientist for the program.

“We’ve been extremely lucky,” Coleman added, “between having Ms. [Chérie] Smith as our PEO [program executive officer], having Dr. Markowitz as our functional, Gen. McConville, and Gen. Milley when he was the chief of staff. At the corps level, too, with Lt. Gen. Kurilla and Maj. Gen. Mingus—having those senior leaders believe in this effort and having their organizations embrace it has been very helpful. So many leaders are making it a priority for their folks to share their data with Col. Jette’s team, who then verify that the platform is faithfully representing the original data and make sure that what those leaders are seeing is accurate and trustworthy.”

“There were folks, initially, who did not want to change the way the Army was doing business,” said Col. Harry Culclasure, director of the Strategic Initiatives Group at PEO EIS. “In the last several months, many of them have now seen the potential of this platform, and all of a sudden, Miranda is getting dozens of calls a day about having access and being a part of one of the lines of effort.”

And the calls keep coming with requests to help with real-world problems. Army Vantage is in the process of building a COVID common operating picture, or “display,” working closely with G-3, G-4, U.S. Army Materiel Command, the Army Surgeon General’s Office and the Defense Health Agency’s COVID-19 task force. The display is pulling authoritative data from multiple sources to provide an overview of personnel with confirmed cases, the status and location of medical equipment (personal protective equipment, test kits, ventilators, etc.), medical capacity, and unit readiness based on the number of infected Soldiers.

—ELLEN SUMMEY

*“We’re leaning forward and finding new ways to solve problems by using authoritative data and analytics.”*

## FROM PARACHUTES TO MASKS

Parachute riggers with 1st Special Forces Group (Airborne), Group Support Battalion, sew surgical masks March 31 for medical patients at Joint Base Lewis–McChord. The Soldiers are well versed in quality control techniques and complex assembly lines. (Photo by Sgt. Joe Parrish, 1st SFG (A))



A woman in a military uniform is shown in profile, wearing a white face mask and white gloves. She is focused on a task in front of her, possibly a laboratory or medical setting. The background is a chain-link fence. The text 'DRESS RIGHT AND COVER DOWN' is overlaid on the left side of the image.

# DRESS RIGHT AND COVER DOWN

The Army responds quickly to the face-covering challenge with characteristic ingenuity.

*by Margaret C. Roth*

**I**t was March 27 and the United States had just passed the 100,000 mark in reported cases of COVID-19 infection. It was now leading the world in number of cases. As terrifying as the virus is, the nation's attention was riveted on the inadequate supply of protective face covers to stem the transmission. Online retailers and local home improvement stores, super centers and drugstore chains everywhere had been sold out for the past two months, overwhelmed by the rush to buy facial protection once the coronavirus had become world news.

The actual need for masks varied—there was no question that health care workers needed N95 respirator masks and disposable surgical masks, whereas the U.S. surgeon general said the average citizen did not need to wear a mask and explicitly discouraged the public from buying them for general use as recently as Feb. 29. But regardless of the true need, the demand was in the millions for all kinds of face coverings. The need and the demand only grew more acute as the pandemic's toll escalated in March.

At opposite ends of the country, solutions came quickly. They came from a seemingly unlikely source, a community of special operations paratroopers at Joint Base Lewis-McChord, Washington, and a more established group of experts in charge of designing combat clothing, uniforms and individual protective items for Soldiers at Natick, Massachusetts. And those are just two examples of how numerous Army communities have applied their professional expertise and personal dedication to help relieve the pressure of supplying specialized facial protective equipment for medical personnel and more ordinary face covers for going out in public.

As of May 21, the 1st Special Forces Group (Airborne) (1st SFG (A)) at Joint

Base Lewis-McChord south of Seattle had made more than 8,000 total face covers in three different designs: an adult disposable version, a pediatric disposable version and a cloth reusable version. In addition, it put its 3D printing capabilities to use producing face shields for personnel at Madigan Army Medical Center, located on the base. Madigan is the Army's second-largest medical treatment facility.

**“During this crisis, it is crucial for the security of the nation to keep our Soldiers protected, healthy and ready to support COVID-19 response efforts and national defense.”**

At Natick, home to the U.S. Army Combat Capabilities Development Command Soldier Center (CCDC SC), the Soldier Protection and Survivability Directorate has led the production of camouflage face covers, with an initial quantity of 10,000 to outfit Soldiers in basic training at Fort Benning, Georgia. The first of those masks arrived at Fort Benning in late April. As a result, not only has the Army been able to resume basic training and other activities during the pandemic, but face covers will become a permanent addition to Army gear.

The Soldier Center's knowledge and expertise—notably in prototyping, testing, materials and textiles, and human factors—enabled the rapid design and development of six prototypes for face covers, followed by testing and then the selection of one prototype that Soldiers had rated highly for immediate development. CCDC SC also selected a second, also well-received prototype, for further development as a more permanent Army solution, in coordination with the Program Executive Office (PEO) for Soldier. PEO Soldier's Project Manager for Soldier Survivability will produce what are being called Army Face Covers in high volumes for military personnel.

“CCDC SC's concentrated efforts allowed Project Manager Soldier Survivability to rapidly award production contracts to procure both the Type I and Type II face covers for Soldiers,” said Ken Ryan, chief of the Warfighter Protection Branch, Soldier Protection and Survivability Directorate at CCDC SC. The Army Face Cover's technical data package was transitioned to the Defense Logistics Agency Troop Support to support the Army's sustainment demands.

#### **EYE TO EYE WITH OPPORTUNITY**

The cloth face covers meet the intent of the Centers for Disease Control and Prevention (CDC) that people cover their mouth and nose when they go out in public, or when it is not possible to meet social distancing protocols, to prevent the spread of COVID-19. Secretary of Defense Dr. Mark T. Esper on April 5 directed the wearing of cloth face covers by anyone on DOD property, installations and facilities “when they cannot maintain six feet of social distance in public areas or work centers.”





### SUPPLY DROP

Lt. Col. Jacob White, commander of 2nd Battalion, 58th Infantry Regiment, talks with E Company Soldiers at Fort Benning after they received cloth face coverings from CCDC SC. The center has led the Army's production of cloth face coverings to outfit Soldiers. (Photo by Markeith Horace, Fort Benning Public Affairs)

According to the CDC, the cloth face covers may reduce the risk of someone who shows no symptoms of infection spreading droplets from their exhaled breath into their immediate environment (“My cover protects you; your cover protects me”). They do not protect the wearer from inhaling particles, or from other respiratory irritants.

The response to the obvious need for such face covers was as swift as it gets. “The entire process of designing prototypes, material selection and down-selection to final face covering, to ramping up our in-house production team was completed in about 10 days,”

said Molly Richards, a research chemical engineer on CCDC SC’s Chem-Bio Innovative Material and Ensemble Development Team. The production team, consisting of employees across three of the center’s six directorates, was making several hundred of the Army face covers a day, she said in mid-May.

In late March, the need for personal protective equipment (PPE) could not have been more pressing than in Washington state, where the first U.S. cases of COVID-19 infection were treated and the number of confirmed new cases had climbed to over 400 a day. Within the 1st SFG (A) Group Support Battalion, “there



### ENDURING COVER

Pictured here are the two designs prototyped by the CCDC SC for everyday use by Soldiers. CCDC SC chose the one at left, Type I, for immediate development. Type II, at right, has been further developed in coordination with PEO Soldier and will be produced in volume as a more permanent Army solution. Both designs have two-ply, nontreated fabric, an elastic cord strap with adjustable barrel lock and shapable nose bridge. Type I has a pleated design and an inner pocket to add filter material. (Photos by David Kamm, CCDC SC)

was a growing discussion on converting idle 3D printing capacity within military units to support producing COVID-19 items,” said Lt. Col. Christopher S. Jones, battalion commander.

At its 2-year-old and still-growing fabrication facility, known as Makerspace, the 1st SFG (A) is accustomed to prototyping one-off parts for special operations requirements, such as 3D-printed tracheas to use in simulators for field medical training and navigation boards used by special operators during high-altitude, low-opening parachute drops.

But by March 25, the much less exotic standard face cover emerged as the most pressing need. Madigan and affiliated facilities together serve more than 100,000 active-duty service members, their families and retirees. The 1st SFG (A) parachute riggers would repurpose the five lightweight sewing machines they used to repair parachutes to assemble surgical masks. Battalion

personnel would use their 3D printing resources and expertise to create prototypes for reusable respirator masks and face shields.

On March 31, 15 paratroopers began full production of the face covers.

“We are just trying to use the organic capabilities that 1st SFG (A) has in new and innovative ways in an effort to help keep our Soldiers, community and country safe in the fight against COVID,” said Master Sgt. Taylor Cathey, the battalion’s senior airdrop operations NCO.

### ABOUT FACE

The 1st SFG (A) wanted to honor the tradition of Special Operations Forces “to thrive in ambiguous situations and solve hard problems,” Jones said. “Everyone just pitched in immediately.”

Makerspace has 3D printers and cold metal transfer mills. Prototyping uses mostly polylactic acid (PLA), a natural polymer that comes from renewable resources such as cornstarch or sugar cane and is a substitute for petroleum-based plastics.

Initially the discussion of how the 1st SFG (A) could best contribute zeroed in on ventilator components, and the U.S. Special Operations Command put out a request for ideas via its Vulcan platform. The unit also prototyped and discussed the possibility of making N95 respirators, but learned of considerable difficulties involved because of limited availability of the three-layer filters.

It was increasingly clear that the most urgent need was to supply health care facilities with PPE. The private-sector Providence Health System, headquartered in the Seattle suburb of Renton, Washington, had just launched its 100 Million Mask Challenge, enlisting manufacturers of various kinds.

The battalion got input from the medical community through both official and informal channels; both Jones and Group Surgeon Col. Rodd Marcum are married to registered nurses. The objective would be to make Madigan's versatile surgical and sterilization wrap into a simple protective mask that patients could wear to reduce the risk of transmitting respiratory disease to other patients and clinical staff, or that staff could wear to extend the functional life span of critical PPE in acutely short supply.

But before a needle could touch cloth, standards had to be set. Besides the materials that the Soldiers of the 1st SFG (A) would use, there were the questions of how to put together a face cover most efficiently, and how to ensure a clean environment in which to make them.

The process—"getting all the material, getting the personnel together and really developing the product"—was the biggest challenge facing them, Cathey said. "How were we going to do it in assembly-line fashion so that we utilize the minimum number of people to do the maximum amount of masks each day? It's been definitely a learning curve. We've got it pretty well refined now."

### SAFETY CHECK

In short order, Chief Warrant Officer 3 Jeremy Vann, allied trades warrant officer for the 1st SFG (A), had printed prototype face shields out of PLA, using his personal 3D printer based on designs from the NIH 3D Print Exchange and following guidance from the U.S. Food and Drug Administration and the U.S. Army Medical Research and Development Command (MRDC), as the Army focal point and sponsor for COVID-19 projects. Jones and his team put together a prototype face cover, using a sewing machine, to discuss with Marcum, his wife, who works at Madigan, and the group executive officer.

With guidance from the group's preventive medicine team, the Soldiers set out to

ensure that "work-site processes met infection control standards," including how to properly sanitize the workstations before beginning full-scale production, how to monitor the health status of personnel, and production tracing, similar to how parachutes are packed and tracked for quality assurance and control.

"They're very particular on safety, very particular on managing and oversight of who packs the chutes," Jones said. "That transitions very easily to making the masks and figuring out, if something goes wrong, what went wrong in the process."

The group developed the process in coordination with Chief Warrant Officer 3 Richmond Minton, the senior allied trades technology NCO on the I Corps G-4 (logistics) staff, and the 308th Brigade Support Battalion, which has access to additive manufacturing equipment. Minton, in turn, worked to get MRDC approval for the process, Jones said.

The masks and face covers are intended solely for Madigan and its service network. For the three cloth masks, tested and approved by Madigan's industrial hygiene

**“During this crisis, it is crucial for the security of the nation to keep our Soldiers protected, healthy and ready to support COVID-19 response efforts and national defense.”**



### MASKED AND READY

A parachute rigger with 1st Special Forces Group (Airborne), Group Support Battalion, sews surgical masks for medical patients March 31 at Joint Base Lewis–McChord. The battalion jumped to use available resources to produce masks in response to the COVID-19 pandemic. (Photo by Sgt. Joe Parrish, 1st SFG (A))

department, the material is hospital-provided sterilization wrap with a bacterial filtration efficiency of 98.9 to 99.9 percent.

“We will continue to make masks as long as there continues to be a need,” and will continuously refine the product designs and production process with feedback from medical employees, said Cathey. “If production numbers meet the demand identified by hospital leadership, it is feasible that masks might be redirected to other priority locations and staff,” Jones said, “consistent with the

updated recommendations to wear cloth face coverings when physical distancing is not feasible.”

### BASIC NEEDS

When Esper authorized DOD personnel to wear cloth face covers, the U.S. Combat Capabilities Development Command Soldier Center was the obvious candidate to develop an Armywide solution. The center represents one of eight major areas of competency for CCDC, a subordinate command of U.S. Army Futures Command.

Like every other organization with the coronavirus in its midst, the Army had to regroup to consider how to combat it. Among other actions, in early April, the Army put a two-week hold on sending recruits to basic training. But training new recruits couldn’t stop forever.

“During this crisis, it is crucial for the security of the nation to keep our Soldiers protected, healthy and ready to support COVID-19 response efforts and national defense,” said Douglas Tamilio, director of the Soldier Center. “We responded very quickly to make an Army-acceptable solution to the requirement for face coverings.

“Our job is the research, development and early engineering of the solution and building a technical data package,” Tamilio explained, whereas production is in the hands of PEO Soldier and the Defense Logistics Agency. “We leveraged all our resources here, and a talented group of our employees worked hard to rapidly make the initial 10,000 face coverings to support training at the Maneuver Center of Excellence at Fort Benning,” he said.

### QUICK TIME, MASK

“Resources” covers a rich landscape of expertise and experience at CCDC Soldier Center: clothing designers, material scientists, fabric workers and equipment specialists, among other specialties. They are “experts at the design and fabrication of prototype clothing, individual protection items and equipment, personnel airdrop systems, cargo airdrop, and soft-wall shelter systems, along with other military-unique textile-based items,” said Annette LaFleur, who leads the Design, Pattern and Prototype Team.

In response to the enormous need for face covers, “designers quickly brainstormed, sketched, patterned and fabricated prototypes in one weekend, while material

## “The entire process of designing prototypes, material selection and down-selection to final face covering, to ramping up our in-house production team was completed in about 10 days.”

scientists, textile technologists and engineers coordinated the test and evaluation of potential materials,” she said.

LaFleur’s team developed an array of potential prototype systems encompassing six designs, taking into account integration with eyewear and helmets, the face cover’s ability to stay in place and adjustability to various head sizes and face shapes, she said.

The Human Factors Team conducted an assessment of the prototypes using local Soldier research volunteers. The design that the Soldier Center selected for fabrication had the highest Soldier acceptance, with consideration for ease of manufacturing. A second design, also highly accepted, is being further developed rapidly as a more permanent Army solution.

Having selected the materials to use, the team rapidly cut and sewed quantities of the six designs to get Soldiers’ feedback. The design selected was ready for use without improvements.

### PIVOT TO PRODUCTION

While the Soldier Center’s own personnel took on the job of fabricating the first 10,000 face covers, its established role in developing solutions is to design and prototype them, not produce the items. The Army prepared to segue into long-range production using the procurement processes established for other textile-based items, LaFleur said.

“There is a wide base of cut-and-sew manufacturers within the USA, which the Army uses to manufacture textile-based items for the warfighter,” she explained. As with the production of established clothing items, all materials will comply with the Berry Amendment requirement that they be sourced and manufactured in the United States. “We also have military-specific design considerations” of form, fit and function, LaFleur said.

Unlike many other Army uniform items, the face coverings will not be treated with extra chemical finishes or processes, she said. “There is no bug repellent or similar treatment that could be hazardous.”

That’s not to say that all production has shifted from grassroots efforts to a factory setting.

Now, in addition to coordinating its efforts with the Navy and other Army agencies, CCDC SC is making its technical data package for the first face cover available to units that have the capability to produce them, said Tamilio.

### THE NEXT BIG NEED

To say that efforts to respond to the urgent and enormous need for effective face coverings have been a learning experience is an understatement on a pandemic scale. Those involved are eager to make maximum use of the knowledge gained.

CCDC SC will establish shortly a means of sharing its designs via a controlled open source domain for state and local authorities around the country in need of a proven face cover design, giving them all the information necessary for production.

“We want to look at what do we do the next time? Maybe it’s not a pandemic, it’s something else,” Jones said. “Next time there’s an emergent need, how do we use organic capability” to solve the problem?

More specifically for 3D printing and additive manufacturing, “How do we, at the tactical level, better link into Army capability? We just try to prototype and innovate a new way from the bottom up. We aren’t a manufacturing capability.”

Whatever the scale of production—“whether we make one mask or a million masks,” Jones said—“the great part is in the doing it—to get a solution and do our part.”

*For more information on the 1st Special Forces Group (Airborne) initiative to make face covers, contact the group Public Affairs Office at 253-966-4882. For more on the CCDC Soldier Center project, contact the Public Affairs Office at 508-206-3592. For more about the long-range Army Face Cover program, call PEO Soldier Public Affairs at 703-704-4963.*

---

*MARGARET C. ROTH is an editor of Army AL&T magazine. She has more than a decade of experience in writing about the Army and more than three decades’ experience in journalism and public relations. Roth is a MG Keith L. Ware Public Affairs Award winner and a co-author of the book “Operation Just Cause: The Storming of Panama.” She holds a B.A. in Russian language and linguistics from the University of Virginia.*



### EXAMINING THE GOODS

A Soldier from the 595th Sapper Company, 5th Engineer Battalion looks at the dispenser launcher modules for terrain-shaping obstacles in the back of an M113, in support of a Soldier touch point for Product Manager TSO and PM CCS. (Photo by Marc A. Krauss, JPEO A&A)

# VIRTUAL REVIEW

A JPEO A&A team developed a novel approach to conducting a system review, to stay on schedule in the face of social distancing restrictions.

*by Stephen McFarlane and Capt. Harold “Trey” Bishop*

**I**n alignment with the Army modernization priority for enhanced mines and munitions area-denial capabilities, the Project Manager for Close Combat Systems (PM CCS) within the Joint Program Executive Office for Armaments and Ammunition (JPEO A&A) at Picatinny Arsenal, New Jersey, is developing the Wide Area Munition, XM204 Top Attack. The munition will enhance Soldiers’ ability to shape the terrain with the construction of complex obstacles.

The XM204 Top Attack project team began the planning and preparation for the “typical” face-to-face system requirements review and system functional review in late February. However, on March 12, the team was advised that all near-term and future travel was restricted owing to the coronavirus pandemic. The COVID-19 social distancing restrictions presented the project team the challenge of finding an alternative way to execute this major system engineering review, with up to 80 participants, in a remote manner using a computer-based virtual communication application—or run the risk of falling behind schedule in developing this critical capability.

**THE CHALLENGE**

The XM204 development program scheduled a system requirements review combined with a system functional review in early April 2020. The system requirements review is a formal review between the prime contractor and the government to ensure a complete and mutual understanding of system requirements. The review ensures that the XM204 Top Attack system can proceed into initial systems development and that all system and performance requirements are defined, testable, and consistent with cost, schedule, risk, technology readiness and other system constraints. The system functional review is a technical review to ensure that the system’s functional baseline is established and can satisfy the requirements within the currently allocated budget and schedule. These reviews typically occur before technologies have matured, in an effort to complete a preliminary design.

**SHAPING THE TERRAIN**

Imagine you’re in a small contingent of Soldiers—a squad or platoon element—in the field. The enemy is due north and will be approaching your location with heavy tracked vehicles. Reinforcements are a couple of days out, so you must alter the enemies’ path of travel or they will find your position and you will be overrun. You have several XM204 Top Attack munition systems at your disposal and have decided to set up an obstacle. Obstacles are a means to limit the enemy’s ability to maneuver and can be composed of ditches, wire, natural terrain restrictions and lethal munitions. In this case, you have decided to go with the lethal munitions option. The XM204 Top Attack will cause the enemy to reconsider their operational advance because of the risk or realization of costly casualties if they continue down a path of travel that will lead them directly to your location.

After hand emplacement of the obstacles, you hightail it far outside the munitions’ effective range while leaving reconnaissance elements to maintain watch over the obstacles. Several hours later, your overwatch element confirms that multiple XM204 Top Attack munition systems launched submunitions that effectively engaged enemy vehicles, causing extensive damage and resulting in the enemy having to change directions. Mission accomplished. The emplaced obstacle effectively shaped the terrain, resulting in enemy maneuver in a direction that gives your Soldiers sufficient time for reinforcements to arrive.



**FRONT-ROW SEATS**

Capt. Harold “Trey” Bishop, assistant product manager for (TSO) and co-author, monitors the virtual system requirements review and system functional review in April. TSO utilized available technology to quickly convert the exhaustive three-day, in-person review to an online event. (Photo courtesy of the author and JPEO A&A)

**THE SOLUTION**

The project team conducted an expedient analysis of alternatives to evaluate the best virtual tool to effectively enable contractor-to-government presentation of materials and joint collaboration. The team ultimately selected the Federal Risk and Authorization Management Program (FedRAMP)-approved version of WebEx. However, this didn’t solve the problem of ensuring that everyone received and understood all the briefing materials in support of the review. The team developed a novel approach to conducting a virtual conference whereby panel members could count on receiving timely information sufficient to conduct full assessments of the system requirements review and system functional review entrance and exit criteria. In advance of the event, the team supplied:

- Briefing packages with embedded audio narration.
- Questions solicited from review panel members pertaining to the briefing packages, with responses.
- Training sessions with FedRAMP-approved version of WebEx.
- Customized templates to capture, organize and disseminate questions and answers from the entire team before the conference.



These four keys were of the utmost importance in conducting a virtual meeting of this size and importance. The delivery of audio-enhanced briefings, audio added via a built-in Microsoft PowerPoint feature, before the event provided sufficient narrative detail to enable a cursory review of the information during the actual review. The pre-event capture and response to panel members' questions reduced the amount of time that would be required for questions and answers during the event. The pre-event training and familiarization events with the WebEx virtual tool enabled a majority of the team to hit the ground running, with all participants fully operational within the first half-hour of the first day. The customized templates for questions and answers enhanced the delivery of multifield, sortable information to enhance panel members' understanding of the material presented.

In addition, the project team developed and distributed event rules of engagement



#### LOAD 'EM UP

Soldiers from the 595th Sapper Company load TSO dispenser launcher modules onto a Palletized Load System truck. (Photo by Marc A. Krauss, JPEO A&A)

**Social distancing restrictions presented the project team the challenge of finding an alternative way to execute this major system engineering review, or run the risk of falling behind schedule.**

to ensure orderly communication and sharing of information. The rules specified that microphones be muted as a default and instructed participants not to place calls on hold because of built-in hold music that is a distraction to others on the line. They also noted how presentations would be delivered, how the host would manage the information that must be shared with the team, how team members would use the chat function, and contingency communications for those unable to access the web-based application to view briefing information.

The XM204 integrated product team implemented an ambitious plan to complete the planned face-to-face, three-day review in a 1½-day virtual review. The execution of this meeting required three

primary roles: a knowledgeable host to facilitate the discussion, an assistant host who managed screen share with attendees and a note taker.

The first day of the review began with a 30-minute sign-in session to ensure that team members were able to access WebEx via web browser (preferred) or solely by telephone audio (not preferred). The team achieved 100 percent sign-in with time to spare before moving on to the briefing packages.

For each briefing package, the host announced the slide deck and the briefer. The briefer provided a five-minute executive summary of the material covered. Then the briefer answered questions from the review panel members and program

leaders. Subsequently the reviewed actions were captured and the process was repeated for all other briefs. This format enabled the review of 17 briefing packages between 8:30 a.m. and 4 p.m. on the first day.

The second day's activities included a panel member breakout session to assess the XM204 program in accordance with the system requirements review and system functional review entrance and exit criteria, as well as a separate system requirement document review. The panel breakout session balanced multiple perspectives and information, with representation from industry, the U.S. Army Combat Capabilities Development Command, the PM CCS project management office and JPEO A&A. The separate program team review of the requirements document ensured understanding of the system requirements at the lowest level of detail.

Following the review and breakout session, the panel chair briefed the program team on the panel's assessment of the system requirements review and system functional review entrance criteria and exit criteria. The assessment included a detailed synopsis of whether the criteria were met, partially met or not met. The end result?

The panel provided concurrence on successful completion of the system requirements review and system functional review. The success of this key program activity is largely attributable to the team's preparation. "Your preparation and upfront attention to detail worked to make the system requirements review and system functional review a success," said Joe Pelino, acting project manager for Close Combat Systems, to the team. The XM204 project team captured pre-event preparation tasks and post-event lessons



### PROTOTYPE TEST DRIVE

Soldiers from the 595th Sapper Company participate in the evaluation of two terrain-shaping obstacle prototypes July 24-25, 2019, at Fort Leonard Wood, Missouri. JPEO A&A is working to develop this capability through its Close Combat Support program. (Photo by Marc A. Krauss, JPEO A&A)



### AT EASE

Soldiers from the 595th Sapper Company sit beside terrain-shaping obstacle dispenser launcher modules in the back of an M113 in support of the Soldier touch point event for PM CCS/Product Manager TSO. (Photo by Marc A. Krauss, JPEO A&A)



### AWAITING TESTING

Palletized terrain-shaping obstacles dispenser launcher modules on a Palletized Load System truck before a road test. (Photo by Marc A. Krauss, JPEO A&A)

learned into a single briefing package that was disseminated throughout JPEO A&A.

### CONCLUSION

The XM204 project team successfully completed the key system engineering reviews, system requirements review and system functional review in the midst of COVID-19 related challenges. Ken Heider, acting product manager for Terrain Shaping Obstacles, stated, “I was very pleasantly surprised with how well we were able to execute the review under the current circumstances.” The XM204 development contractor is now well positioned to proceed to preliminary design completion.

The next major scheduled review is the preliminary design review. The system requirements review and system functional review events set the foundation for the rest of the development and the success of the program.

*For more information, contact Stephen McFarlane at [stephen.r.mcfarlane.civ@mail.mil](mailto:stephen.r.mcfarlane.civ@mail.mil) or Capt. Trey Bishop at [harold.j.bishop6.mil@mail.mil](mailto:harold.j.bishop6.mil@mail.mil).*

---

*STEPHEN MCFARLANE is a project officer for Terrain Shaping Obstacles within the Close Combat Systems Project Office at JPEO A&A. McFarlane holds an M.S. in mechanical engineering from Stevens Institute of Technology and a B.S. in mechanical engineering from Lafayette College.*

*CAPT. HAROLD “TREY” BISHOP is assistant product manager for Terrain Shaping Obstacles within the Close Combat Systems Project Office at JPEO A&A. He holds a BBA in finance from Texas A&M University*



### SOLUTION WANTED

Rodriguez Live Fire Complex is a 3,900-acre training area in South Korea. Because of space constraints, errant training rounds are a recurring problem. FAST advisers offered 8th Army a solution that also matured relevant technologies. (Photo by the author)

# FIELDING *THE* PROTOTYPE

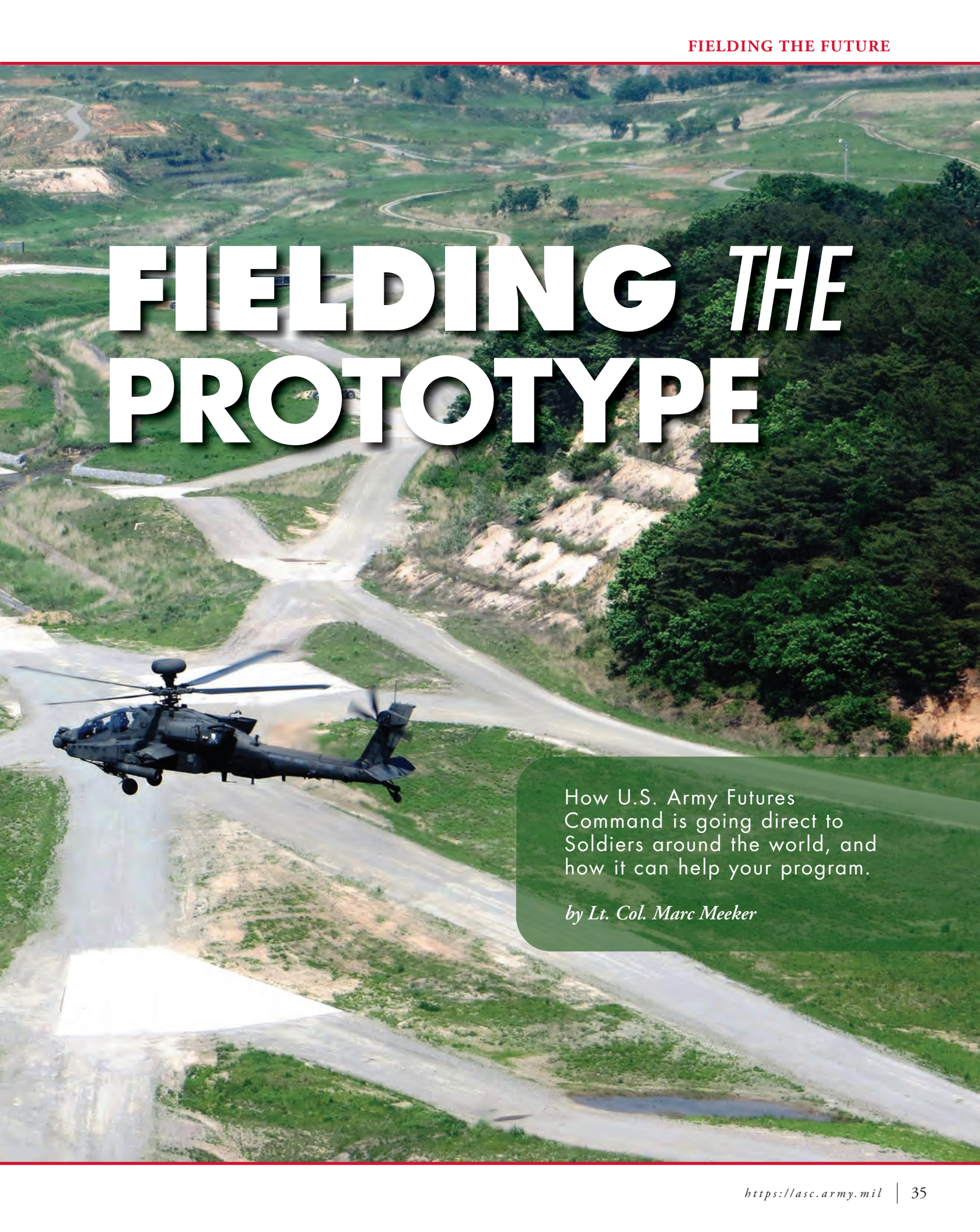
An aerial photograph of a black Army helicopter in flight over a landscape. The helicopter is positioned in the lower-left quadrant of the frame, flying towards the right. The landscape below features a network of roads, green fields, and some rocky terrain. The overall scene is captured from a high angle, providing a clear view of the terrain and the helicopter's path.

How U.S. Army Futures Command is going direct to Soldiers around the world, and how it can help your program.

*by Lt. Col. Marc Meeker*

**I**t happens in nearly every Hollywood action movie: “This is only the prototype. It will outgun [insert bad guy name], but it still has some bugs to work out.”

The movie’s hero inevitably takes the prototype system and uses the new(er) technology to defeat the enemy. Is this just Hollywood fiction, or does the U.S. Army have similar programs that put the newest technology into the hands of Soldiers in the field?

It does. In addition to its nine international technology centers, the U.S. Army Combat Capabilities Development Command (CCDC) has seven Field Assistance in Science and Technology (FAST) teams worldwide, managed by CCDC’s Global Technology Office. With standing positions on the general staffs of U.S. Army Europe and U.S. Forces Korea (among others), these teams offer uniquely direct feedback from Soldiers in the field on developmental systems and technology. The Soldiers and defense acquisition civilians who make up the FAST teams have a two-way mission: Get technology to the field faster, and apprise the Army’s scientists, engineers and requirements writers on what the field commands need.

FAST taps directly into the acquisition cycle, essentially expediting the relationship between the warfighter and the materiel developer while supporting the requirements development process. The result is that program managers can put their newest technology into the hands of Soldiers for developmental feedback, or, optimally, provide insight into emerging requirements even before they reach the U.S. Army Training and Doctrine Command’s (TRADOC) centers of excellence, where many program offices have embedded staff members.

Program offices and CCDC engineers have leveraged FAST effectively. The teams that were most successful learned through experience to follow these four guidelines

**FAST is a critical tool in ensuring relevance and effective development of systems for the Army’s future.**

to get the most out of the opportunity to put technology directly into the hands of Soldiers:

- Have a plan.
- Build consensus.
- Be a part of the bigger picture.
- State the costs and benefits up front.

The following real-life examples illustrate each of these four lessons.

**PLAN TO MEET THE NEED: ENHANCED CAMERA**

When CCDC chemical and biological engineers approached the FAST team at U.S. Forces Korea (USFK) in April 2016, they were already working with the Joint Program Executive Office for Chemical, Biological, Radiological and Nuclear Defense (JPEO-CBRND) to develop low-cost alternatives to existing stand-off detection systems. CCDC’s Chemical Biological Center knew about the persistent threat of nonconventional weapons

from North Korea, and standoff detection systems were of great interest to USFK.

What the engineers needed was an operational test to move their work toward transition and integration under JPEO-CBRND’s portfolio. Threat imaging dual-use aerosol monitoring alarms/security represented a low-cost, multicomponent camera that provided infrared and thermal detection. While these capabilities are not new on the battlefield, the subcomponents and algorithms built into the camera system gave it a superpower: the ability to detect chemical agents at a distance.

After developing three prototype systems, the next step was to test the threat-imaging technology in a realistic environment that would challenge its capabilities. Coincidentally, the USFK FAST Office had just received a call from the United Nations multinational battalion at the Demilitarized Zone, seeking assistance in repairing their aging camera system, which was used to provide U.S. and South Korean troops with situational awareness on one of the most fortified borders in the world.

The threat-imaging system would fill this niche requirement perfectly, providing U.S. Soldiers on the front lines with enhanced cameras while allowing a team of engineers to gather valuable data on the system’s operation in a field environment, with complications such as extreme weather, Asia’s famed “yellow dust” and even enemy spoofing attempts. The FAST team took the reins and sought concurrence from USFK’s J-3 (operations), J-8 (budget, requirements, analysis and modernization) and legal offices, as well as the U.N.’s Command Military Armistice Commission. The commission, established in July 1953 at the conclusion of



### MINIMAL THREAT

Maxwell Bottiger and Fiona Narayanan, engineers from the CCDC Chemical Biological Center who work on threat imaging dual-use aerosol monitoring systems, consult with their escort from the U.N. Military Armistice Commission. The system has the ability to detect chemical agents at a distance. (Photo by the author)

the Korean War, supervises the implementation of the Korean armistice agreement and serves as the higher headquarters of the security battalion at the Demilitarized Zone.

Navigating this maze of staff offices to install three cameras at the Demilitarized Zone was nearly as challenging as developing the camera system's detection algorithms. As part of the USFK

staff, the FAST team had an optimal view of the path forward and could see the immediate need that had yet to be formalized in requirements circles. Within six months of initiation, the cameras were overlooking the fields of North Korea from a high perch along the Demilitarized Zone, providing U.S. Soldiers with enhanced security.

As with the camera system, FAST advisers actively seek out program management offices, research and engineering centers and even industry to meet established and emerging needs for U.S. Soldiers around the world. No other part of the institutional Army has such a complete network of acquisition-certified, technically capable personnel in place. This network has the potential to deliver prototype technologies that can solve warfighter challenges or have a direct, positive impact on a command's mission capabilities.

### **BUILD CONSENSUS: COMMUNICATIONS WITH LIGHT**

The U.S. Army Europe (USAREUR) area of operations has evolved into a rapidly changing and potentially contested environment. In his book "The New Rules of War," Sean McFate describes countries such as Russia that are "playing by new rules that we have not yet recognized." McFate asserts that U.S. adversaries take advantage of a tendency of our government to see war as "binary"—either we're at war or we're not—by operating below that threshold.

USAREUR has identified multiple ways that adversaries stay beneath that threshold, including interruption of communications

**FAST advisers actively seek out program management offices, research and engineering centers and even industry to meet established and emerging needs for U.S. Soldiers around the world. No other part of the institutional Army has such a complete network of acquisition-certified, technically capable personnel in place.**

### **CUAS EFFORTS HAVE DEEP ROOTS**

CCDC's international engagement efforts are twofold: International technology centers bring the best of what international industry has to offer, and FAST teams get "shovel-ready" technology out of the labs and into the hands of Soldiers.

CCDC's counter-unmanned aerial systems (CUAS) efforts have crossed both offices, starting back in 2013. In conjunction with the deputy assistant secretary of the Army for defense exports and cooperation, the CCDC International Technology Center for South Korea established a project agreement on co-development of C-UAS technologies. This agreement meant that both the U.S. and South Korean defense researchers would put money and expertise on the table for a collaborative effort to develop CUAS technologies that were capable, producible and interoperable.

Fast-forward to 2016, when the 8th Army needed assistance solving its "errant round" problem at Rodriguez Live Fire Complex, South Korea. There, FAST connected the dots to provide a venue for field testing of the radar component of the C-UAS project agreement, simultaneously putting a component promised to the South Korean Agency for Defense Development for characterization and integration.

The DOD Coalition Warfare Program liked the CUAS project agreement enough to award funding in 2016, which has been further extended through 2020, allowing additional maturation.

through electronic signals disruption. This topic arose during USAREUR leadership engagements in 2017 and 2018, leading the USAREUR G-6 (networks, communication and information security) to initiate a search for improved communications technologies that would help resolve this emerging challenge.

In 2018, the CCDC FAST team at USAREUR queried the command's Army Research Laboratory and C5ISR Center and returned to USAREUR with details on developmental light fidelity (Li-Fi) infrared wireless communications technology, capable of sending 600-plus megabits per second in inclement weather, with no residual radio frequency signature. The USAREUR G-6 had heard about this new technology and, working hand in hand with



FAST, helped tie in the G-2 (intelligence), G-3 (operations) and other key players, such as the Army Cyber Command liaison, Rapid Equipping Force, USAREUR's liaisons to TRADOC and the Office of the Assistant Secretary of the Army for Acquisition, Logistics and Technology, and experts from multiple research and development centers within CCDC.

All concurred that this technology had tremendous potential to help USAREUR with emerging requirements. During a windy, rainy week in fall 2019, the FAST team, in conjunction with USAREUR G-6 technical advisors, Soldiers, Army Research Laboratory scientists and C5ISR engineers and contractors, conducted sustained and effective data transfer for a team of visiting leaders that included Lt. Gen. Christopher Cavoli, USAREUR commanding general. By building consensus within USAREUR and with the right points of contact, the FAST team successfully demonstrated a technology that met the emerging needs of the USAREUR command, paving the way for further development of Li-Fi technologies.

### **BE PART OF THE BIGGER EFFORT: DEVELOPMENTAL ROBOTICS**

The Army has focused doctrine and technology development on multidomain operations, which includes fighting across land, sea, air and cyber. Under the land portion, combatant commands have further emphasized the need for a renewed focus on the megacity challenge, as well as subterranean operations. To this end, CCDC's Armaments Center established a community of interest to bring requirements writers, materiel developers, scientists, engineers and Army commands together. The Defense Advanced Projects Research Agency (DARPA) has even come to the table with its Subterranean (SubT)



### **ROBOT OF ALL TRADES**

Tunnel reconnaissance robots like this one, co-developed with DARPA, the CCDC Ground Vehicle Systems Center and South Korea to meet the requirements of the 2 ID, are part of an effort aimed at integrating autonomous mapping, data teaming, and chemical, biological, radiological and nuclear sensor capabilities to support subterranean operations. (Photo courtesy of Lt. Col. Michael Sansone, CCDC – Pacific)

Challenge. The FAST teams at USAREUR and USFK joined this SubT community in 2015, leveraging it to bring relevant expertise and technology to Soldiers.

The first big victory for this effort was in South Korea, with the Rapid Equipping Force under the Program Executive Office for Soldier procuring specially modified iRobot platforms for subterranean operations. These robots had been developed over more than 10 years in a

collaborative effort between DARPA and CCDC's Ground Vehicle Systems Center (formerly the Tank Automotive Research, Development and Engineering Center), and answered an operational needs statement for the 2nd Infantry Division (2 ID).

Although the first iRobot platforms didn't transition to a program of record, they paved the way for later developmental programs informed by the work of the SubT community of interest and emerging



**NO-RESIDUE SIGNAL**

This antenna, used during a wind- and rain-filled demonstration in fall 2019, is capable of sending 600-plus megabits per second in inclement weather, with no residual radio frequency signature. (Photo courtesy of Maj. Bryan Riddle, FAST USAREUR)

requirements from 2 ID. Most recently, CCDC FAST at USFK has supported the Coalition Warfare Project Autonomous Tunnel Exploitation, a three-year collaborative effort among the Defense Threat Reduction Agency, CCDC Ground

Vehicle Systems Center and South Korea’s Agency for Defense Development.

The tunnel project leverages DOD research and development dollars, along with the technological capabilities of

**TIMING CAN BE EVERYTHING**

Inserting a technology into a command’s exercise cycle, often in an overseas command, needs to be sniper-like in its precision. Program offices have failed by overlooking international treaty requirements on exportable technologies or (among other things) electromagnetic spectrum concerns put forth by foreign governments.

Worse, materiel developers have come to commands with last-minute requests to put a prototype system into a multinational tactical exercise (e.g., Defender 2020) that has been intricately planned for months or even years. An Army staff in the spin-up to such a major exercise is already working overtime to execute mission requirements; the prospect of changing in-depth plans or standard operating procedures and swapping out trusted equipment for an unproven prototype is absolutely untenable—unless it was planned in advance.

Enter the FAST office, under CCDC’s G-3, with its experimentation master plan, which lays out named exercises in the coming years, while aligning potential technology insertions with command requirements. CCDC builds the exercise management plan with input from its FAST officers around the world, who have access to exercise calendars, integrated priority lists and general staffs, where they sit daily to learn about a commander’s biggest challenges.

FIGURE 1

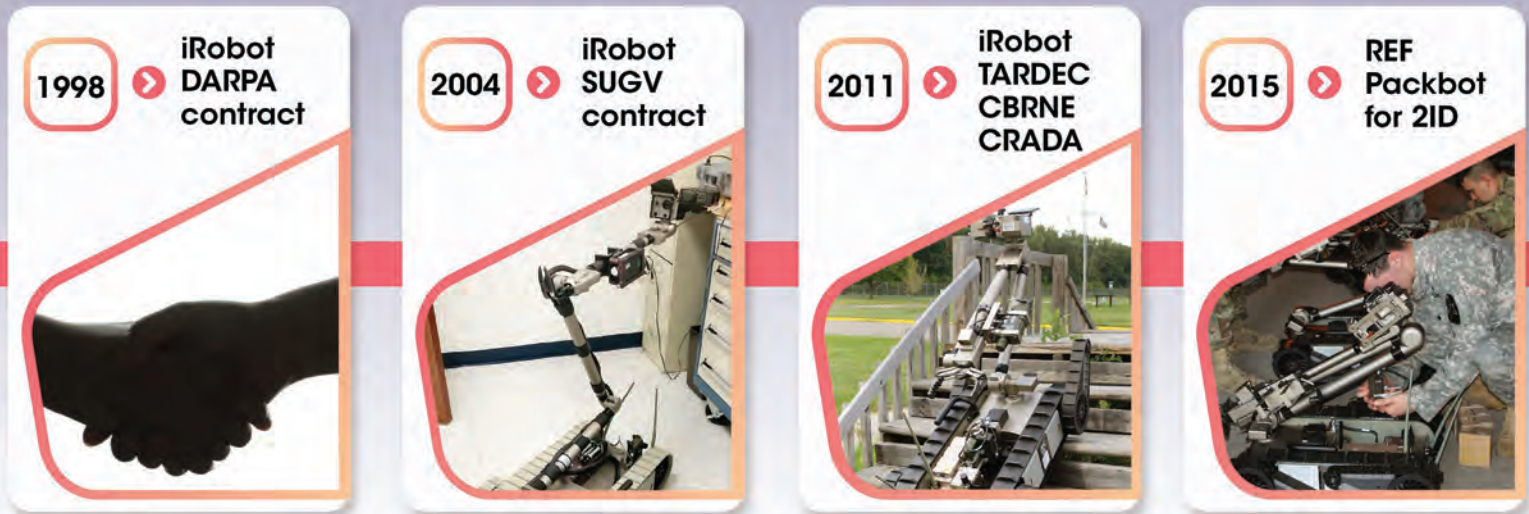

## KEY

**CBRNE:** Chemical, biological, radiological, nuclear and explosive

**CRADA:** Cooperative research and development agreement

**DARPA:** Defense Advanced Research Projects Agency

**2ID:** 2nd Infantry Division

**REF:** Rapid Equipping Force

**SUGV:** Small unmanned ground vehicle

**TARDEC:** U.S. Army Tank Automotive Research, Development and Engineering Center

## YEARS IN THE MAKING

Specialized robots, developed over more than 10 years in a collaborative effort between DARPA and the CCDC Ground Vehicle Systems Center, answered an operational needs statement for the 2 ID. (Image by the author)

our foreign partners, to meet U.S. Army acquisition goals. In line with the challenges facing the 2 ID, the project aims to integrate autonomous mapping, data teaming, and chemical, biological, radiological and nuclear sensor capabilities to support subterranean operations and address the capability gap for rapidly characterizing and exploiting underground facilities. Further, by tying back to the SubT community of interest and relevant CCDC research and development centers, FAST Korea serves as the bridge between technology development and the emerging requirements of the commanders at 8th Army, 2nd Infantry Division

and Joint United States Military Affairs Group – Korea.

**STATE THE COSTS UP FRONT: CUAS SUBTECHNOLOGIES**

Drones are a force to be reckoned with on present and future battlefields, as evidenced by the recent strike against Iran's Gen. Qassem Soleimani. U.S. Army commands around the world have been asking aggressively for counter-unmanned aerial system (CUAS) capabilities.

While many options are in development, no clear leader exists. This is partially because the underpinning technologies for CUAS are in constant evolution. If

commanders are made aware of the limitations up front, FAST officers can bring pieces of developmental materiel forward to solve present-day problems, while answering the need for researchers and program offices to conduct operational and limited user testing. This happened in 2016 when 8th Army's commanding general, Lt. Gen. Thomas Vandal, had to stop live-fire training at the Rodriguez Live Fire Complex for the entire South Korean peninsula because training rounds landed outside of designated impact areas. In conjunction with CCDC's Armaments Center, the command's FAST team at USFK offered a potential solution: As part of a developmental CUAS system, the Armaments

FIGURE 2



**KEY**

**RDECs:** Research and development centers  
**ITCs:** International technology centers  
**DEAs:** Data exchange annexes  
**PAs:** Project agreements

**ESEP:** Engineer and Scientist Exchange Program  
**COTS:** Commercial off-the-shelf  
**FAST:** Field Assistance in Science and Technology  
**COCOM:** Combatant command

**DARPA:** Defense Advanced Research Projects Agency  
**DTRA:** Defense Threat Reduction Agency  
**REF:** Rapid equipping force  
**PEO:** Program executive office

**COLLABORATION MATRIX**

International technology centers, the CCDC and FAST work together to provide technologies to the program manager. (Image by U.S. Army Acquisition Support Center; SOURCE: the author)

Center sought a venue to test the counter rocket and mortar radar in a live-fire environment.

Up front, the costs to the 8th Army command would be a piece of terrain on Rodriguez Range, 24-hour security for

the radar system and assistance with the appropriate approvals to have it shipped to South Korea. As a caveat, FAST advisers warned that 8th Army might have to pay for or facilitate shipment of the radar to South Korea. The payoff for the Armaments Center researchers was twofold.

First, Rodriguez Range conducted combined-fires exercises that would see a variety of rounds crossing the radar's tracking system, which would provide unique data on its ability to "see" UAS through battlefield clutter. In addition, the radar would eventually need to be moved

to South Korea as part of a bilateral CUAS developmental agreement. Testing it at the range would solve both problems, as well as provide 8th Army with a way of seeing exactly where training rounds were going. With this knowledge, range procedures and terrain could be examined to (potentially) preclude future out-of-impact-area incidents. The 8th Army commanding general and staff saw this as a solid win, as all they needed to provide was, in essence, paperwork.

The emplacement of the counter-rocket and mortar radar at the Rodriguez Live Fire Complex was just one smart, multi-purpose step in a chain of events that are still playing out today. The CUAS also received more than \$1 million in DOD Coalition Warfare Program funding, which was extended in 2019. CCDC's Armaments Center has collaborated with the Project Director for Counter-Rocket, Artillery and Mortar, under the Program Executive Office for Missiles and Space, to mature the effort toward transition, while actively developing subtechnologies with the South Korean Ministry of Defense's research arm, the Agency for Defense Development. This effort likely would have stopped back in 2016 if 8th Army hadn't been informed of the costs up front, allowing it to conduct a well-informed cost-benefit analysis.

## CONCLUSION

Program managers and the CCDC researchers who feed the materiel development pipeline are constantly seeking details on what the warfighter wants, while at the same time trying to mature the technologies in their portfolios. CCDC's FAST teams are ideally positioned to help achieve these goals simultaneously, while providing real-world feedback from the Soldiers within combatant commands and Army service component commands.

By approaching FAST with capable technologies that meet warfighter needs, a program manager can expect assistance in building momentum and consensus toward established goals, from clarifying requirements through maturing technologies, and onward toward low-rate initial production. By tying into greater efforts such as the big six modernization priorities (and subtechnologies), program managers can ensure relevance and assured interest from the commands, facilitated by FAST officers who will regularly assist with communication between the program manager and the respective command. Finally, to garner command sponsorship, it is critical to state the costs up front for an accurate cost-benefit analysis; if, after that analysis, the answer is "no," then a direction has been chosen, and informed adjustments can be made.

The network of FAST advisers is already established worldwide. Through purposeful planning via CCDC's Exercise Management Plan, key technologies are being aligned to insert in named exercises and in accordance with established and emerging warfighter requirements. FAST is a critical tool in ensuring relevance and effective development of systems for the Army's future.

*For more information, go to the CCDC webpage at <https://www.army.mil/ccdc#org-resources>.*

---

*LT. COL. MARC MEEKER is the director of the International Technology Center – Northern Europe, with offices at Frankfurt Consulate and Koblenz, where he is co-located with the German Ministry of Defense's acquisition arm. He most recently wrote for Army AL&T about the international technology centers' mission worldwide ("International Innovation," Winter 2020 issue, Page 54). He holds an MBA with an acquisition focus from the Naval Postgraduate School and an undergraduate degree in mechanical engineering and design technology from Oklahoma State University. He is Level III certified in program management and an Army Acquisition Corps member. He speaks fluent German, conversational Spanish and passable Japanese.*

**By building consensus within USAREUR and with the right points of contact, the FAST team successfully demonstrated a technology that met the emerging needs of the USAREUR command, paving the way for further development of Li-Fi technologies.**

# EMBRACING DIGITAL ENGINEERING

JPEO-CBRND uses new acquisition approaches to keep pace with modernization.

*by Gail Cayce-Adams and Kevin Joubert*

As defense programs continue to integrate more and more advanced technologies, program managers are faced with the challenge of how best to manage these increasingly complex systems. To add to the chaos, many of today's military programs integrate with other systems, requiring collaboration among groups of stakeholders that may have differing priorities. It is no longer possible to manage a program in a vacuum as a solitary effort. How each capability interfaces with and affects other capabilities on the battlefield must be considered early and often throughout a program's life cycle.

To aid in managing the complexities of the acquisition process and the unique challenges involved in meeting the chemical, biological, radiological and nuclear (CBRN) defense needs of all U.S. military services, the Joint Program Executive Office for Chemical, Biological, Radiological and Nuclear Defense (JPEO-CBRND) is embracing the shift toward a digital engineering environment. One of the first JPEO-CBRND initiatives to enable this shift in how to do business was the creation of an analytical framework—a process that uses a combination of data, analysis methods and software tools to better manage its portfolio of products. As much as possible, the analytical framework replaces subjective and qualitative judgments with objective and quantitative analysis. The analytical framework team is tasked with providing analytical support to the joint project managers (JPMs) that fall under the JPEO-CBRND umbrella.

JPM CBRN Sensors develops, fields and sustains CBRN sensors, reconnaissance systems, mobile laboratory systems and obscuration capabilities for the Army. In 2018, JPM CBRN Sensors launched an effort to enhance the sensor suite package on the primary vehicle used by CBRN forces, known as the Nuclear, Biological and Chemical Reconnaissance Vehicle (NBCRV). A phased modernization approach is being used to deliver new capabilities in increments known as capability sets, enabling faster delivery to the field. The upgraded sensor suite package will leverage

### CONTAMINANT FREE ZONE

The NBCRV's upgraded sensor suite package will use the manned-unmanned teaming concept to allow detection of CBRN threats at a distance using unmanned air and ground vehicles, reducing the risk to warfighters by keeping them out of the contaminant. (Photo by Jack Bunja, U.S. Army Combat Capabilities Development Command)



unmanned air and ground vehicles using the manned-unmanned teaming concept to allow detection of CBRN threats at a distance, reducing the risk to warfighters by keeping them out of the contaminant.

Manned-unmanned teaming is a new approach for the NBCRV sensor suite upgrade (SSU) program. They needed a means to quickly assess how these capabilities, along with other sensor suite enhancements, change the operational effectiveness of the NBCRV. The program was also looking for a way to gain insights into the impact of the new NBCRV SSU capabilities on the larger maneuver force, since this is difficult to determine through testing. The NBCRV SSU program reached out to the analytical framework team for help.

### WHAT'S THE MISSION IMPACT?

The analytical framework team modeled five battalion-level scenarios representing the primary mission spaces for the NBCRV: offense; defense; tactical road march; movement to contact; and reception, staging, onward movement and integration. The scenarios are run in the combat simulation, One Semi-Automated Forces (OneSAF), to help understand the effects of new NBCRV SSU capabilities within the different mission spaces and to explore employment options for the unmanned systems. OneSAF models real-world representations of platforms, Soldiers, equipment, logistical supplies, communications systems and networks, emerging threats, and aviation assets to

achieve the level of fidelity required for a particular application or scenario.

Videos of the scenarios running within OneSAF were used to support the Mounted CBRN Reconnaissance and Surveillance Table Top Exercise held at the Maneuver Support Center of Excellence at Fort Leonard Wood, Missouri, in November 2019. The videos were used as conversation starters before the table top exercise discussions. This has proven to be an effective way for participants to visualize how operations are likely to play out and has served as an added benefit derived from the modeling efforts. Insights gleaned from the table top exercise, as well as future coordination among the analytical framework team and the Maneuver and Maneuver Support Centers of Excellence

FIGURE 1

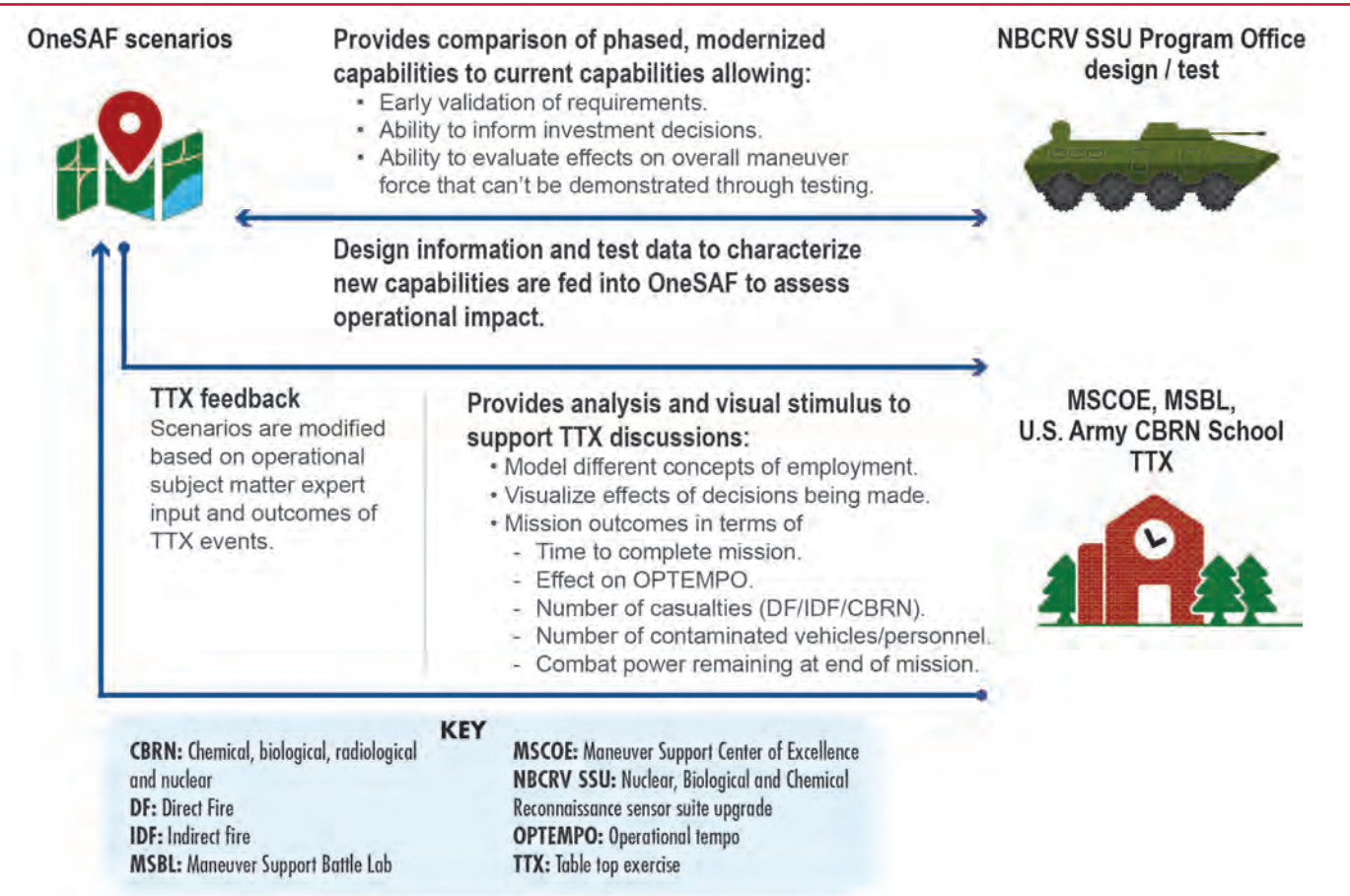

**COMBAT SIMULATOR**

Scenarios are run in OneSAF to help understand the effects of new NBCRV SSU capabilities within the different mission spaces and to explore employment options for the unmanned systems. (Image by Gail Cayce-Adams, JPEO-CBRND)

and the U.S. Army CBRN School, will be used to ensure the operational accuracy of the scenarios. Upon completion of this effort, the scenarios will be used to perform in-depth analysis for the NBCRV SSU program as each new capability set is developed.

**NEW APPROACHES**

In an effort to develop a repeatable, data-driven approach to examining the trade-off between performance factors (e.g. speed versus power) the analytical framework team has recently expanded its use of decision support tools and engineering-level value models. These tools are used to select the most viable solutions from the pool of candidate systems during different phases of the acquisition life cycle, enabling a reduction in both cost and operational risk. The analytical framework team has combined objective

performance traits, modeled performance and program metrics, such as cost and schedule, into utility models. The combination of these models, along with face-to-face stakeholder sensitivity analyses, has led to increased consensus and confidence in system selections.

Use of the trade-off methods outlined above has paid dividends, but the team is looking to understand not just system-level trades but higher-level ones as well. Currently the trade-offs would be between system performance metrics, like speed or weight. For instance, faster and lighter may be better, but you can't be both fast and light. However, the next step is to move from system performance level to combat-effectiveness level. Does a faster system really increase survivability in combat? Or does the weight



of a system have a larger effect on survivability in combat, perhaps? Currently, experts provide input on the importance of things such as speed and weight to the utility of a system. In the near future, we will use expert opinion less and the results from combat models more.

Rather than looking at what improvements to a particular system to buy, it is now possible to use OneSAF to consider whether improvements in one functional area, such as detection, provide more benefit than improvements in another functional area, such as protection. For instance, is it preferable to have CBRN suits with better thermal comfort or to have a detector with faster response time?

The NBCRV will be the first JPEO-CBRND system to use OneSAF to examine these types of cross-commodity trades.

### FUTURE WORK

With the success achieved so far with the creation of the analytical framework, JPEO-CBRND is taking additional steps to fully embrace the shift toward a digital engineering environment through improved data management techniques and more reliance on models and simulation.

Previously, CBRN data lived in disparate, isolated sources that were not readily available to those who may have needed

**In the near future, we will use expert opinion less and the results from combat models more.**

it. This led to duplication of effort to produce needed data or use of data that was not necessarily the latest and best to support decision-making. To correct this, JPEO-CBRND has initiated an effort to create a centralized CBRN data repository to ensure everyone has access to the same validated data sets and to make sure knowledge is preserved.

The repository will hold all data pertaining to CBRN capabilities, including programmatic data such as cost, schedule and performance as well as modeling and simulation inputs and outputs, test data and any other data generated over the course of a program's life cycle. Sources for the data will be listed, as well as a point of contact who can be reached for more information. That point of contact will have the responsibility for making sure the data is up to date. Storing data in a centralized repository will allow it to be updated one time and then made available to all, reducing errors and ensuring that the same, consistent data is being used at all times. As we adopt more digital engineering principles, we hope to develop the digital thread that will connect all phases of the program's life cycle, so that when data is updated, it will automatically disseminate out to each place it is being used, such as component-level models, engineering drawings, inputs for combat models and test plans. As a simple example, if the name of a system component were to change, the ideal process would be that the point of contact for that component would log into the centralized data repository and update the name, which would then be automatically updated everywhere else that the component name is used.

JPEO-CBRND is also embracing the use of models and simulations at each stage of the program life cycle, from item-level engineering models that inform system

designs, to trade-space models that examine ways to reduce cost and improve performance, to combat simulations that demonstrate the mission impact of new capabilities.

### CONCLUSION

The JPEO-CBRND end goal is to put into place the architecture and necessary processes to create a digital environment that will remove the manual processes in existence today in favor of automated ones, creating a continuum across all phases of a program's life cycle, from concept to disposal. This will help create a more efficient acquisition process by reducing manual work, ensuring an audit trail throughout a program's life cycle and creating a shared understanding among all program stakeholders of the issues impacting their programs.

*For more information, contact Lori Remeto, director of analytical framework for JPEO-CBRND, at [lori.c.remeto.civ@mail.mil](mailto:lori.c.remeto.civ@mail.mil).*

---

*GAIL CAYCE-ADAMS is an operations research analyst and serves as the lead for combat analytics for the JPEO-CBRND analytical framework team. She holds an M.S. in systems management and operations research from the Florida Institute of Technology and a B.S. in computer science from the University of Maryland, Baltimore County. She is Level III certified in engineering and Level I certified in program management.*

*KEVIN JOUBERT has worked in every part of the acquisition life cycle during his 20 years of government experience in the chemical and biological protection area. He is a Level III certified engineer, with a B.S. in chemical engineering from McNeese State University and a B.S. in biology from the University of Louisiana at Lafayette.*

# RAPID ROBOTIC REQUIREMENTS RELAY

Many offices from across the Detroit Arsenal raced to develop requirements and gather information for the light- and medium-robotic combat vehicle concepts' transition to reality.

*by Corey Richards and Maj. Cory Wallace*

**A**s the Army drives toward its goal of modernizing the nation's ground combat force, it must strike a balance between defining achievable near-term objectives and defining aggressive stretch goals for future increments. It is imperative that the Army, at all levels, leverage the vast expertise within DOD to define reasonable near-term goals, while at the same time defining the objectives that lie beyond that which current technology can achieve.

Inherent to both lines of effort is a simple yet often overlooked principle: teamwork. That's how the Next Generation Combat Vehicle Cross-Functional Team (NGCV-CFT) worked with agencies both on Detroit Arsenal, Michigan, and across DOD to transition the light- and medium-robotic combat vehicle concepts into modified off-the-shelf surrogates in fewer than 18 months. While our approach was certainly not perfect, future permutations could share certain foundational principles; namely, building a talented team with people from different agencies to develop solutions for a capability gap as quickly as possible.

In simple terms, our approach communicated requirements—derived through aggressive teamwork across many organizations—clearly and frequently to industry. Bound by a common vision and purpose, our team enabled the contracting command to craft proposal requests, negotiate terms, execute procurement instruments and enter agreements with two different firms (Textron, with major partner Howe and Howe Technologies Inc.; and QinetiQ North America, with major partner Pratt Miller Defense), which are both on pace to deliver platforms with technological maturity we did not expect to see until 2023.

Many residents of the Detroit Arsenal joined the NGCV-CFT in their project: the Program Executive Office (PEO) for Ground Combat Systems, the PEO for Combat Support and Combat Service Support, Army Contracting Command – Detroit Arsenal and the U.S. Army Combat Capabilities Development Command Ground Vehicle Systems Center. The transition of Light and Medium Robotic Combat Vehicle concepts into their surrogates was not a sprint—it was a relay, one in which each participating office would lead with their expertise as needed.

## **PUT ME IN, COACH**

Given the developmental nature of both robotic combat vehicle variants, the Ground Vehicle Systems Center acted as the relay team's coach, devising the general strategy and directing when the baton transitioned to a different runner.

The first athlete out of the starting blocks was the requirement owner—in this case, the NGCV-CFT, which began an aggressive assessment of existing mature technologies relevant for the vehicle variants by meeting with different industry vendors. The team met with both well-known vendors, who routinely manage multibillion-dollar defense contracts, as well as small startups from Silicon Valley. Eventually, the number of meetings outpaced the team's ability to travel to them, and they developed an initiative called Modernization in the Motor City, which invited technology companies from across the world to travel to Detroit Arsenal and pitch their solutions to the government.

These efforts to engage with industry helped the NGCV-CFT understand what industry could deliver if the government asked



### CARRYING THE BATON

The Ripsaw M5 is a robotic combat vehicle (RCV) developed by Textron Systems and Howe & Howe Technologies Inc. This platform features an optionally tethered unmanned aerial system and a 30 mm chain gun. It will serve as the Phase II RCV (Medium) surrogate. (Photo courtesy of Textron Systems)

it to produce a vehicle today, or what was within the “realm of the possible.” The team used this knowledge to establish the vehicle’s minimum, “must meet” requirements. Because the NGCV-CFT is building vehicles for the future, not the present, the team met with actual Soldiers and asked them to define their capability wish list, devoid of any cost, physics or other logical constraints.

The NGCV-CFT wrote down every comment Soldiers provided, being careful not to dismiss a single idea. Many ideas failed to manifest themselves within vehicle requirements; however, allowing Soldiers this type of sky-is-the-limit input was invaluable for defining the program’s future objectives.

Often, and through no fault of their own, requirement authors have not recently been inside an armored vehicle roasting under

the Middle Eastern sun, nor have they carried an 80-pound rucksack across the mountains of Afghanistan at night. Additionally, requirement authors often prioritize industry’s feedback about what it can produce today, giving less consideration to a Soldier’s definition of a combat platform that has the potential to maintain its relevance in the future. Having Soldiers provide direct and frequent feedback during every phase of development is the ideal way to define the capabilities necessary to make platforms relevant decades after their initial fielding.

After defining theoretical robotic combat vehicle requirements, the team had to evaluate these capabilities in a relevant environment. We knew it had to demonstrate these capabilities to Soldiers to receive their feedback and to inform future iterations. Unfortunately, conducting multiple live experiments with surrogates or prototypes each year is not financially feasible. Therefore, the NGCV-CFT passed the baton to the Ground Vehicle Systems Center’s Soldier Experimental Gaming Analysis team to construct virtual experiments to assist with demonstrating the capabilities in a virtual and relevant environment.

### RACING VIRTUALLY

The Soldier Experimental Gaming Analysis team created virtual prototypes equipped with the capabilities and attributes defined during the NGCV-CFT’s market research efforts. Before this effort began, the Ground Vehicle Systems Center hosted numerous Soldier innovation workshops, during which Soldiers provided feedback about desired capabilities. This feedback enabled them to construct the virtual prototypes and served as critical jumping-off points for these virtual experiments.

Soldiers from across the Army traveled to Detroit to fight virtual wars and provided feedback to the Ground Vehicle Systems Center on what technology was helpful, as well as ideas for new robotic combat vehicle operating and employment techniques. Their feedback was overwhelmingly positive, indicating that the vehicle and its current capability suite were useful, thus enabling the Ground Vehicle Systems Center to pass this analysis to the NGCV-CFT, which helped to establish a priority list of desired capabilities, ranking each capability and associated performance levels. It also helped to better define the program’s possible capability trades for later phases of the procurement process.

The team then needed feedback from those who would physically construct the vehicles. Accordingly, the team provided industry with its draft requirements for review and comment. This approach not only served as a reality check for the achievability of the Army’s desired requirements, it also enabled our industry

partners to build their own teams, conduct their own market research and contemplate how they might design their virtual prototypes before receiving an official set of requirements, in an effort to move toward proposal development.

The Ground Vehicle Systems Center continued to carry the baton, analyzing the schedule and requirements, and identifying the expertise required to expand the internal team for the final sprint toward solicitation release. It was now time for the contracting experts to join the ongoing race.

### BRINGING INDUSTRY IN

To do so, the team released the draft requirements for both the light- and medium-robotic combat vehicle variants for final review and comment in May 2019. The team considered all feedback received and finalized the requirements in June 2019, when it initiated the first stage of the other-transaction agreement solicitation process, which was a request for white papers. Industry then had one month to provide a white paper addressing an overview and technical approach of their proposed robotic combat vehicle platform, addressing such factors as schedule, vendor capability, safety and vehicle performance. After an initial read, the team provided the offerors with specific feedback and requests for further information. The offerors then had one week to update their white papers.

In July 2019, our team scheduled oral reviews for every vendor who submitted a white paper. During this time, offerors had an opportunity to present their proposed concept, clarify their technical approach and address questions to the government panel of experts. Offerors had one week to finalize their white paper before resubmitting it to the government for evaluation.

The team then invited the most highly qualified offerors from the white paper phase to participate in the second phase of the evaluation—the request for prototype proposal. Similar to the first round, industry had an opportunity to update their proposals after an initial feedback round, before locking them for the final submission. The government team reviewed all final submissions before recommending the best proposal from this reduced pool to the selecting official in August 2019.

The team provided industry with a list of equipment furnished by the government, to decrease schedule risk. This equipment, such as lethality systems and autonomy systems, had previously undergone testing at the U.S. Army Test and Evaluation Center and could minimize both the time and risk associated with government safety certification. The robotic combat vehicle's radio was the most critical component of this equipment list. In a separate endeavor, our teammates at the U.S. Army Combat Capabilities Development Command C5ISR Center conducted a thorough, hands-on market research initiative resulting in the selection of a specific radio for use during the robotic combat vehicle experiments, based on the demonstrated performance of 10 different radio solutions. This approach helped stabilize the potential price disparity between vendors' proposed vehicles by holding this capability constant among all offerors.

### CONCLUSION

Currently, industry is running with the baton. Looking back on the miles behind us, we can see that in less than 18 months, the Robotic Combat Vehicle team found the best technology that enabled industry to provide platforms that are, in essence, purpose-built, as opposed to the off-the-shelf modified surrogates we anticipated receiving. These platforms, which will be used for the next live experiment, exceeded

our expectations. Our contracting teammates managed to take a spreadsheet of desired requirements and transform them into signed agreements within eight months.

The race is far from over and more competitions will occur in the future; but regardless of new challenges, both known and unknown, our team will continue to pass the baton back and forth until it crosses the finish line—which is providing the American Soldier with the best equipment as quickly as possible.

*For more information, contact the NGCV-CFT at [usarmy.detroit.ccdc-gvsc.mbx.ngcv-cft@mail.mil](mailto:usarmy.detroit.ccdc-gvsc.mbx.ngcv-cft@mail.mil).*

---

*COREY RICHARDS works as an acquisition analyst and contracting adviser to Brig. Gen. Ross Coffman, director of NGCV-CFT. She provides guidance on requirements development, regulatory compliance and competition strategies to ensure that stakeholder decisions are synchronized with Army modernization priorities and objectives. She holds an MBA from Walsh College and a B.S. in general management from Oakland University. Additionally, she is Level III certified in contracting and is finalizing her Level III certification for program management.*

*MAJ. CORY WALLACE is the robotic combat vehicle requirements lead for the NGCV-CFT in Warren, Michigan. He earned an M.A. in English language and literature from the University of Washington and an M.S. in supply chain management and logistics from the University of Kansas. He commissioned as an armor second lieutenant after graduating from the United States Military Academy at West Point in 2004.*



## MAJ. SAMUEL G. BUTLER

### COMMAND/ORGANIZATION:

Product Manager for Next Generation Weapons, Project Manager for Soldier Lethality, Program Executive Office for Soldier

**TITLE:** Assistant product manager

**YEARS OF SERVICE IN WORKFORCE:** 2

**YEARS OF MILITARY SERVICE:** 13

### DAWIA CERTIFICATIONS:

Level II in program management

**EDUCATION:** MBA with concentration in consulting and data analytics, University of Notre Dame; B.S. in civil engineering, United States Military Academy at West Point

**AWARDS:** Bronze Star (2nd award); Meritorious Service Medal; Army Commendation Medal (4th award); Army Achievement Medal (3rd award); Valorous Unit Award; Meritorious Unit Award; National Defense Service Medal; Afghanistan Campaign Medal; Iraqi Campaign Medal; Inherent Resolve Campaign Medal; Global War on Terrorism Service Medal; Global War on Terrorism Expeditionary Medal; Army Service Ribbon; Overseas Service Ribbon; North Atlantic Treaty Organization Medal; Parachutist Badge; Ranger Tab; Special Forces Tab; Combat Diver Badge; Combat Infantryman Badge; Expert Infantryman Badge

## PUSHING THE LIMITS

For Maj. Samuel Butler, striving to maintain overmatch capabilities for Soldiers is all in a day's work. As the assistant product manager for Next Generation Squad Weapons (NGSW) within the Program Executive Office for Soldier, he leads a team that is tasked with developing two new rifle systems that are revolutionizing close-combat capabilities.

"Technologically, this was not thought to be possible a couple of years ago," Butler said of the 6.8 mm NGSW – Rifle (NGSW-R) and the NGSW – Automatic Rifle (NGSW-AR). "Some folks characterized it as 'breaking physics,' but Butler said these weapons already are improving lethality and engagement distances.

"I'm incredibly fortunate to work on a program that is so relevant to the warfighter," Butler said. "Soldiers and Marines have fought with a 5.56 mm M16 variant since the mid-1960s and a version of the M249 Squad Automatic Weapon since the mid-1980s. The capabilities of 5.56 mm ammunition have largely plateaued."

The NGSW program is in the prototype phase. Three industry partners are working with Butler's team and some of the best shooters in the Army to develop the weapons. Recent tests at Fort Benning, Georgia, proved that the 6.8 mm projectile moves at a higher velocity and outperforms the ammunition currently in use by the Army. "It is unlike anything currently available," Butler said. In addition, the NGSW-R and NGSW-AR have advanced combat optical gunsights that provide six-power magnification over the standard four-power optic on existing military rifles. Equipped with sensors and laser range finders, Soldiers are able to home in accurately on targets at 600 meters as opposed to the 300 meters of modern weapons.

Butler has been in acquisition for two years, previously serving as an infantry officer and a U.S. Army Special Forces detachment commander, where he developed critical relationship skills that serve him well in his new role. "As a special forces officer, my team and I relied on host nations, partner forces and the conventional Army to accomplish our missions. Oftentimes, the critical support we were given was not required, but offered because of common ground, authentic relationships and an understanding of each other," Butler said.

"Similarly, in the acquisition world, our program relies on authentic relationships across organizations for success. On a near-daily basis, I work with the Soldier Lethality Cross-Functional Team at the Futures Command; our agreements officer and his team at the Army Materiel Command; Soldiers to inform design direction at the Forces Command; and the science and technology folks at the Combat Capabilities Development Command. If relationships are strained, it becomes very difficult to find solutions and achieve successes."

Butler's philosophy about relationships carries over to NGSW industry partners. "The work environment is challenging and dynamic, and the relationships with our vendors are very transparent and open. They trust us, and we are welcome in the doors. We see behind the curtains and understand their risks and problems."



**IT TAKES A TEAM**

Butler, in the front row, 4th from the right, gathers with Brig. Gen. Anthony Potts (front row, 3rd from right), the program executive officer (PEO) for Soldier, and the other officers, senior NCOs and civilian leadership of PEO Soldier on May 2, 2019, during one of their regular professional development events. (Photo by Jesse Glass, Picatinny Photographic Services)

Tapping into his special forces experience and connections, Butler arranged special NGSW testing events that allowed each vendor to test its specific solution for a full day at Range 37 with 15 of the best operational shooters in the Army. Range 37, located at Fort Bragg, North Carolina, is a 130-acre, 360-degree, live-fire shoothouse that tests the capabilities of special forces Soldiers. The events were not part of formal test or development plans. Vendors provided positive feedback, saying that they could not come close to replicating such events by themselves and that they want more of them.

“In the first four hours on the range, one vendor stated that they collected more feasible operational feedback than they have ever

collected before,” Butler said. To date, a total of 567 Soldiers have been involved, spending 7,658 Soldier-hours testing solutions from vendors and providing feedback to the NGSW program. “We can do these types of things because there are so many senior leaders who are interested in our success and support the program,” he said. All three vendor solutions proved to be feasible and operationally relevant during the Range 37 events.

For Butler, his ability to do his job well directly affects Soldiers in a way that is unique from his previous assignments. “As an infantry officer, I led some great Americans during deployments to Iraq and Afghanistan in challenging environments to bring stability. As a special forces detachment commander, I specialized in unconventional warfare and worked to give policy-makers options,” he said. “As an assistant product manager on the NGSW program, I am uniquely impacting Soldiers and Marines across the globe. These weapon systems will be fielded to the close combat force and employed in every combatant command’s area of responsibility. My work will provide them with a multi-generational rifle that will be their new weapon for the next 30 years.”

Butler said his greatest challenge is trying to get his boss in trouble on purpose. “Our commanding officer challenged our team to push the acquisition limits. He told us he wanted to get complaints because we are going too fast and challenging the status quo. It’s been both awesome and rewarding to push the traditional boundaries that many organizations find comfort in, so that we can get these weapons into the hands of Soldiers and Marines who need them.”

—TERESA MIKULSKY PURCELL



**AIMING HIGH**

Butler at a controllability range at Aberdeen Proving Ground, Maryland, in November. He leads a team assigned to develop two rifle systems that will replace weapons used for more than half a century in one case and about 35 years in another. (Photo by Maj. Samuel G. Butler, PEO Soldier)

# EMPHASIZE SUPPORTABILITY EARLY

| A system may be innovative, but a host of unforeseen supportability issues could limit its availability to Soldiers in the field.

*by Christopher Applegate, Joseph Cannataro and Chia W. “Jeff” Lee*

**I**nnovative technology and associated system performance improvements are laudable goals to pursue, but success of a system is also measured by how well, how long and how efficiently they serve the Soldier over time.

Armament system developers must consider all factors that could undercut readiness and increase sustainment or “supportability” costs. Identifying these supportability and cost burdens, which are rooted in early design decisions, is paramount for the success of a system.

From a cost perspective, it’s critical to “design out” potential supportability problems since about 60–80 percent of the life cycle cost of a system is incurred during the operation-and-support phase of the life cycle. (See Figure 1, Page 54,)

In an effort to minimize large operation-and-support costs, the U.S. Army Combat Capabilities Development Command Armaments Center (CCDC AC) has taken a fresh look at how we design armament systems during the early phases of the acquisition life cycle, evaluating various options to provide an overall system solution.

Maintaining readiness is vital—taking a holistic view early in system design and development is critical to the system’s eventual and overall usability. A system design may meet all performance objectives, but it wouldn’t be useful if its

capability were unavailable because it imposed an unrealistic maintenance burden, or required support equipment that is not readily available. Perhaps it can’t be shipped and distributed via existing means, or perhaps existing facilities are inadequate to support the developed system. The design may also be prone to cyberattack. These supportability concerns must be considered to ensure that the ultimate system into which a technology is inserted will meet the desired readiness and availability.

According to logistics training material from Defense Acquisition University, operation-and-support costs may include those associated with:

- Software updates and upgrades.
- Protection against cyberattacks.
- Hardware repair, overhaul, reset and retrograde.
- Data conversion and cleaning.
- Software and hardware obsolescence mitigation.
- Demilitarization and disposal.
- Facility modifications for training, maintenance and storage.
- Tools and equipment for repair and maintenance.
- Training.

FIGURE 1

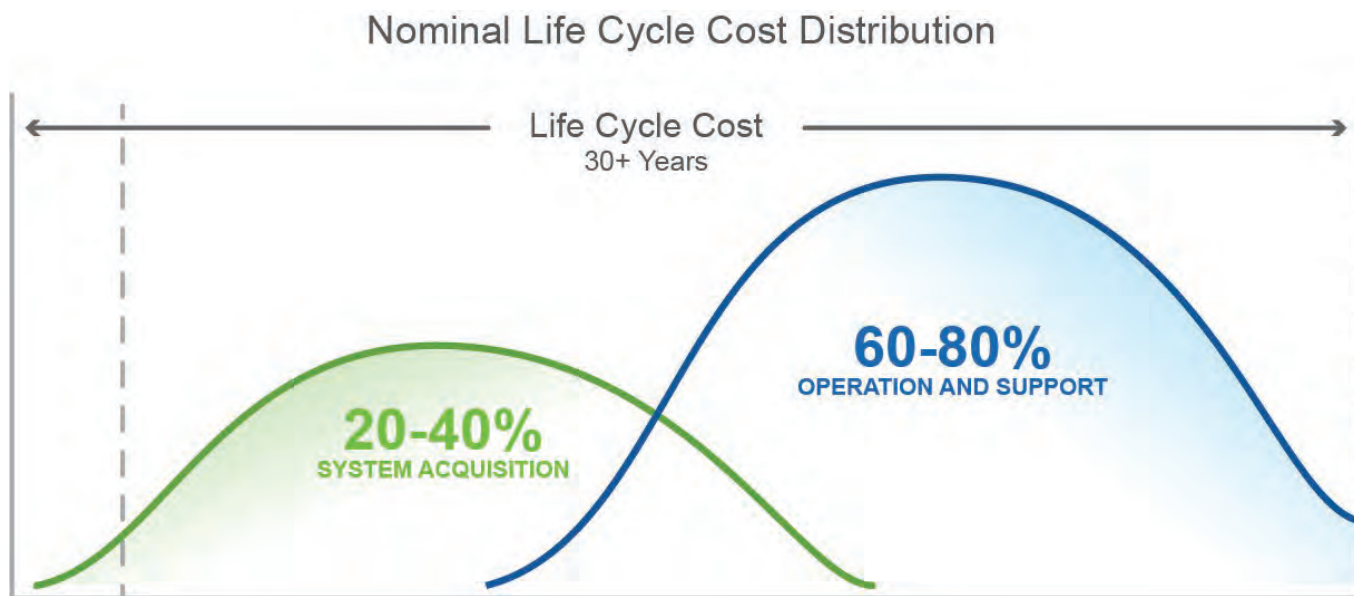

**DESIGNED INTO THE SYSTEM**

This life cycle cost distribution model for a system shows the majority of costs are incurred during the operation-and-support phase. Many of those operation-and-support requirements are designed into the system during development. (Image by Defense Acquisition University)

A 2003 report by the U.S. Government Accountability Office focused on weapon system total ownership costs. It determined that up to 90 percent of these operation-and-support costs are locked in by the time a product is developed and ready for production. (See Figure 2, Page 55.)

Even though this report is somewhat dated, we still believe it is relevant to today’s acquisition life cycle. For ammunition and associated items (Supply Class V), operation-and-support costs are believed to be less, but still a significant portion of the overall life cycle costs because of several different factors—for example, you cannot get back spent bullets. (See Figure 1.) Additionally, ammunition usually doesn’t have parts that require scheduled maintenance, repairs or upgrades. These costs have a huge impact on the ability to sustain fielded systems.

CCDC AC has introduced several initiatives that will drive engineers and scientists toward identifying and addressing supportability issues at an early stage. The goal is to “design out” these issues or, at the very least, properly identify these issues as risks to our stakeholders and to our partners who will receive this technology and mature it further for production.

Realistic planning and resourcing can be achieved by program managers when the science and technology community can identify supportability risks before transition, thus ensuring successful programs and eventual fielding of the capabilities.

**SUPPORTABILITY SPECIALISTS**

One initiative is the Science and Technology Supportability Cell at the Armaments Center, which was established in 2017 and currently has a staff of six people. This group’s mission is to assess emerging armament system designs for any supportability issues and opportunities across all science and technology efforts. The cell does this by using various personnel, processes and tools to identify, analyze and evaluate supportability implications.

This cell comprises supportability project officers who have various engineering and life cycle logistics backgrounds and a capability to apply their knowledge and experiences in the abstract. That would entail taking designs of potential systems and envisioning how they will be used and function if they were fielded now, and extracting from that concept the impacts or considerations needed so that it can be supported. Before being integrated into science and technology projects, the Science and Technology



FIGURE 2

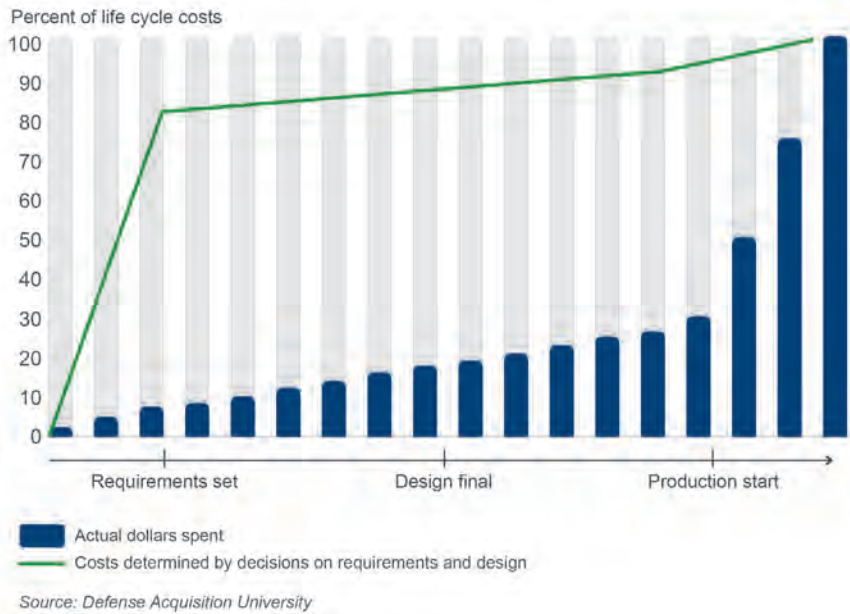

Supportability Cell conducts an assessment of the projects within the portfolio to identify the major projects that have the strongest needs for supportability analyses and improvements.

These supportability project officers provide the initial assessment and identify necessary follow-on tasks, taking the burden off the project lead. They serve as the single point of contact for all supportability-related tasks. These tasks detail the specific assessments, analyses and evaluations necessary to address supportability concerns, implications and opportunities.

The tasks are then given to the project lead for inclusion into the overall project plan. An internal document at CCDC AC provides guidance to project leads on how to assemble a team and what tasks the project lead is responsible for—it guides the leads in the steps of project initiation and management. In situations where resources are not available to fully analyze or mitigate supportability concerns, someone is designated to track the risks associated with a project and include them in a risk profile, so the project lead can focus on the project as a whole.

These assessments provide the entire project team insight into cause-and-effect relationships between certain design decisions and the potential impact to the Soldier and the Army infrastructure. To accomplish their objectives, supportability project officers use various engineering tools and techniques such as risk analysis, failure modes and effects analysis, and supportability analysis.

In addition to these tools, supportability project officers have access to some totally new and unique tools, such as the Logistics Map (LOGMAP) and the Life Cycle Impact Analysis Tool, which were

### PRODUCTION LOCKS IN COSTS

This 2003 report, “Setting Requirements Differently Could Reduce Weapon Systems’ Total Ownership Costs” (GAO-03-57), details when life cycle costs are locked in. Once a system enters production, 90 percent of that cost is already locked in. (Image by U.S. Government Accountability Office)

developed by the Armaments Center as part of separate initiatives.

LOGMAP adds value to the project management process used at CCDC AC, the Armaments Technology Development Process, by providing guidance to the life cycle engineering community on recommended actions and analyses that should be done at specific times within the process.

LOGMAP identifies when specific actions should be taken in relation to other project tasks, allowing logistics engineers and logisticians to synchronize their actions with those of the other project engineers. It allows for the development of a supportability road map within the science and technology environment for each project.

It provides guidance to supportability project officers with respect to the high-level “how, what and when” actions that should be taken.

### ASK THE RIGHT QUESTIONS

The Life Cycle Impact Analysis Tool is a software-based tool that helps supportability project officers and project team members identify potential supportability and cost burdens by answering a series of questions. It “speaks” to the design engineers, asking questions on intricate design details that have a profound impact on the eventual support needed for the system rather than asking basic “compliance” questions.

Currently, the tool contains more than 500 questions that were derived from

several logistics-based references such as the Product Support Manager Guidebook, Independent Logistics Assessment—a document used to analyze the supportability planning of a program—and Army Regulation 700-127 “Integrated Product Support”. Furthermore, experts and lessons learned helped take the information contained in the reference documents and tailor which questions should be answered, to better be in line with what projects should be looking for. Example questions include:

- Does this technology require new maintenance skillsets and levels?
- Does this technology application require facility modifications such as handling, storing, operating or maintaining?
- Is nonstandard test equipment needed for this technology?
- Does this technology require special handling equipment or other enablers to use?
- Does the design optimize the use of common parts and material and minimize the use of peculiar or unique parts within the system?
- Does this technology application require standard personal protective equipment for using or maintaining the technology?
- Does the technology require a power source?
- Does this technology require a humidity-controlled environment for storage?

These example questions are simple and relatively straightforward but are often overlooked during early design development. In addition, these questions can be customized to include additional detail for a more specific situation.

The questions contained within the Life Cycle Impact Analysis Tool are all-encompassing and touch on all 12 of the integrated product support elements. These questions help drive discussion and identify potential supportability burdens. The tool takes it a step further, providing a qualitative analysis based on answers to the questions.

The tool uses the answers to these questions to assess “high,” “medium” and “low” impacts on sustainment. These impacts then help derive associated risks so that plans can be developed to mitigate, eliminate or track. The tool provides an iterative process to analyze alternatives for design, to assess risks at each stage of the project and to provide valuable input to life cycle sustainment plans. The tool

is intended to be ever-evolving, allowing for questions to be refined and customized based on lessons learned.

There have been several early successes in the implementation of LOGMAP, the Life Cycle Impact Analysis Tool and supportability project officers. In one situation, a design review revealed potential issues with maintenance and cleaning and with supply of barrel-shroud components for a weapon system in development. The supportability project officer identified several implications with the design, recommending that the team explore the use of 3D printing to produce a better geometric venting design of the shroud, which would be easier to maintain and would reduce the need for additional spare parts.

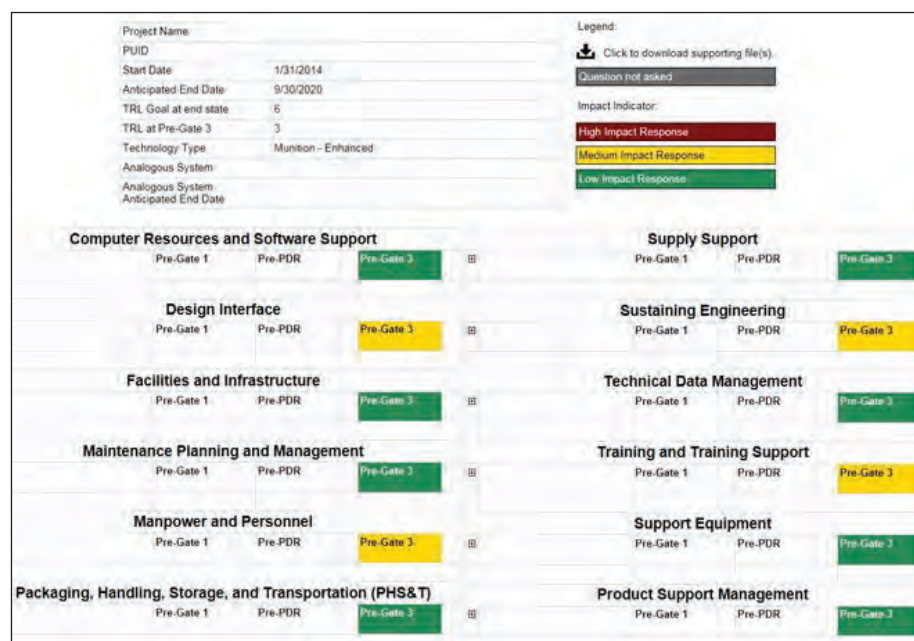

### SHOW ME THE MONEY

A Life Cycle Impact Analysis Tool impact summary report at the product support category level. These reports also show the user how assessments have progressed through each iteration as the project goes through major programmatic or technical reviews. (Image courtesy of the Science and Technology Supportability Cell, CCDC AC Logistics Research and Engineering Directorate)



### A UNIQUE TOOL

Registered users can access and use the Life Cycle Impact Analysis Tool's assessment functions. This tool helps supportability project officers and project team members identify potential supportability and cost burdens. (Image courtesy of the Science and Technology Supportability Cell, CCDC AC Logistics Research and Engineering Directorate)

Additionally, the 3D printed solution would also reduce materiel costs of the component, providing an inexpensive alternative to the initial design.

In another situation, during a product design review for the development of a rifle fire-control system, the supportability project officer identified potential issues with the placement of the control housing unit, which contains the software and associated components to operate the system, and its impact on other components.

The supportability project officer recommended that the team obtain user feedback gathered for other, comparable fielded systems to explore different design options that would minimize wear on the other system components.

With the integration of supportability project officers onto science and technology projects and the use of these newly developed tools, CCDC AC has taken the first step toward making supportability an integral part of development and providing best value solutions to our customers.

These initiatives provide the engineering community with a broader sense of the effect that the capabilities they are

developing will have on total ownership cost, on the logistics footprint and on readiness, thus providing greater fidelity to the trade space and ensuring selection of the best value solution. They provide another means of safeguarding the availability of future systems for the Army.

### CONCLUSION

An emphasis on supportability helps to ensure that a system can have a long and effective life in the field and reliably support Soldiers in achieving their mission objectives. Mitigating supportability issues later in the life cycle can be prohibitively costly and time-consuming, thus hindering readiness. Keeping supportability at the forefront of early system development can require some adjustment in thinking, but the benefits are clear and compelling.

For more information, go to <https://ac.ccdc.army.mil/organizations/esc/LRED/>.

*CHRISTOPHER APPLGATE is deputy director of the Logistics Research and Engineering Directorate (LRED) of the CCDC Armaments Center, where he helps shape efforts within the organization to meet strategic objectives. He holds a Master of Engineering in systems engineering from Stevens Institute of Technology and a B.S.*

*in mechanical engineering from Wilkes University. He is a member of the Army Acquisition Corps (AAC).*

*JOSEPH CANNATARO is the competency manager of the Life Cycle Supportability Division within LRED. He manages a team of engineers and other professionals responsible for identifying, analyzing, developing and managing supportability considerations for weapon system programs. He holds an MBA from the Florida Institute of Technology, a B.S. in electrical engineering from the New Jersey Institute of Technology, and various certificates in leadership and management. He is a member of the AAC.*

*CHIA W. "JEFF" LEE is the associate director for supportability integration, supervisory for the Science and Technology Supportability Cell, and the supportability project officer on the Extended Range Cannon Artillery project. He manages a team of supportability project officers to assist many science and technology projects and coordinate supportability analysis and design activities early in the life cycle. He holds an M.E. in systems engineering from the Stevens Institute of Technology and a B.S. in industrial engineering from Rutgers University. He is a certified internal auditor for ISO9000 and CMMI quality management frameworks and a member of the AAC.*



**BRIEFING THE BOSS**

Secretary of Defense Dr. Mark T. Esper listens to biological safety officer David Harbourt during a tour of USAMRIID at Fort Detrick in March. (Photo by John W. Braun Jr., USAMRIID)

# CENTER STAGE ON COVID-19

Medical Research and Development Command is a key contributor to Army, DOD pandemic response plan.

*by Ramin A. Khalili*

Following a visit to the U.S. Army Medical Research and Development Command (USAMRDC) at Fort Detrick, Maryland, on March 17, Secretary of Defense Dr. Mark T. Esper spoke to reporters at the Pentagon regarding the Army's role in combating the COVID-19 pandemic. "The Army's work on a vaccine is one of the many ways the Department of Defense is supporting President Trump's 'whole-of-government' approach to fight the virus and substantially slow its spread," said Esper, launching a coordinated effort to position USAMRDC as one of the key contributors to the federal response to COVID-19.

Esper's visit was the centerpiece of a busy month at USAMRDC, which saw similar visits from Secretary of the Army Ryan D. McCarthy, Army Chief of Staff Gen. James C. McConville and Sergeant Major of the Army Michael A. Grinston in the same week. "The chance to talk to the doctors face to face was really helpful to me in understanding what they're doing," Esper said of his visit. "They've been very successful in the past, whether it's dealing with Ebola or Zika, [and] they have incredible capabilities."

Recent successes in combating the Ebola virus underline the command's robust track record in mobilizing infrastructure and delivering results when faced with emerging infectious disease threats. In late 2019, after a more than 15-year journey and following initial testing and several preclinical trials performed at USAMRDC's U.S. Army Medical Research Institute of Infectious Diseases (USAMRIID), the U.S. Food and Drug Administration (FDA) approved the first vaccine to prevent Ebola, marketed under the trade name Ervebo.

## READY TO RESPOND

This record of success ensures that USAMRIID is well-poised to support the COVID-19 pandemic response. Scientists at USAMRIID received a sample of SARS-CoV-2, the virus that causes COVID-19, from the Centers for Disease Control and Prevention (CDC) in February. The institute is developing models that represent the course of the

disease in humans. These models will be used to evaluate vaccines, diagnostics and therapeutics developed by USAMRIID and its partners.

In addition, USAMRIID has the capability to perform screening of small molecules for drug development, and is screening thousands of drugs simultaneously to look for activity against the current coronavirus manifestation. USAMRIID leaders and virus experts are also part of a COVID-19 task force charged with providing updates to senior Army leaders on a daily basis.

During his visit to USAMRIID, McCarthy notably referenced USAMRDC’s three key lines of effort in the battle against COVID-19—prevention, detection and treatment—and their enduring importance in combating the virus. In addition, McCarthy mentioned the development of several vaccine candidates within USAMRDC and across the private and public sectors. “We’re learning every day,” he said during a post-tour meeting with reporters at USAMRIID. “We are getting smarter with regard to this problem every day.”

In remarks during his visit, McConville noted the impact of the pandemic on recruiting efforts, noting that the Army has already begun to test for the virus in both new and potential recruits. McConville further confirmed that additional testing of enlisted Soldiers in the following one- to two-month period would help determine the overall risk to the force, at which point Army leaders would be able to determine the impact of COVID-19 on the overall mission. Showing his gratitude to the Army researchers, physicians and scientists working to develop medical countermeasures against COVID-19, McConville said, “We are proud of them and we support what they’re doing.”

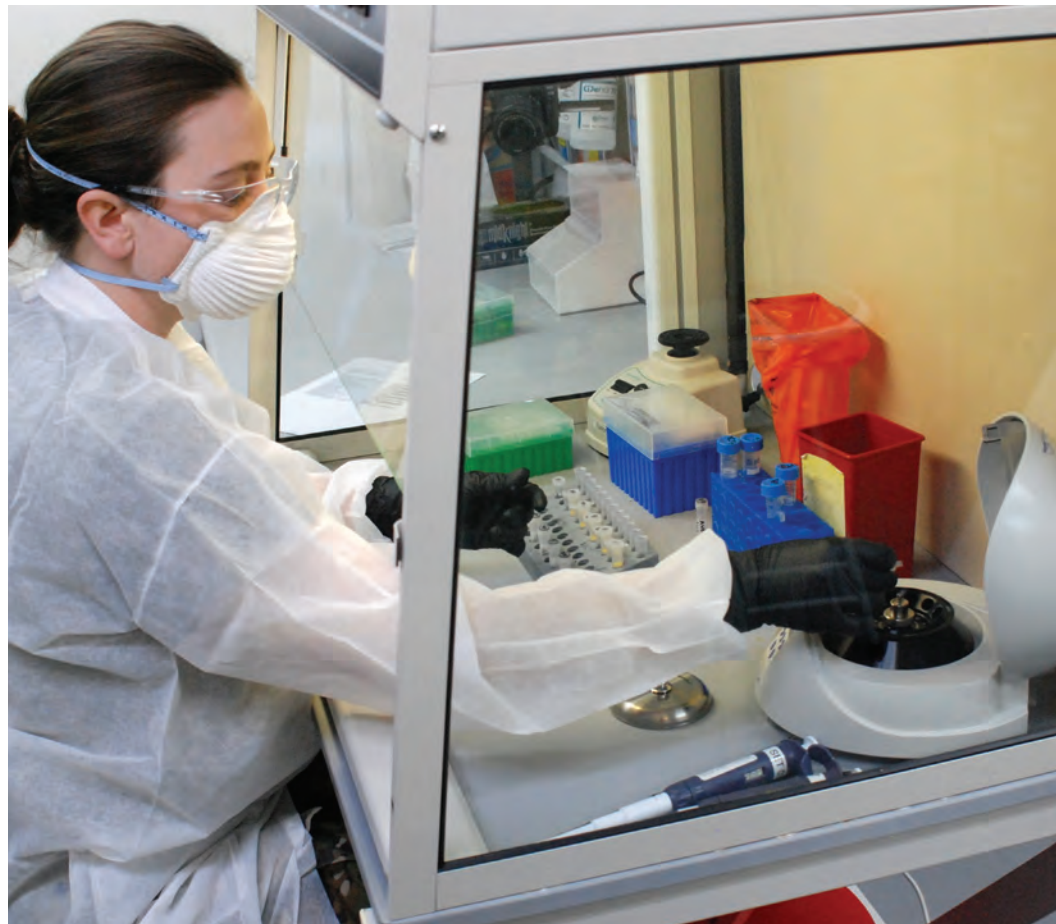

**TARGET: COVID-19**

Spc. Taylor Wolik, a medical laboratory specialist with the 1st Area Medical Laboratory, performs a diagnostic assay at USAMRIID in March. In the battle against COVID-19, detection is one of three major lines of effort, the other two being prevention and treatment. (Photo by William F. Discher, USAMRMC)

**FAR-RANGING DEVELOPMENTS**

As for current research projects taking place at USAMRDC, Brig. Gen. Michael J. Talley, commanding general of USAMRDC and Fort Detrick, was quick to assure the public that those efforts will continue unabated. “Your health and safety remains our top priority,” said Talley during a livestreamed town hall with staff and the community on March 16. “I am committed to doing everything to keep you healthy and to keep us mission ready.”

USAMRDC’s efforts extend to the command’s other laboratories as well. The Walter Reed Army Institute of Research (WRAIR) is hard at work on the COVID-19 response, having produced prototype vaccines from which it will ultimately select one, based on testing, to move forward into initial clinical testing in humans. WRAIR is also publishing the highest-quality images of the COVID-19 virus spike—the spindle that protrudes from the virus itself, and by which the virus attaches itself to the lungs—which

are serving as a road map for vaccine and therapy development. By better understanding that specific portion of the virus through images like those WRAIR has developed, scientists can better determine how to prevent it from infecting people.

The command's partnerships with industry and academia are bolstering efforts during this time. WRAIR, for example, is actively working with the National Institutes of Health and industry partners to evaluate promising vaccines in various stages of development. WRAIR is also collaborating with the Army Public Health Center on a pilot project that will include blood tests for COVID-19 exposure in Army recruit training, to reduce the threat of exposure and impact on recruits while in training.

USAMRDC's U.S. Army Medical Materiel Development Activity (USAMMDA) recently entered into a cooperative research and development agreement with Gilead Sciences Inc. to use the investigational drug remdesivir to treat active-duty Army personnel exposed to COVID-19. The drug was shipped to 13 military treatment facilities. An investigational drug

**“The chance to talk to the doctors face to face was really helpful to me in understanding what they’re doing.”**

is a substance that has been tested in the laboratory and has been approved by the FDA for testing in people.

Additionally, USAMMDA contributed medical materiel expertise to the virus response effort following the late March deployment announcement of a handful of hospital centers and combat support hospitals. The USAMMDA Warfighter Deployed Medical Systems (WDMS) team has been tasked with filling shortages for the deploying units by surveying current equipment stock, cutting stock transfer orders to facilitate delivery of key materials and coordinating with a slew of other agencies, including U.S. Army Sustainment Command and U.S. Army Materiel Command, to ensure that deploying units have the equipment required to perform

their missions. “We have been working on ensuring any shortages in equipment for the mission are top priority to fulfill,” says Lindsay Longobardi, deputy project manager for WDMS. “Our team has exercised multiple contracting actions to ensure critical care medical devices [are] shipped to the units [and] on the ground in as little as 24 hours.”

Several other Army laboratories are lending their expertise in the fight against COVID-19. The U.S. Army Aeromedical Research Laboratory performed a rapid-response evaluation of aircrew performance while wearing an N-95 mask and various models of cloth masks to assess the effects of wearing the mask for speech intelligibility, usability, workload, situational awareness and comfort,

## MEET THE PRESS

Secretary of the Army Ryan D. McCarthy listens to a question from a reporter during a news conference at USAMRIID in March. McCarthy, Army Chief of Staff Gen. James C. McConville, right, and Sergeant Major of the Army Michael A. Grinston visited USAMRIID to understand how the Army medical research and development community is responding to the COVID-19 pandemic. (Photo by Erin Bolling, USAMRDC Public Affairs)





**CULTURE PREP**

USAMRIID scientists prepare cultures for a testing exercise at Fort Detrick in March. (Photo by Ramin A. Khalili, USAMRDC Public Affairs)

to determine what masks are compatible with safe flight. According to the CDC, the N-95 mask filters out at least 95 percent of airborne particles—including both large and small particles—when properly fitted and donned, making it a higher, more professional-grade mask. The lab is also testing several patient isolation units to possibly transport COVID-19 patients on U.S. Army and Army National Guard medical evacuation aircraft.

At the U.S. Army Institute of Surgical Research, scientists are using results from previous hemorrhagic shock studies to identify parts of the blood that confer immunity in patients who have recovered from COVID-19 infections. This is known as “convalescent plasma,” and the technique has the potential to treat patients infected with COVID-19.

For USAMRIID and WRAIR, the focus continues to be a vaccine. According to Esper, it will likely take USAMRDC-affiliated labs between 12 and 18 months to develop a functional COVID-19 vaccine, a time frame echoed by several other federal agencies and experts. However, to spur cooperation with private industry partners, Esper has touted USAMRDC’s capabilities in testing and evaluating vaccines developed by other entities. Efforts in the lab will, of course, be complemented by pandemic response initiatives in local hospitals and communities across the country, as federal and DOD support continues to expand.

“If we can dramatically reduce the spread of the virus,” said Esper, “then together we can help restore public health and the economy and hasten a return to our normal way of life.”

*For continuous updates on the USAMRDC response to COVID-19, go to <https://mrdc.amedd.army.mil/index.cfm/resources/covid-19>. For more information about the USAMRDC, go to <https://mrdc.amedd.army.mil>.*



**BACK AT THE PENTAGON**

Secretary of Defense Mark T. Esper delivers remarks at the Pentagon following his visit to USAMRDC in March. (DOD photo)

*RAMIN A. KHALILI is a writer with the USAMRDC Public Affairs Office. Before assuming his current role, he spent several years as the knowledge manager for the USAMRDC’s Combat Casualty Care Research Program. During his previous work as a broadcast journalist, he earned an Associated Press Award for his work in Phoenix, before serving as chief NASA correspondent for CBS in Orlando, Florida. He holds a B.A. in communications from Penn State University.*



# THE HALO EFFECT

Army rolls out simpler, lighter software to support electronic health records during COVID-19 pandemic.

*by Paul Clark*

## READY FOR PATIENTS

Soldiers stage medical equipment and beds at the CenturyLink Field Event Center in Seattle in March, as part of the Army's response to the coronavirus. MC4 systems were part of the deployment to Seattle. Note two MC4 laptop systems on a table at lower left. (Photo by Canadian Broadcasting Corp.)

The Army's Health Assessment Lite Operations (HALO) application was deployed to medical forces during the COVID-19 pandemic. HALO is a digitized version of the Standard Form 600 used by DOD medical personnel to document patient treatment for wounded, injured or sick patients. The software was developed by the Medical Communications for Combat Casualty Care (MC4) product management office, the Army acquisition program with primary responsibility for providing Army operational health information technology for deployed medical forces. The current version of HALO is designed primarily for documenting outpatient treatment at Role 1 battalion aid stations and Role 2 military treatment facilities.

After HALO was successfully launched on Nov. 15 at the U.S.-NATO hospital in Kabul, Afghanistan, an updated version was ready for a planned Army rollout to deployed units worldwide. However, no one could have predicted using the application in response to the COVID-19 crisis a few months later.

In early March, the MC4 program started its COVID-19 efforts by providing equipment, training and technical support to dozens of Army medical units worldwide. At the Carl R. Darnall Army Medical Center at Fort Hood, Texas, training and support was provided to medical staff of the 581st Medical Company Area Support, who were screening medical patients at the hospital. The program deployed field service representatives to the CenturyLink Field Event Center in Seattle, Washington and to the Javits Center in Manhattan, New York. Army medical providers giving COVID-19 support in New York have documented over 600 patient encounters using HALO through April 15, with a number of additional sites planned.

In February 2020, in order to learn more about these recent developments and the next steps for HALO, I sat down with MC4 Product Director Tracy Ellis and MC4 Technical Management Division Chief Jay Patnaude, who oversees HALO's development.

**Paul Clark:** Can you tell me about electronic health records (EHRs) and why

**In the first two days of use, three times as many electronic patient encounters were documented than in the two weeks leading up to the HALO go-live date with the legacy AHLTA-T.**

**—HALO deployment to Afghanistan on Nov. 15, 2019**

they are important to operational medical forces?

**Tracy Ellis:** Documenting health care for deployed service members is a critical part in continuity of care, patient safety and ensuring that proper medical care is provided when they leave the service.

Electronic documentation has many advantages over paper records. When there



**CHECK THE RECORDS**

MC4 field support representative Craig McDowell assists in setting up the Application Virtual Hosting Environment (AVHE) that allowed the 121st Field Hospital Isolation Center to remotely access hospital records during the COVID-19 response on March 24. (Photo by MC4)



### UP AND RUNNING

Soldiers of the 627th Hospital Center use MC4 system laptops during the COVID-19 response at the CenturyLink Field Event Center in Seattle on April 7. (Photo courtesy of KOMO ABC 4 News)

is network connectivity, EHRs can be transmitted in seconds and are then viewable by medical personnel with network access. Electronic records also aren't as easily lost when compared to paper records. Information in the electronic record can be datamined to support medical research and to provide leadership with near-real-time information for use in decision-making. Finally, a comprehensive, lifelong EHR provides medical information to ensure that the service member gets the right care at the right time—whether in service or when their care transitions to the [U.S. Department of Veterans Affairs] or civilian sector upon separation.

**Clark:** What operational challenges does this present?

**Ellis:** In operational settings, the No. 1 issue is that network communications are not always available or can become

degraded—the term used by the military is disconnected, intermittent or low bandwidth. That is why there's a requirement that deployed operational health IT systems have the ability to continue to document health care in a degraded network environment. While the legacy AHLTA-T [Armed Forces Health Longitudinal Technology Application – Theater] EHR software provides this capability, it depends on a server to store the patient encounter. If the connection between the provider's computer (i.e., the client) and the server is lost, it requires reconfiguring the provider's computer as a client-server to operate in this environment. This is normally handled by deployed personnel with systems administration expertise—who may or may not even be co-located with you. HALO was designed specifically to allow electronic documentation to continue and then forward the patient encounters once communications are restored, with no additional steps required.

## “The beauty of HALO is its simplicity. It is easy to use, and overall it’s a vast improvement over AHLTA-T.”

—Maj. Paul Schunk, an emergency care physician in a post-deployment survey given Nov. 19, 2020, at U.S.-NATO hospital, Kabul, Afghanistan

**Clark:** If HALO is designed for situations with low bandwidth, or when network communications go out, can you explain how that works; perhaps provide a scenario?

**Ellis:** Much like your internet and cable in your home, the time it takes to install your cable connection, and issues such as weather, technical issues, user error and low bandwidth, can all affect your service. Take all of these factors, then add in potential for disruption of the communications network by our adversary, and you can see examples that could create a disconnected network environment that could last from a few minutes to a few days or longer.

**Clark:** You began HALO deployment in Afghanistan back in November. How did that go?

**Ellis:** The November deployment to Afghanistan exceeded our expectations. Forty-one hospital staff members (20 U.S., 21 NATO) received two hours of HALO training prior to the software’s go-live date. Most were able to document patient care electronically using HALO without further assistance from the HALO training team.

**Clark:** Can providers communicate with each other through the application? Can you explain a bit about its capabilities?

**Ellis:** HALO allows a patient encounter to be open and accessible to other providers who may have a requirement to also

provide documentation or co-sign. An example might be the physician who is documenting his or her notes while a medic is continuing to monitor and document vital signs. HALO provides an alert anytime more than one individual is documenting in the open patient encounter. The legacy AHLTA-T software does not allow more than one individual to access the open encounter.

**Clark:** So how does HALO save the Army money?

**Ellis:** Because HALO is simple and easy to use, the savings are realized by reducing the number of hours spent on trainers and training. Since HALO is so easy to support, it will allow Army IT personnel to spend more of their time supporting other applications. And the small size of



### FIT FOR PURPOSE

Development of the HALO software started in 2017 on the lightweight, fit-for-purpose solution that provides medics and providers an easy-to-use, simple interface for capturing health data on patient encounters. (Photo by the author)

the HALO application compared to the legacy application has the potential to reduce hardware costs.

**Clark:** As an Army acquisition program, what are you doing to support the Army’s leadership priorities and support multidomain operations? In other words, how does MC4 remain relevant?

**Ellis:** The deployment and further development of HALO supports the Army’s priorities—people, readiness, modernization and reform. Improving the ability to document care for Soldiers supports health care delivery, which is all about taking care of people. Advances in operational health information systems, such as HALO, provide real-time data in support of medical mission command. This helps maintain readiness through the ability to rapidly shift resources in support of the fight. While the focus of this interview is on HALO and electronic health care documentation, MC4 deploys operational health IT solutions that support all 10

health care functions, including medical logistics, preventive medicine and medical mission command. In each of these areas, we see the value of lightweight, scalable, cost-effective solutions that incorporate commercial off-the-shelf hardware and software solutions that can be rapidly modified and deployed in support of multidomain operations ranging from early-entry operations through large-scale combat operations. And the rapid, incremental delivery of capability is consistent with modernization and reform efforts by leveraging the power of operational health information systems to help maintain the Army’s competitive edge.

**Clark:** Isn’t the DOD already moving out with modernizing its EHR? Why not just use that solution in the deployed environment rather than develop an application like HALO?

**Ellis:** Military Health System Genesis is military medicine’s modernized, enterprise-level EHR that has also been adopted

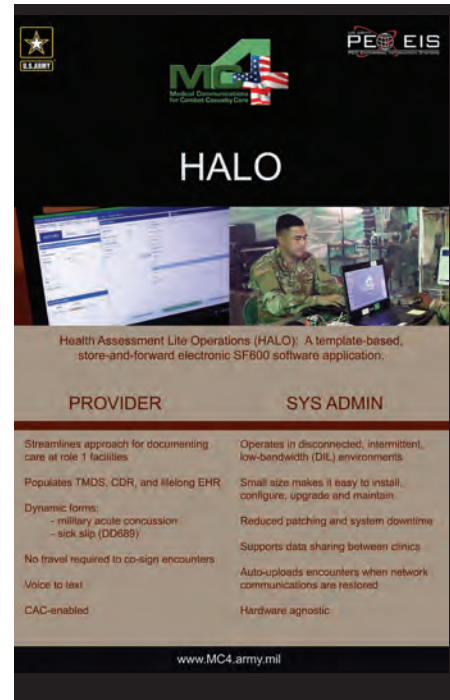

**EASY DOCUMENTATION**

Providers can co-sign patient encounters and health documentation. (Photo by the author)

by the VA. But it is not ready to field to operational forces. Until it is ready, being satisfied with the legacy operational health care applications is not the answer, especially when there are opportunities to rapidly deliver enhancements and additional capability in the interim to our deployed Soldiers. HALO is an example—a cost-effective improvement over the legacy EHR that will serve as a bridging solution until the modernized solution is ready to deploy to operational forces.

**Clark:** How many encounters can be pushed at the same time? Where does the data go?

**Jay Patnaude:** The transfer of the medical encounters is seamless. Regardless

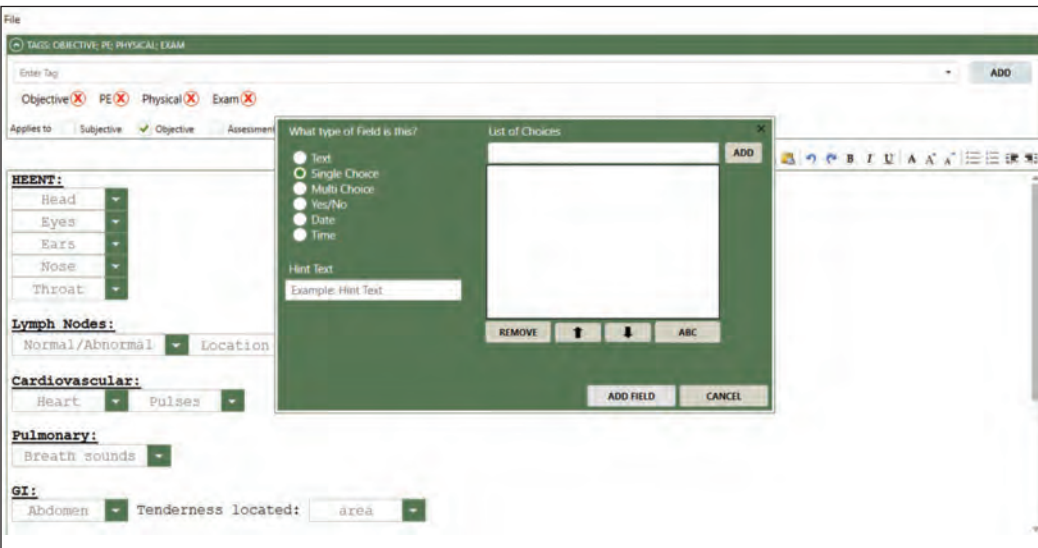

**STANDARD PRACTICE**

The HALO software application is essentially an electronic Standard Form 600. (Photo by the author)



**BLOOD SIMPLE**

During an exercise in 2019 at Fort Detrick, Maryland, PFC Byron Pascua uses the MC4 scanner to document blood using MC4 systems. (Photo by the author)

of whether the medic has communications or not, HALO is designed to constantly monitor for a connection and when it has one, it automatically bursts encounters to the HALO hub [server] it's connected with. The HALO hub will then transmit encounters to Theater Medical Data Store and the Clinical Data Repository, the Soldier's lifelong EHR. HALO has the ability to send data in any format to any medical system that it's allowed to communicate with.

**Clark:** Is HALO compatible with AHLTA-T and other applications?

**Patnaude:** HALO is a lightweight software at only 90 megabytes in size. It's designed to work with AHLTA-T and can communicate with any other application. It's also what we call hardware agnostic [meaning the software is compatible or interoperable with a variety of standard devices, laptops, smartphones, desktop computers and tablets].

**Clark:** Is the training intensive?

**Patnaude:** No. HALO was specifically designed to be easy to use. There are online training materials for HALO; however, most medics pick up how to use HALO in five to 10 minutes.

**Clark:** It's really that easy?

**Patnaude:** Yes. In fact, from what we've seen so far, after that initial interaction, we just let the medics explore the HALO application and answer questions as they come up. They intuitively get it after only a few minutes of use.

**Clark:** Does HALO require a lot of support?

**Patnaude:** No. HALO is designed to be updated remotely by pushing software to the locations throughout theater. If a unit is not on the network, then we can send them one CD and the unit's S-6 can easily patch or upgrade the system.

**Clark:** What stood out for you from the November 2019 Afghanistan post-deployment survey on the level of satisfaction between HALO and AHLTA-T?

**Patnaude:** I thought it was pretty revealing to see the comment from an emergency room nurse [Capt. Lesley Tarongoy, U.S.-NATO hospital, Kabul, Afghanistan]. She wrote an emphatic "NO!" when asked if she wanted to go back to AHLTA-T after using HALO. To see similar answers given by 100 percent of the respondents was pretty satisfying.

For more information, go to [www.mc4.army.mil](http://www.mc4.army.mil).

---

*PAUL CLARK provides strategic communication support to MC4 for CACI International. He writes about the MC4 acquisition program and topics supporting Army operational health information technology that impact deployed medical forces. He is a veteran of the U.S. Army and has a B.S. in biology from Northern Arizona University.*

**Through January 2020, over 1,000 patient encounters were documented using HALO by providers at HKIA, according to MC4. Many of these encounters were previously documented on paper.**

**—HALO patient encounters verified in the Theater Medical Data Store between November 2019 and January 2020, U.S.-NATO hospital, Kabul, Afghanistan**



#### FIRST ENCOUNTER

Medical providers register the very first patient encounters using HALO at the Role 2 hospital at Kabul, Afghanistan, on Nov. 15. (Photo by MC4)



### **SUPPORTING THE SOLDIER, LITERALLY**

For dismounted Soldiers in the field, one of the most common injuries is from carrying nearly 100 pounds of gear for extended periods, often over rough terrain. But exoskeletons like the Human Universal Load Carrier could help the injured warfighter maintain mobility and combat-effectiveness. (Photo by David Kamm, Combat Capabilities Development Command Soldier Center)



# PRESERVING LIVES ON THE NEW BATTLEFIELD

Field medical care takes new directions as the shape of military conflict changes.

*by James A. Black, Lt. Col. David S. Johnston and Col. Michael R. Davis, M.D., FACS*

The U.S. Army Medical Research and Development Command (USAMRDC) has learned valuable lessons by studying the Second Battle of Fallujah, which took place in Iraq between November and December 2004. Military historians called it some of the heaviest urban combat that U.S. Marines and Soldiers had seen since the Battle of Hue City in Vietnam in 1968. From an operations and medical perspective, this battle provides the military with strategic lessons that will enable the U.S. to prevail in close-quarter armed conflict with near-peer adversaries, such as Russia and China.

More than 300,000 residents vacated Fallujah before the battle in anticipation of a protracted struggle that could have produced catastrophic collateral damage. The Iraqi insurgents and foreign mujahedeen present in the city fortified their defenses in advance of the anticipated U.S. attack: digging tunnels, preparing trenches and hiding scores of improvised explosive devices in “spider holes.” The insurgents’ tactics included booby-trapping buildings and vehicles, wiring doors and windows with grenades, and using Jersey barriers within homes to create strong chokepoints from behind which they could attack unsuspecting troops entering the building.

While U.S. coalition forces ultimately prevailed, the insurgents inflicted more than 100 casualties and kept our troops at bay during protracted house-to-house fighting. U.S. strategists surmised that had Fallujah been a battle with near-peer adversaries, the casualties could have been staggering—especially had there been fewer evacuation paths for land and air rescues.

That is why USAMRDC is pursuing a number of promising innovative medical and knowledge products that will enable warfighters to survive bleeding emergencies and other injuries, empowering them to return to battle amid the chaos of war.



### CLEAN HOUSE

In some of the heaviest urban combat that U.S. troops had seen since 1968, Soldiers clear a house in southern Fallujah Nov. 19, 2004, during Operation Al-Fajr. (Photo by 1st Lt. Kimberly Snow, 196th Mobile Public Affairs Detachment)

### THE EVOLVING BATTLEFIELD

For centuries, terrain and civilian population density have influenced the manner in which nations conduct war. During the Vietnam era, the U.S. Army, by necessity, became more adept at fighting in tropical lowlands, hills and densely forested highlands environments. However, given the increased lethality of today's weapons and the emerging threats of near-peer adversaries, conducting battles in dense urban environments comes with many risks.

USAMRDC, based at Fort Detrick, Maryland, continually investigates medical solutions for the evolving battlefield in various areas of biomedical research, including military infectious diseases, combat casualty care, military operational medicine, medical chemical and biological defense, and clinical and rehabilitative medicine.

The guiding concept for battle in the 2025-2050 time frame is multidomain operations. It describes how the U.S. Army, as part of a joint force, can counter and defeat near-peer adversaries across the operational environment: air, land, sea, cyberspace and space.

Finding pathways to success means understanding the elements at stake in setting goals, managing assets, and equipping and empowering personnel. In "Multi-Domain Battle: Combined Arms for the 21st Century," strategists suggest that U.S. forces must adapt to near-peer adversaries capable of achieving their objectives below the threshold of massive armed conflict.

With that in mind, DOD continually explores game-changing concepts, technologies, equipment and protocols that bolster the medical prospects for injured warfighters. For example, DOD envisions that many future military engagements may require

## Our mission as health care providers is to protect and sustain our warfighters—our greatest national asset.

small, mobile, expeditionary forces capable of self-sustainment for significant periods in deep areas far removed from U.S. military or medical support. That means elevating prolonged field care to new heights to overcome a host of battlefield challenges, such as severe bleeding, airway compromise, burns, crushing injuries and traumatic brain injuries.

### TIER 2 TACTICAL COMBAT CASUALTY CARE

At Fort Benning, Georgia, a new standardized way to train combat troops of all services in battlefield casualty care is underway.

Tier 2, which will replace what is currently known as Combat Lifesaver training, draws on the most medically up-to-date lessons learned during the nearly two decades of post-9/11 combat in places like Iraq and Afghanistan, said Lt. Col. Ethan Miles, chairman of the Tier 2/Combat Lifesaver Working Group and medical lead for Fort Benning's Maneuver Center of Excellence.

"The Global War on Terrorism has taught us is that one of the most important things you can do in saving lives is training nonmedical people," Miles emphasized. Tier 2 is one of four parts of what the military calls Tactical Combat Casualty Care.

Tactical Combat Casualty Care, based on a March 2018 DOD directive that a new curriculum be developed for all the armed forces, consists of four levels of skill, all geared to training service members in the

best methods for giving medical care to the wounded in the first critical minutes before they can be taken to a hospital. Those skill levels are:

- Knowledge or overview of combat casualty care.
- Ability to assess the severity of casualties.
- Ability to assess and mitigate massive external hemorrhage.
- Ability to assess airway blockages and clear them.

### BLOOD: KEY TO SUSTAINING WARFIGHTERS

The Combat Casualty Care Research Program (CCCRP), as part of USAMRDC, collaborates with the U.S. Food and Drug Administration (FDA) to find novel approaches for extending the shelf life of blood products and, as a result, preserving the lives of warfighters. Research funded by the Army and conducted by its Institute of Surgical Research and industry partners indicates that freeze-dried plasma and cold stored platelets can provide game-changing advances in the treatment of massive bleeding.

Blood loss decreases circulating volume, oxygen-carrying capacity, clotting factors and platelets. This, in turn, results in shock and ultimately death if not addressed



### EVACUATION

USAMRDC continually investigates medical solutions for the evolving battlefield in various areas of biomedical research, including combat casualty care and military operational medicine. (Photo by Spc. Dominic Trujillo, 115th Mobile Public Affairs Detachment)

## USMRDC is pursuing innovative products that will enable warfighters to survive bleeding emergencies and other injuries.

promptly. The primary advantage of using freeze-dried blood plasma is that it is a stable, dry product that remains effective at room temperature for up to two years, until it is reconstituted with sterile water when ready for use by medical personnel. Unlike fresh frozen plasma, which requires refrigeration at all times, freeze-dried plasma can be stored practically anywhere and transported in backpacks to treat wounded warfighters in the field. Platelets, one of four components found in blood, play a pivotal role in the clotting process by gathering at the site of an injury and sticking to the lining of the injured blood vessel. Cold stored platelets are typically refrigerated at 1 to 6 degrees Celsius, essentially extending the shelf life beyond the 72 hours typical of platelets stored at room temperature.

Recently, the FDA approved a license request submitted through a collaboration of the Army and the South Texas Blood and Tissue Center in San Antonio, permitting the manufacture and distribution of cold stored platelets (up to 14 days) for use in actively bleeding patients when conventional platelet products are unavailable or impractical.

### FRESH WHOLE BLOOD TRANSFUSIONS IN BATTLE

In March 2017, the U.S. Army Materiel Command recognized the 75th Ranger Regiment's Ranger O Low Titer (ROLO) Whole Blood Program as the individual military winner of the annual Army's Greatest Innovation Award. Three years

later, as a result of an accelerated military approval process, ROLO is saving lives on the battlefield.

The program tests all members of a unit or fighting force to determine whether their blood is O-negative. Donors with type O-negative blood have the unique power to help anyone in need of a blood transfusion, regardless of the

recipient's blood type. Red blood cells from O-negative donors can be transfused to anyone, which is especially important in battlefield settings when medics need to quickly administer blood transfusions before blood-typing a casualty for an exact match.

In conjunction with more precise methods of screening donor blood, the ROLO program represents a marked improvement in blood donor programs compared with those in place during World War II, the Korean War and the Vietnam War.

Army officials indicated that two Rangers in Afghanistan survived life-threatening injuries during the summer of 2019 as a result of ROLO. Medics drew blood from

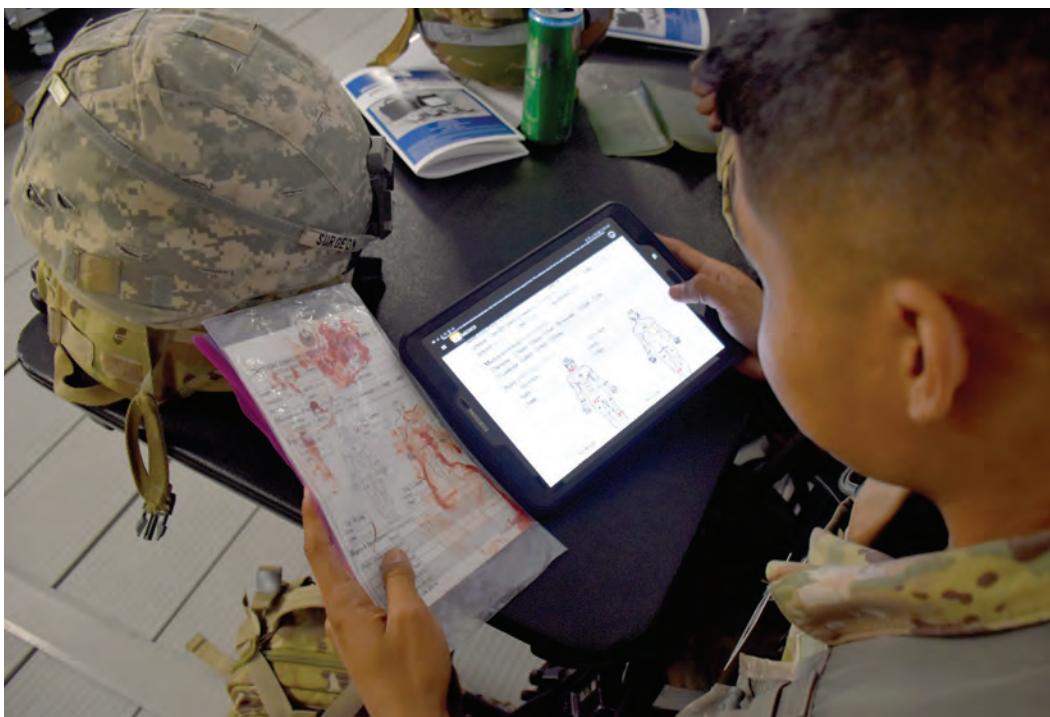

### REAL-TIME MONITORING

MEDHUB connects to multiple wireless patient monitors housed in a medevac vehicle or helicopter, sending the casualty's condition, injury and vital signs in real time and thus reducing the potential for human error in a chaotic battlefield environment. (Photo by Ashley Force, USAMMDA Public Affairs)

volunteers in real-time battle and immediately administered it to the wounded Rangers, amid close gunfire attack by enemy forces. One critically injured Soldier with a hemorrhaging chest wound received 10 units of blood in total, including three from battlefield donations, before being evacuated to a military hospital.

Other concepts that may prove useful in immediate care of battlefield casualties include:

**Lightweight medical backpacks.** DOD is working with several academic research institutions to develop self-contained trauma care systems that fit into a medic bag or rucksack and make it possible to stabilize and transport injured warfighters in remote locations.

**Big data.** Multidisciplinary teams representing medicine, surgery and critical care endeavor to provide real-world data and medical algorithms for roboticists and computer scientists to incorporate in the creation of automated technologies capable of stabilizing medical treatments such as organ support, resuscitation and the administration of pharmaceuticals.

## TRAUMATIC BRAIN INJURIES

According to DOD, in early January, Iranian forces launched more than a dozen ballistic missiles against two military bases in Iraq in response to the U.S. drone strike that killed Maj. Gen. Qassem Soleimani, the commander of Iran's elite Quds Force. In the aftermath, more than 100 troops were treated for traumatic brain injuries (TBIs).

TBI results from a violent blow or jolt to the head. Objects that penetrate brain tissue, such as a bullet or shattered piece of skull, also can cause TBIs.

In a white paper titled "Outcome Trends after U.S. Military Concussive Traumatic Brain Injury," published in the *Journal of Neurotrauma*, researchers indicate that medical care for U.S. military personnel with a combat-related concussive TBI has changed substantially in recent years.

As a result of studying the effects on warfighters injured between 2008 and 2013 in Iraq and Afghanistan, researchers say TBI may be a pervasive, complex and underreported injury.

The Warfighter Brain Health Project Management Office, a component of USAMRDC, drives the development and acquisition of materiel products to aid warfighters suffering from brain injuries and psychological health issues. By collaborating with



## KEEP COLD FOR BEST RESULTS

Spc. Lauren O'Neal, assigned to the 153rd Blood Support Detachment at Bagram Airfield's Craig Joint Theater Hospital, prepares to screen blood for platelets as part of the hospital's new Cold Storage Platelets program. (Photo by Kevin Walston, 10th Mountain Division)

the Military Operational Medicine and Combat Casualty Care Research programs, the U.S. Army Medical Materiel Development Activity and medical research institutions are making inroads into better understanding TBIs and developing protocols and medical solutions to improve outcomes.

## THE EVOLUTION OF THE SUPER-SOLDIER

Many of us have seen Hollywood's interpretation of super-Soldiers in movies like "Iron Man" and "Edge of Tomorrow." Such science fiction has spawned a modern-day arms race to field stronger, faster and more agile warfighters.



### TIER 2 CARE

Tier 2 Tactical Combat Casualty Care will replace what is currently known as Combat Lifesaver training, drawing on the most medically up-to-date lessons learned during the last two decades of post-9/11 combat. At Fort Benning's Medical Simulation Training Center, medics and other experts from across the armed services practice treating "junctional" wounds. (Photo by Markeith Horace, Fort Benning Public Affairs)

According to the RAND Corp., Russia, China and North Korea have each invested heavily in efforts to create more lethal warfighters capable of prevailing in encounters with the United States.

Imagine an otherwise incapacitated warfighter, seemingly unable even to hold a weapon, suddenly empowered to rejoin the fight and protect the unit pending

medical evacuation. It is that type of scenario that strategists and researchers are preparing for as America's near-peer adversaries pursue increasingly lethal weapons and tactics.

For more than 20 years, the Army has explored industrial exoskeleton technologies for potential military applications: enhancing Soldier lethality by promoting

strength and endurance, and lessening the frequency of spinal injuries. As part of that effort, the Defense Advanced Research Projects Agency (DARPA) has funded research in exoskeletal development leading to the creation of the Human Universal Load Carrier, a Lockheed Martin Corp. prototype undergoing further development.

Health care professionals say that of the many risks dismantled Soldiers face in the field, one of the most common is injury from carrying nearly 100 pounds of gear for extended periods, often over rough terrain. DARPA's engineers say, "Heavy loads increase the likelihood of musculoskeletal injury and also exacerbate fatigue, contribute to both acute and chronic injury and impede Soldiers' physical and cognitive abilities to perform mission-oriented tasks."

DARPA envisions combining elements from various projects into a uniform exoskeletal system that nearly every Soldier could wear. The uniform would "provide decisive benefits under real-world conditions," said Lt. Col. Joseph Hitt, DARPA program manager for the Warrior Web.

Leveraging existing exoskeleton technology to help the injured warfighter maintain mobility and combat effectiveness while awaiting evacuation is of high interest to the CCCRP.

Several dozen U.S. companies are seeking to produce exoskeletal systems that strike the right balance of size, weight and freedom of movement.

### SITUATIONAL AWARENESS

According to officials at USAMRDC, the U.S. Army Futures Command's modernization efforts are helping the medical

community to provide better care to wounded Soldiers in medical evacuations from the battlefield.

A key component of improving patient care is a program known as Medical Hands-Free Unified Broadcast (MEDHUB), which allows providers better situational awareness within the battlespace. It relies on Nett Warrior, which is an integrated dismounted leader situational awareness system used during combat operations.

MEDHUB connects to multiple wireless patient monitors housed in a medevac vehicle or helicopter, transmitting the person's condition, injury and vital signs (updated every two minutes) to the receiving medical facility—and inevitably reducing the potential for human error in a chaotic battlefield environment. Awaiting medical facilities can now use a dashboard running on a Mounted Family of Computer Systems to update patient information in real time.

CCCRP researchers believe that MEDHUB vastly accelerates the process of accurately communicating a patient's medical condition throughout the evacuation and transfer process.

### INNOVATIVE CARE

We have seen over the past 20 years a remarkable improvement in survivability following combat injuries. This is attributable largely to our ability to meet the demands of the “golden hour” following a potentially lethal injury, when prompt medical attention can save a life. As we transition our focus to preparing for near-peer or peer conflict, senior DOD leaders insist that the medical community adjust its mindset to adapt to a changing operational environment in which U.S. forces may have to shelter in place for up to 24 hours before medical evacuations occur.

**Given the lethality of today's weapons and the emerging threats of near-peer adversaries, battles in dense urban environments come with many risks.**

The medical community is acutely aware that Russia and China have closed military and technological gaps that once made the U.S. military unsurpassed. Our mission as health care providers is to protect and sustain our warfighters—our greatest national asset.

With that in mind, the CCCRP envisions reducing casualties by as much as 25 percent in future conflicts by driving innovative medical research that yields tangible results for warfighters. Our mission is critical: not only to save lives, but also to bolster our prospects for success against adversaries whose vision for the world may threaten peace, freedom and security.

*For more information on USAMRDC, go to <https://mrdc.amedd.army.mil> or contact Chelsea Bauckman, USAMRDC deputy public affairs officer, at [chelsea.b.bauckman.civ@mail.mil](mailto:chelsea.b.bauckman.civ@mail.mil). For more information on the CCCRP, go to <https://ccc.amedd.army.mil/Pages/default.aspx>.*

---

*JAMES A. BLACK is the communications manager for the CCCRP, Fort Detrick, Maryland. Before assuming his current role, he spent nearly a decade as a broadcast journalist, earning two Emmy Awards. He has an M.A. in journalism from the University of California, Berkeley, and a B.A. in political science from Tufts University.*

*LT. COL. DAVID S. JOHNSTON is deputy director of the CCCRP. He holds a Ph.D. in biochemistry from Vanderbilt University, an M.S. in strategic intelligence from the National Intelligence University and a B.S. in biology from Bryan College. Previously he served as deputy commander and director of business operations for the U.S. Army Medical Materiel Development Activity, a subordinate command of USAMRDC.*

*COL. MICHAEL R. DAVIS, M.D., FACS is director of the CCCRP, where his chief responsibility is to oversee the mid- and long-term development of materiel and knowledge products to close capability gaps in military trauma care. He also serves as professor of surgery at the Uniformed Services University, Bethesda, Maryland. Davis received his M.D. from the Uniformed Services University and a B.A. with honors in physiology and cell biology from the University of California, Santa Barbara. He completed his general surgery residency at the University of Texas Health Science Center, San Antonio, and Wilford Hall Medical Center, Lackland Air Force Base, Texas. His research interests include trauma, critical care and reconstructive transplantation.*

# NEW HORIZONS

Future mega satellite constellations to power Army network modernization.

*by John Anglin, Seth Spoenlein and Amy Walker*

**T**he Army's tactical network modernization strategy will enable a future force that can leverage a network that is vastly more robust, mobile and resilient than it is today. In line with this strategy, the Army is laying the foundation for its future network now, so it can take full advantage of emerging technologies expected to make major impacts when they become available. These enhancements include new capability provided by commercial and military space technologies, such as low Earth orbit (LEO) mega-constellations and medium Earth orbit (MEO) and geostationary high-throughput satellites.

The Army is working across its acquisition, modernization, and research and development communities, joint partners and industry to experiment with these evolving technologies and better understand how they could fuel the network of the future. The Program Executive Office for Command, Control and Communications – Tactical (PEO C3T), the Network Cross-Functional Team (CFT) at the U.S. Army Futures Command, and the U.S. Army Combat Capabilities Development Command (CCDC) C5ISR Center are working closely with industry to build a focused road map and test plan that will allow emerging satellite communications capability to be run through its paces in training and exercises over the next couple of years. These events will inform Army decisions on how innovative technologies could best integrate into the greater network.

## **ONE NETWORK, MULTIPLE SOLUTIONS**

The Army's current satellite capability provides at-the-halt and on-the-move, beyond-line-of-sight network communications to Soldiers dispersed over large regions in remote and challenging terrain. The service leverages a mix of commercial and military satellites in the Earth's geosynchronous orbit. The Army is reevaluating its satellite communications architecture to incorporate both military and commercial solutions across geosynchronous Earth orbit (GEO), MEO and LEO constellations. This diversity would allow for optimizing the best solution set while making the network more robust.

So what's the physical difference between LEO, MEO and GEO satellites? LEO satellites orbit between 90 and 1,200 miles from the Earth's surface; MEO satellites orbit from 1,200 to 22,000 miles from Earth; and large GEO satellites orbit farthest away at 22,000 miles plus. MEO and LEO constellations require more satellites than GEO to achieve the required coverage. MEO constellations will typically require tens of satellites, where LEO requires hundreds and even thousands of satellites orbiting the Earth. GEO satellites appear stationary from a point on the Earth's surface, whereas LEO and MEO move across the sky and require additional tracking and handover capability between satellites.

Each solution has its own strengths and weaknesses. There will not be a final one-size-fits-all solution—different threats





### EMERGING CAPABILITIES

In January, the PEO C3T, Network CFT and the CCDC C5ISR team concluded the initial phases of medium Earth orbit satellite testing with prototype ground satellite terminals, at the C5ISR Center's Joint Satellite Communications Engineering Center. The Army, in collaboration with industry, is developing a road map for testing emerging satellite communications capability in training and exercises, to inform Army decisions on integrating innovative technologies into the greater network. (Photos by Amy Walker, PEO C3T Public Affairs)

may require different solutions. Instead, the Army will capitalize on the strengths of all of these evolving capabilities to provide commanders and signal officers with multiple network communication capabilities and signal path options to optimally support their missions.

### MORE BANDWIDTH, LESS LATENCY

LEO and MEO satellite communication capabilities are expected to provide huge increases in network bandwidth while significantly reducing latency, the time it takes for data to travel from the source to the destination. Both are must-haves for many of the Army's network modernization efforts. When compared with current GEO solutions, the anticipated deployment of mega-constellations operating in LEO could provide a 100 times increase in bandwidth and a 10 times reduction in latency, while providing network communication services to a greater density of users supporting a mission. MEO bandwidth increases will be slightly less, but significantly more than current GEO capability provides. Bottom line: These improvements will enable more data to be sent faster to a larger number of users.

The anticipated proliferation of LEO and MEO satellite capabilities by commercial industry provides the potential to significantly increase the communications capacity across the Army. It would deliver expeditionary, mobile, beyond-line-of-sight communications with increased bandwidth and low latency to better enable the Army's mission command systems.

High-throughput systems in GEO, LEO and MEO solutions are also expected to reduce stress on overburdened military GEO satellite capability and provide more connection options for increased network resiliency. LEO satellite constellations will contain numerous small satellites at a much lower altitude, with the natural physical resiliency that comes with having so many satellites. The signals don't have to travel as far to get to the satellite, so the latency is significantly reduced, which will improve the performance of the network, especially for real-time applications.

Among many potential applications, LEO and MEO capabilities are expected to enhance the Army's ability to aggregate data supporting artificial intelligence and to leverage edge cloud services. Edge cloud services enable Soldiers to gain quick access to data and software through multiple small data centers located close to the user, which reduces bandwidth usage and latency compared with accessing large, distant data centers. With successful inter-satellite links, these solutions could also enable the Army to put more complex network functions and mission support capabilities in safe sanctuaries, pulling complexity out of tactical echelons and putting it where it can be maintained effectively with more resources in a less contested environment.

Of significant importance, the Army plans to use future LEO and MEO solutions to support Joint All Domain Command and Control (JADC2)—a major effort that will leverage capabilities across all domains and mission partners to achieve battlefield

advantage. In support of JADC2, the Army plans to deliver network transport and data management solutions to enable the flow of critical situational awareness and sensor data, and thus connect sensors (such as aircraft, radar and Soldier-wearable devices) to shooter (the weapon systems that attack targets) all the way down to the dismounted Soldier. New LEO and MEO systems could deliver the needed improvements in network latency, capacity and resiliency to enable the convergence of mission command, fires, sustainment and intelligence data, and to push all of that aggregated data from the Army’s common operating environment to the JADC2 network.

**PHASED DEPLOYMENT**

As part of its network modernization strategy, the Army is delivering phased capability enhancements on a two-year basis, beginning with Capability Set 21 in fiscal year 2021 to select infantry formations, and then including Stryker and armored formations beginning with Capability Set 23 and beyond. The Army will build on lessons learned from the development and fielding of each capability set, including work being done with new and evolving satellite capabilities.

The Army plans to leverage a mix of multiple military and commercial satellite constellations to support its overall satellite network communications architecture. The service will continue to leverage GEO satellites currently in use, and add capability to leverage emerging constellations. These include commercial LEO and MEO mega-constellations; commercial high-throughput satellites; and the extremely resilient Protected Tactical Satellite communications military GEO satellite system in development by the Air Force.

This kind of diversity through multiple signal paths provides desirable network redundancy; however, it also increases overall network complexity. Research and development investments, as well as engagements with industry, are underway to address these and other challenges. Considerations could include the exploration of new processes and business methods, such as following a managed service model.

While the Army will leverage spacecraft developed by other government agencies and commercial providers—and not build its own satellite communications space network—challenges exist with the

integration of the satellite communications components into the terrestrial network, as well as providing the ground antennas that could support ruggedized on-the-move network capabilities. Just how to integrate some of these solutions with Soldiers and onto platforms is being explored.

The Army’s multi-constellation strategy will require different ground terminals and eventually integrated multifunctional ground terminals. Today, each GEO, MEO and LEO solution requires its own dedicated antenna, which increases size, weight and power requirements. The Army is exploring integrated terminals that support multi-orbits and frequency bands, while leveraging the significant component cost reduction that is anticipated as a result of the commercial deployments. Initially, for Capability Set 23, the Army envisions using a single frequency-band ground terminal supporting one specific constellation. Integrated terminals capable of supporting multiple bands and constellations will eventually be developed for future capability sets.

**EXPERIMENTATION EFFORTS**

The Army’s initial experimentation is focused on testing commercial services



ORBIT TYPES	ALTITUDE (miles)
● Low earth orbit	Up to approx. 1,200
● Medium earth orbit	Approx. 1,200 - 22,000
● Geosynchronous earth orbit	Approx. 22,000

## The Army is working across its acquisition, modernization, and research and development communities, joint partners and industry to experiment with these evolving technologies.

while evaluating various ground antenna solutions. In January, PEO C3T, the Network CFT and the CCDC team concluded the initial phases of MEO testing at the C5ISR Center's Joint Satellite Communications Engineering Center at Aberdeen Proving Ground, Maryland. The experimentation characterized emerging MEO capability to see how the Army's tactical network performed over the commercial MEO constellation, and it provided MEO constellation and terminal solution performance data and lessons learned to help inform capability set design decisions. Because of the COVID-19 outbreak, MEO testing efforts were temporarily put on hold and will resume when Army leadership delivers that guidance.

### ◀ ORBITAL OPTIONS

For optimal capability to support its network, the Army is reevaluating its satellite communications architecture. The intent is to incorporate both military and commercial solutions in a variety of constellations and orbits, and to leverage spacecraft developed by other government agencies and commercial providers. (U.S. Army graphic)

The CCDC C5ISR Center is leading and pulling together the LEO test and experimentation efforts, with PEO C3T and the Network CFT monitoring these efforts as they evolve. The focus is on understanding technical operation and system requirements of specific LEO mega-constellation systems and analyzing ground terminal technology. CCDC C5ISR is working numerous LEO cooperative research and development agreements with multiple companies to test their services and antennas. Experimentation time frames will be driven by terminal availability and constellation coverage. CCDC C5ISR has also partnered with the Air Force Strategic Development Planning and Experimentation Office to award experimentation contracts for emerging ground terminals operating over LEO, MEO and GEO constellations.

### CONCLUSION

Winning tomorrow's wars against peer and near-peer adversaries requires U.S. forces to stay ahead in the technology race. Innovations in artificial intelligence, cloud computing and networking on the move will require significant enhancements in satellite communications transport, which could be realized through LEO, MEO and high-throughput GEO satellite systems. Smart planning and forward thinking will be essential to ensuring mission success on tomorrow's multidomain battlefield.

For more information, go to <http://peoc3t.army.mil/c3t/>; or contact the PEO C3T Public Affairs Office at 443-395-6489 or [usarmy.APG.peo-c3t.mbx.pao-peoc3t@mail.mil](mailto:usarmy.APG.peo-c3t.mbx.pao-peoc3t@mail.mil).

*JOHN ANGLIN is the Technical Management Division chief for Project Manager Tactical Network within PEO C3T. He has over 20 years of experience, as both a civilian and a Soldier, in Army tactical network communications. He has an M.S. in systems engineering from Johns Hopkins University and a B.S. in information technology concentration from Colorado Technical University. He is a member of the Army Acquisition Corps (AAC) and is Level III certified in engineering.*

*SETH SPOENLEIN is the senior scientific technical manager for Integrated Networks within the U.S. Army Futures Command's CCDC C5ISR Center. He is the senior technical adviser supporting the Network Cross-Functional Team. He holds a Master of Engineering in systems engineering from Stevens Institute of Technology and a B.S. in computer engineering from Lehigh University. He is a member of the AAC and is Level III certified in engineering.*

*AMY WALKER has been the public affairs lead at Project Manager (PM) Tactical Network for the last 10 years, and was the public affairs lead at PEO C3T for the previous two. She has covered a majority of the Army's major tactical network transport modernization efforts, including Army, joint and coalition fielding and training events worldwide. She holds a B.A. in psychology, with emphasis in marketing and English, from the College of New Jersey. She is a frequent contributor to the Army AL&T; her byline appeared on "Rapid Networking" in the Winter 2020 issue.*

## IN THE FEEDBACK LOOP

At a Soldier touch point session at Fort Sill, Oklahoma, in February, Soldiers from the 75th and 428th Field Artillery Brigades used an early engineering release of AFATDS 7.0 software to perform typical fire mission processing tasks. Sessions such as this are part of the iterative design process. (Photo by Pam Savage-Knepshield, U.S. Army Combat Capabilities Development Command Armaments Center)

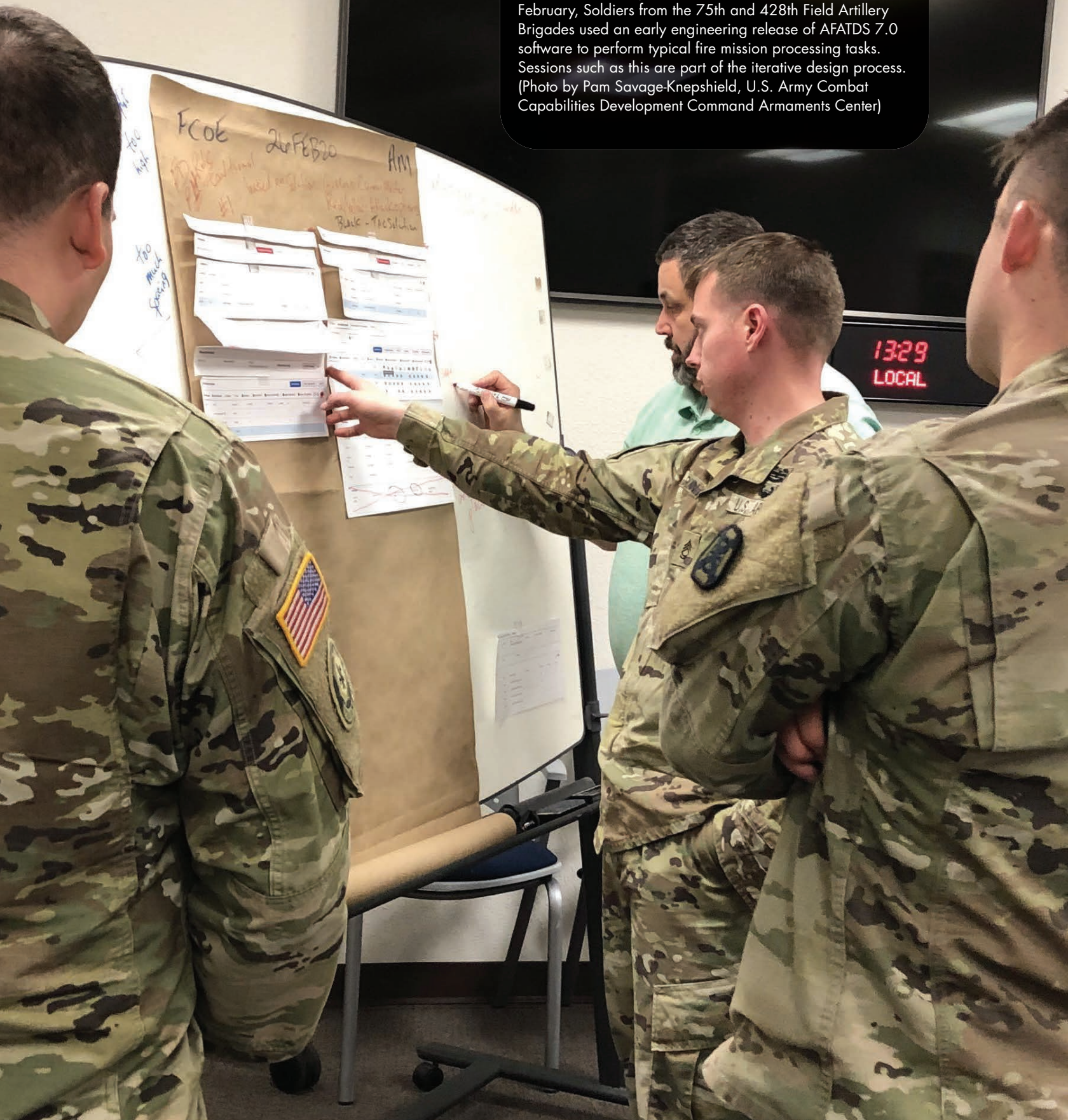

# TACTICAL SOFTWARE 'SPRINTS' FORWARD

PEO C3T adopts Agile software development best practices to deliver better tactical software to Soldiers, improved by early and frequent changes reflecting their feedback.

*by Lt. Col. Shawn Chu-Quinn, Richard Boodhoo, George Senger and Jeffrey Kuderna*

Recent modernization throughout the Army has spawned several fast-moving initiatives designed to accelerate the timeline for developing and fielding tactical network and associated software-provided capabilities. Among these buzzword-driven efforts is Agile software development. Unlike traditional software development methods, in which several months or years can be spent on a product that is hopefully still relevant by the time it's fielded to Soldiers, Agile focuses on rapid, iterative releases while frequently engaging with users to determine real-world needs.

Long an industry practice, Agile continues to gain popularity within DOD. Agile breaks down the development process into small, easily managed, time-boxed iterations with set goals called "sprints." Sprints are typically conducted every two to three weeks, depending on level of complexity. They include sprint planning, held at the beginning of each sprint cycle; sprint execution, which includes short daily meetings to identify accomplishments, plans and known obstacles; and a sprint retrospective at the end of each sprint cycle.

More than ever, the Army is putting a strong emphasis on the user collaboration function of Agile sometimes referred to as development and operations, or DevOps. By placing developers side by side with Soldiers and commanders in operational units,

technology concepts and solutions can be evaluated earlier and more frequently, with feedback collected in real time to refine or generate new requirements as needed.

Collaborative developmental efforts are also providing Soldiers with a sense of empowerment, knowing they are directly influencing the direction of future capabilities.

Over the past four years, the Army’s Program Executive Office for Command, Control and Communications – Tactical (PEO C3T) has adopted Agile software

development best practices, values and principles within several of its programs to deliver next-generation capabilities. The Agile development process enables program offices to incrementally provide commanders and staff functions with capabilities that are continuously improved from current baselines, and allows for programs to receive real-time feedback.

### MAKING IT WORK

PEO C3T’s Project Manager for Mission Command (PM MC) uses Agile software practices for its Command Post Computing Environment (CPCE), which is the

primary computing environment under the Army’s Common Operating Environment (COE). The COE provides an easy-to-use common operational picture through a single mission-command suite and server hardware operated and maintained by Soldiers.

PM MC enacted Agile software development practices for CPCE early on when it struck a government-to-government agreement with the Weapons and Software Engineering Center of the U.S. Army Combat Capabilities Development Command Armaments Center to act as its lead systems integrator. In doing so, the agreement set the conditions for maintaining Agile practices throughout the software development life cycle to ensure delivery of Soldier-informed capabilities in a timely and cost-effective manner. To do this, PM MC enlisted the Scaled Agile Framework (SAFe) based on the complexity of the CPCE program.

The task was to develop modernized and more intuitive versions of capabilities provided by legacy mission-command systems, while integrating warfighter feedback via Agile software development methods. The first step of the SAFe implementation road map was workforce education.

Back in 2015, one of the major challenges encountered with DOD acquisition was that acquisition processes were specifically tailored to a waterfall software development cycle. Software programs of record were expected to have very detailed requirement and design documents established well before software development could begin. This waterfall methodology did not align with the changing environment and times, in which asymmetric warfare and enemies who rapidly adjust their tactics are more commonplace.



### CAPABILITIES, DELIVERED

Soldiers from the 1st Cavalry Division train on upgraded CPCE software and hardware during fielding by PM MC in February at Grafenwoehr Training Area, Germany. PM MC has adopted Agile software development practices for the CPCE, incorporating user feedback in each iteration. (Photo by Justin Eimers, PEO C3T Public Affairs)



## UNIT COHESION

Soldiers from PEO C3T's PM Tactical Radios attend an internal demonstration of the Black Sails application in February 2019 at Aberdeen Proving Ground, Maryland. Black Sails enables separate units operating over software-defined, multiple-channel radios to join a common network, a move known as "unit task reorganization." (Photo by Kathryn Bailey, PEO C3T)

The Army's technology and mission-command software needed to adapt to the evolving threats, and Agile processes would allow for a more continuous software release when compared with traditional software development processes, which could take up to six years as developers

aimed to define what they hoped were perfect requirements.

While SAFe training for the workforce was underway, the team conducted analyses to determine where and how best to apply these newly learned Agile

practices. Certain acquisition processes, such as requirements definition by the Army capability manager and accreditation at Army interoperability certification events, were outside the jurisdiction of the Project Manager for Mission Command. The team subsequently developed a strategy to blend Agile software development life cycle methodologies with the existing acquisition process.

Through this hybrid strategy, PM MC has been able to release cost-effective, robust mission-command software more frequently to meet the threat, while maintaining the approved acquisition processes. While requirement-definition packages and capability drop documents would serve as the basis for the design and development of a given software release, warfighter feedback from DevOps exercises would also be prioritized by the PM. Developers and integrators quickly realized that DevOps exercises themselves would serve as an opportunity to familiarize the Soldier with the software, while identifying any potential issues before major events such as the Army interoperability certification.

In addition to receiving direct Soldier feedback, PM MC's Agile scrum teams have an operational subject matter expert, usually a retired officer, warrant officer or noncommissioned officer, integrated into the team to assist developers in designing capabilities with the end user in mind. The team also conducts sprint demonstrations every three weeks, which are then shared with the trainers, schoolhouses and representative users to obtain feedback.

## MODERNIZED FIRE SUPPORT

Another program leveraging Agile software development best practices within PM MC is the Advanced Field Artillery Tactical Data System fire support system.

FIGURE 1

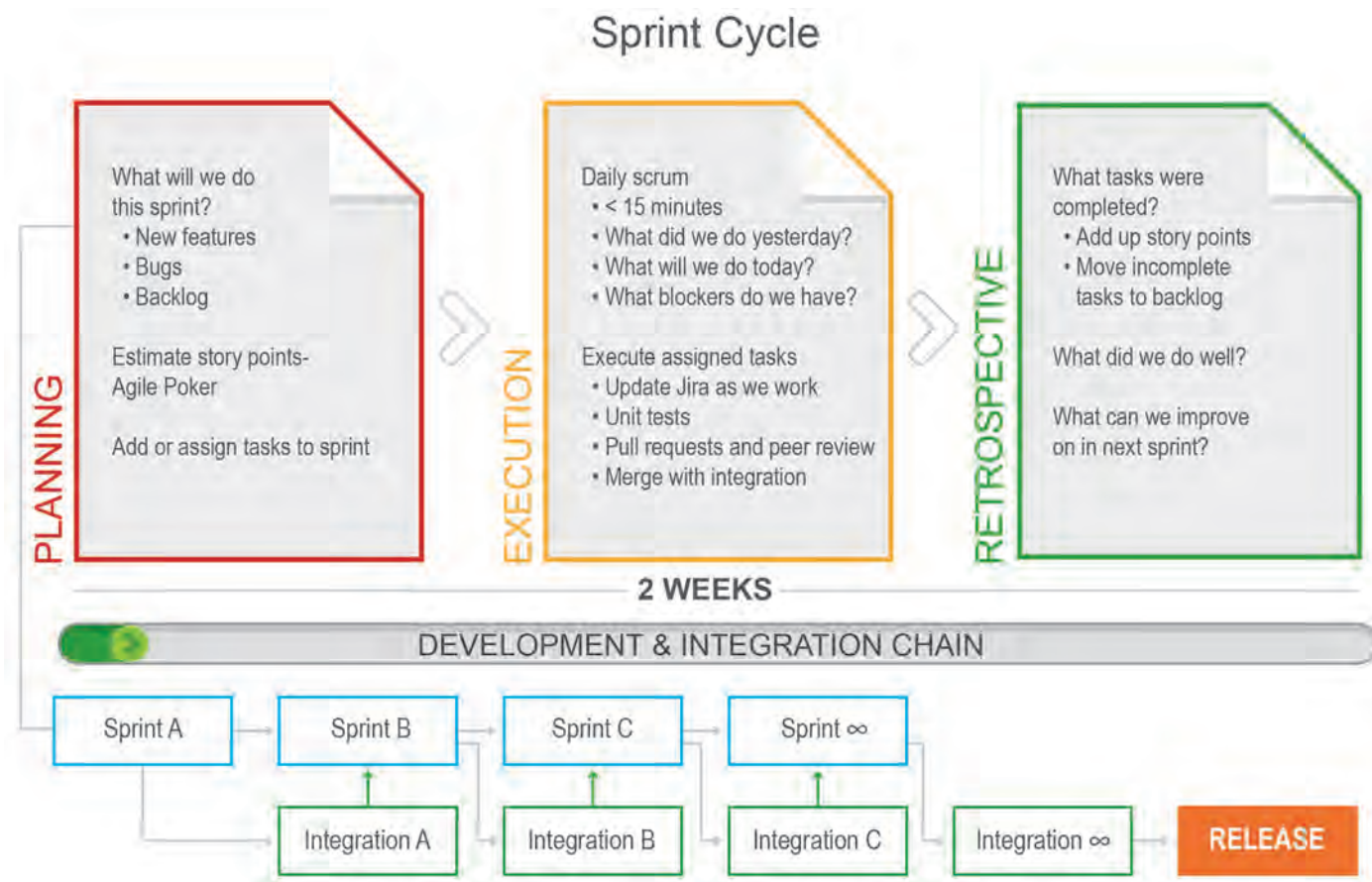

**ANATOMY OF AGILE**

The Black Sails Agile scrum framework inserts integration testing and feedback into its two-week sprints to ensure continuous course correction throughout the software development process. (Graphic by Black Sails development team)

The system provides fully automated support for planning, coordinating, controlling and executing fires and effects. It is the primary command-and-control system for Long-Range Precision Fires Cross-Functional Team initiatives.

The most recent version under development involves a complete rewrite of the software from a stand-alone application to a web-based solution as part of the software modernization effort. Working with industry, developers are mixing Agile best

practices with traditional software development practices. This drives functionality through requirements analysis, architecture and design, and implementation and testing for systems in which uninterrupted functionality, such as fire support, is critical to warfighter safety.

However, based on the architecture team’s interpretation of the requirements, the team has been able to tailor the Agile process to fit its needs; specifically to develop software that provides a technical

fire-direction capability for battery-size fire support units.

Developers incorporated a usability test with Soldiers during an early engineering release to pinpoint what was working well and what was not, thus identifying enhancements that would make using the system more effective. The one area over which fire-support personnel have expressed concern was the user interface design. Because of the ongoing DevOps with incremental experimentation,



developers are able to continue to refine the design, often within the next sprint depending on the scope of changes.

The process also provides the team with a framework to bake in safety, cyber and performance requirements throughout development by assessing vulnerabilities and code issues and correcting them before they become problematic. Automation tooling and code generation have also contributed significantly to the Agile process.

### **SOFTWARE-DEFINED RADIOS EPITOMIZE AGILE**

The Army's tactical network modernization effort includes new software-defined radios, which are radios that can be configured to any frequency by way of software versus having set hardware components. PEO C3T's Project Manager Tactical Radios team is using a modified Agile-Scrum framework to develop a critical capability called Black Sails, which simplifies and speeds up the ability for separate units or coalition forces to join one network to complete a common mission.

Traditionally, the process to connect all of the radios onto a common network would take anywhere from four to six hours because the units' signal officers would have to manually configure each radio. Black Sails has shortened the time to 30-40 minutes by connecting software-defined radios to end-user devices via a network broadcast similar to Wi-Fi.

Like CPCE and the Advanced Field Artillery Tactical Data System, the Black Sails project incorporates Agile with sprints to help manage the development process. However, because Black Sails includes several applications managed across many programs—applications that must, in turn, be integrated into

multiple hardware platforms—the Black Sails development team added a parallel process called the integration chain. (See Figure 1, Page 86.)

## **PM Mission Command has released cost-effective, robust mission-command software more frequently to meet the threat, while maintaining the approved acquisition processes.**

Using this process, the team is able to conduct two-week sprints while also performing integration testing, which provides them the opportunity to continuously identify and correct issues with integration as part of the entire development cycle.

### **CONCLUSION**

As part of its modernization effort, the Army continues to use Agile software development processes to design and deliver cutting-edge capabilities. Iterative, collaborative software development—with a quick cadence of small releases—ensures that the system will be relevant when fielding. With the exponential pace of technology, modernization can occur only if developers have the flexibility to insert the latest software into Soldier solutions. Agile development provides that flexibility.

For more information, go to <http://peoc3t.army.mil>, or contact the PEO C3T Public Affairs Office at 443-395-6489 or [usarmy.APG.peo-c3t.mbx.pao-peoc3t@mail.mil](mailto:usarmy.APG.peo-c3t.mbx.pao-peoc3t@mail.mil).

*LT. COL. SHAWN CHU-QUINN is the Product Manager for PM MC's Tactical Mission Command. She holds an M.P.A. in national security affairs from Troy University, an M.S. in modeling and simulation from the University of Central Florida and a B.S. in environmental science from Creighton University. She is Level III certified in program management and Level II certified in engineering.*

*RICHARD BOODHOO is the AFATDS 7.0 chief engineer under PM MC. He holds an M.S. in software engineering from Stevens Institute of Technology and a B.S. in computer science from Florida Polytechnic University. He is Level III certified in production, quality and manufacturing and Level II certified in engineering.*

*GEORGE SENGER is a computer scientist serving as the software and services assistant product manager for PEO C3T's Product Manager Waveforms and is the lead engineer for Project Black Sails. He holds an M.S. in computer science from Montclair State University and a B.A. in communications from William Patterson College. He is Level III certified in engineering.*

*JEFFREY KUDERNA is the CPCE project lead for the Tactical Effects, Protection and Interactive Technologies Directorate, Weapons and Software Engineering Center of the U.S. Army Combat Capabilities Development Command Armaments Center. He is also lead systems integrator to the Product Manager Tactical Mission Command. He holds an M.S. in information systems and technology management from the University of Delaware and a B.S. in biomedical engineering from the University of Miami. He is Level III certified in engineering.*



### AN AGILE SYSTEM

Chief Warrant Officer Gabriel Garcia and Spc. Edward Bolton during the third iteration of training for the Deployable Defensive Cyberspace Operations System – Modular at the Georgia Cyber Center, in Augusta, Georgia. The system is agile; it can be deployed in different flexible configurations and host tools for defensive measures. (Photo by the author)

# TRAINING TO DELIVERY: CYBERSPACE WARFARE

Defensive Cyber Operations, Cyber Platforms and Systems creates a modular, carry-on-size cyberspace defense system.

*by Jennifer Sevier*

**T**oday's technology is changing rapidly, and the Project Manager for Defensive Cyber Operations (DCO) ensures that the U.S. Army's cyber defenders are equipped for the fight against all cyber threats worldwide. In response to the threat, the U.S. Army began identifying specific needs for a deployable cyber capability to defend against and mitigate threats from cyber enemies. The solution needed to be armed with state-of-the-art defense tools and have the ability to control, monitor and forensically evaluate who is attacking, determine why and identify what they are after.

In March 2018, the Product Manager for Cyber Platforms and Systems, within PM DCO at the Program Executive Office for Enterprise Information Systems, established a program of record for the Deployable Defensive Cyberspace Operations System. The requirement was to build a configurable hardware kit that could be easily transported by aircraft and other means of transportation. It also needed to be armed with the ability to tap into a network and host tools for defensive measures.

Several factors are considered when acquiring and developing hardware and software prototypes. "Our armed forces need to remain ahead of the adversary by acquiring adaptive platforms and innovative defensive cyberspace tools, ultimately enabling incident response," said Kyle Tucker, acting assistant product manager for Cyber Platforms and Systems.

The team needs to be current and remain dexterous when determining how much internal computer storage and memory these systems will need in order to defend our nation against cyber threats. There was also an additional requirement to have adaptive platforms and system tools, enabling rapid incident response. The solution generated from Cyber Platforms and Systems has a direct sharing ability and provides current tools for our cyber forces.

## **PROTOTYPE EVOLUTION**

Developing a deployable system with the required ability to tap into a network and host attack response tools was no easy feat. Requirements change continuously and rapidly. To keep pace with fluctuations in technology and current threats, many obstacles had to be overcome in a short amount of time. Although the first several prototypes were extremely

rugged, the system was large and cumbersome. At least two men were needed to transport the system, and it had a shortage of computation speed and internal system storage.

With continuous prototype iterations, the system successively came closer to the desired solution. The speed at which the team adapted and moved into the next phases of prototyping is their most critical accomplishment. Cyber Platforms and Systems has been able to award new contracts, prototype the requirements, complete the user assessments and train the cyber defenders within seven months—a critical ability for fielding to Soldiers. The normal acquisition process can take years, and the team accomplished the mission in a fraction of the time with an innovative, agile solution, significantly reducing the acquisition time.

After several more iterations, the fifth prototype now serves as the production version. This design is modular and allows for adaptation based on mission requirements. The system is also scalable, with reduced size and weight allowing greater flexibility to the Soldier.

“We went from a large and bulky prototype in March 2019 to an airline carry-on before the end of November. We were able to get



### CHOOSE YOUR OWN CONFIGURATION

This is an example of multiple components that are adaptable on the Defensive Cyberspace Operations System – Modular. The user can choose the configuration needed for each mission. (Photo courtesy of Sealing Technologies Inc.)

the kit into the hands of our cyber Soldiers in about six months,” said Lt. Col. Michael Lind, the product manager for Cyber Platforms and Systems.

The modular system has the ability to adjust to Soldiers’ needs and be deployed in different, flexible configurations, including adaptable host tools and physical cases. The result of these efforts was a cost savings of \$40 million a year in shipping and travel expenses. Each mission is different, and the system enables the Soldier to adapt to evolving threats.

### NEW EQUIPMENT TRAINING

In November 2019, system training began for the cyber defenders. In less than a month, the Cyber Platforms and Systems team completed various training courses with more than 50 students. The team will continue training the defenders over the next several years as technology and new requirements emerge.

During these training exercises, the cyber defenders learn how to use the software and hardware properly. They also learn how to use the system in different environments and how to respond to current and future threats. These advanced skills allow the cyber defenders to take control of the U.S. Army networks and our cybersecurity response posture to accomplish the mission.

In February 2020, another iteration of training for the Deployable Defensive Cyberspace Operations System – Modular occurred at the Georgia Cyber Center in Augusta, Georgia. The students were excited and ready for the fight. “We are now able to accomplish



### LEARNING THE NEW SYSTEM

Sgt. Kojo Boateng participates in the third iteration of training for the Deployable Defensive Cyberspace Operations System – Modular at the Georgia Cyber Center in Augusta. (Photo by the author)



### PROTOTYPE PROGRESSION

Kyle Tucker, acting assistant product manager for Cyber Platforms and Systems, shows the size and weight reduction from earlier prototypes of the Deployable Defensive Cyberspace Operations System to Maj. Gen. John H. Phillips, commanding general of the 335th Signal Command (Theater). (Photo by the author)

cybersecurity for our nation that we have never been able to before. We need to secure our networks and data. There is nothing more important,” said Chief Warrant Officer Gabriel Garcia, U.S. Army Cyber Command.

In addition to training the Soldiers, the information collected during these training exercises is critical for refining the system and adapting new technology to meet the evolving mission requirements. Training continues to improve with each iteration and will give the cyber defenders the experience needed to proactively respond to cyber threats on U.S. Army networks.

### CONCLUSION

In April, Cyber Platforms and Systems delivered several Deployable Defensive Cyberspace Operations System – Modular kits to the cyber defenders despite the COVID-19 pandemic. The team used a commercial shipping company to deliver the kits, mitigating exposure and using

minimal personnel to complete mission-essential duties. All operations regarding new deliveries were conducted in a virtual operational capacity.

The modular kit offers the most advanced resources needed to host virtualized tools, and the ability to integrate with mission partner networks. It is ready to perform on any network in any environment from moderate to austere. This system provides the foundation for which cyberspace tools can be integrated and new solutions implemented. The tools and hardware acquired by Cyber Platforms and Systems enhance maneuverability in defensive cyber operations, thus enabling future warriors to complete their missions successfully.

Deployable Defensive Cyberspace Operations System – Modular kits are currently fielded through an Armory, a capability designed to act as a library in order to configure and check out the hardware and tools solutions. The Armory also coordinates inventory, manages hardware and

software updates, patches and licensing, and facilitates training. To date, Cyber Platforms and Systems has delivered numerous deployable systems in less than a year, and will provide the cyber defenders several more by fiscal year 2022.

With this system and the tools Cyber Platforms and Systems provides, cyber defenders are able to mitigate cyberspace attacks by executing countermeasures, allowing them to outmaneuver the adversary and achieve mission assurance.

*For more information, go to <https://www.eis.army.mil/mission-areas/defensive-cyber>.*

*JENNIFER SEVIER provides strategic communication support to Defensive Cyber Operations at Fort Belvoir, Virginia, for Octo Consulting. She has 19 years of communication and marketing experience supporting public and private sector communities.*



## LT. COL. THERESA ELLISON

### COMMAND/ORGANIZATION:

U.S. Army Combat Capabilities Development Command

### TITLE:

Director, Combat Capabilities Development Command, Atlantic region

### YEARS OF SERVICE IN WORKFORCE: 14

### YEARS OF MILITARY SERVICE: 23

### DAWIA CERTIFICATIONS:

Level III in program management, contracting and international acquisitions

### EDUCATION:

Currently pursuing a Ph.D. in public policy and administration, Walden University; M.S. in management of acquisition and contracting, Florida Institute of Technology; M.A. in public administration and public management, Troy State University; B.A. in governmental administration, Christopher Newport University

### AWARDS:

Bronze Star Medal, Purple Heart, Defense Meritorious Service Medal (2nd award), Meritorious Service Medal (5th award), Joint Service Commendation Medal (2nd award), Army Commendation Medal (4th award), Joint Service Achievement Medal, Army Achievement Medal (3rd award), Joint Meritorious Unit Award (2nd award), Army Good Conduct Medal, National Defense Service Medal, Armed Forces Expeditionary Medal, Iraq Campaign Medal, Global War on Terrorism Expeditionary Medal (3rd award), Global War on Terrorism Service Medal (2nd award), Korea Defense Service Medal, Military Outstanding Volunteer Service Medal, Non-Commissioned Officer Professional Development Ribbon, Army Service Ribbon, Overseas Service Ribbon (4th award), NATO Medal, Army Staff Identification Badge, Combat Action Badge

## FROM ART SCHOOL TO 'TEAM ARMY'

**L**t. Col. Theresa Ellison never planned to stay in the Army past her first contract commitment—she dreamed of an arts career in England or France—but over the course of her 23-year career, she discovered that she had found a home in the Army. “I always planned to move to Paris to attend culinary school or to return to art school to design beautiful shoes in London,” she said. While that may seem quite a departure from her current work in the Army, Ellison has found a great combination in her work, her interests and in traveling the world.

“The Army is family,” she said. “I tell fellow warriors and subordinates to make good choices and form long-lasting friendships. Before everything else, we are on Team Army.” A longtime member of the Army Acquisition Workforce (AAW), Ellison feels she has grown in her 23 years of military service. “I gained a depth in knowledge, character, empathy and emotional maturity within the ranks,” she said. “My experiences changed me for the better.” Those experiences add context and help her keep perspective in her day-to-day work.

“Perspective makes a difference,” she added. “Most of the time, this philosophy has helped me empathize and have more compassion.” Maintaining perspective is especially important in Ellison’s position as director of the Atlantic region Field Assistance in Science and Technology team, where she works with stakeholders across the Army to deliver critical solutions to Soldiers.

“I am tasked to provide reach-back capability into the Combat Capabilities Development Command (CCDC) and the U.S. Army Futures Command,” she explained. “We leverage expertise and capability in support of USAREUR’s [U.S. Army Europe] operational missions and Theater Security Cooperation objectives.” CCDC works closely with allies and partners to ensure U.S. warfighters have access to the world’s best technologies. It coordinates with foreign governments, industry and academia, and provides robust science and technology support to U.S. combatant commands and Army service component commands.

Ellison’s work requires the right blend of skills and experiences. “I am most satisfied when I am able to see advancements in technology or capabilities reach the warfighter,” she said. “If I were to hire someone for my job, I would seek out someone with a variety of acquisition experiences under their belt, in addition to the typical program management and contracting certifications.” Throughout her time in the AAW, she

has relied on the team of experts at Defense Acquisition University when faced with new challenges. “One of my mentors has always come to my rescue,” she said.

In fact, those mentors and teammates have been vital to her career. “Having a strong network has been the key to my success,” Ellison said. “I have found that those who have taken advantage of at least one challenging, nontraditional assignment are quicker to successfully assimilate into the commands that they support and find their utility. They also tend to seek out more creative or innovative solutions to problems and tend to be willing to take more risks.”

Because she possesses that breadth of experience, Ellison quickly addressed one of the most difficult parts of her job—geography. “A good deal of my support is an ocean away,” she said. The scenario is familiar to most of her colleagues who have worked overseas, but it is difficult nonetheless. “Every decision, meeting or discussion must consider the challenge of differing time zones, travel, connectivity and the impersonal nature of a telephone conference.” Drawing on her interpersonal skills and the knowledge she had gained in the Army, Ellison created a communication and engagement plan to address those hurdles.

“The basic structure of my plan was to conduct an in-person, grassroots campaign of engaging in office calls, site visits and participating in key global engagements,” she said. “My intent was to show up in person, shake hands and make introductions. People still really appreciate the opportunity to take a few minutes to dialogue and exchange ideas in person.”

Ellison said her plan was all about personal connection and maintaining relationships, a lesson she learned from her family’s large holiday parties and gatherings as a child. “My mom has always made the effort to have family events,” she said. She saw the deeper value of strengthened interpersonal connections at those large—and often boisterous—social gatherings, and has worked to foster those same face-to-face interactions with colleagues, when possible. Perhaps not surprisingly, she is a fixture at unit gatherings, promotions and hail-and-farewell events of every variety, helping her colleagues to feel a part of “Team Army.”

She has some pragmatic advice for junior officers informed by her skills, experiences and personality. “When I am asked for career advice, my standard response is to find out what you like, compare it to what you are good at and search for a job that allows you to pull in some of both and still make money,” she said. “That nexus will get you through the tough days. Not many people do jobs that they like or enjoy. I love my job and it is satisfying knowing that I have made a difference. My certifications and educational pursuits have prepared me for life after the Army. I did not want to be a retiree with a degree that I had never exercised at the end of my career or experiences that I do not translate into civilian employment.”

To Ellison, military service is more than just a career. “I come from a legacy of military service members,” she said. “It is the family business. I stayed [in the Army] because there was always another challenge or adventure and the Army appreciated my motivation.” She’s created something artful, after all.

— ELLEN SUMMEY



**“I always planned to move to Paris to attend culinary school or to return to art school to design beautiful shoes in London.”**



### **DON'T GO THERE**

Bridge contracts are often used to prevent service disruption after a contract ends, when a new contract is not immediately awarded. They are intended to “bridge” the interim. Without proper planning and oversight, however, these contract actions do not offer the best value to the government. (Image by Getty Images)



---

*ON CONTRACTING*

---

# AVOID BRIDGES TO NOWHERE

DOD awards too many bridge contracts, limiting competition. Here's how to fix that.

*by Dennis P. Longo*

*The third article in the On Contracting series, based on the Competition in Army Contracting course developed by the author for the Office of the Deputy Assistant Secretary of the Army for Procurement.*

It's been said that greatness is not measured by the walls we build, but by the bridges. Department of Defense leadership disagrees.

For several years, DOD has exploited the use of temporary contract extensions without obtaining competitive bids. Known as bridge actions, these temporary extensions weren't necessarily planned in advance, but have often been used as a way to prolong delivery of items or services under a contract until a replacement contract is awarded.

Ellen M. Lord, then undersecretary of defense for acquisition, technology and logistics, issued a memorandum on Jan. 31, 2018, titled "Bridge Actions Reduction Measures and Reporting Requirement," observing that in fiscal year 2015, there were over 1,100 bridge actions with obligations exceeding \$13.7 billion. These bridge actions, in Lord's view, represent a lost opportunity for savings that could have been reached by awarding new, competitively awarded contracts.

Lord isn't the sole voice making this observation. A March 2012 U.S. Government Accountability Office (GAO) report (GAO 12-384) found that 18 of 111 justifications and approvals reviewed were bridge contracts with a total value of more than \$9 billion, with five of the 18 awarded as a result of protests. Of the remaining awards, the most frequent reasons for the bridge actions included changing office managers multiple times, difficulties writing requirements that met the contracting officer's standards, conflicting end-of-year responsibilities for contracting staff and extended length of time to approve acquisition strategies.

# Efforts to overcome the impact of a bridge action should routinely be explored.

A 2014 report (GAO 14-304) found that 12 of 34 contracts awarded on the basis of urgency were bridge contracts with a total value of more than \$466 million and an average period of performance of 11 months. The impact? Higher costs to DOD because of inefficiencies and the cost of administering bridge contracts, strain on the contracting workforce because bridge contracts must be justified and awarded while a follow-on contract is being sought, and the loss of benefits associated with full and open competition.

Another GAO report (GAO 16-15), released in 2015, examined the insight agencies had on the characteristics and reasons bridge contracts were used. GAO concluded that agencies have little to no insight into their use of bridge contracts, and that the period of performance of many bridge contracts spanned multiple years, increasing contract prices.

If you don't know where you're going, any road will take you there. A definition for "bridge action," also referred to as "bridge contract," does not exist in the Federal Acquisition Regulation (FAR) or Defense FAR Supplement (DFARS). This returns us to Lord's 2018 memo that established a DOD definition and guidance for bridge actions:

A bridge action describes a non-competitive action requiring a justification to include, but not limited to, a formal justification and approval (FAR Part 6 or 13.5), limited sources justification (FAR Subpart 8.4), and exception to fair opportunity (FAR Subpart 16.5), to retain the current or similar product or service as a result of delay in the negotiation and award of a follow-on contract.

## DOD 'BRIDGE ACTION' DEFINITION—A TWO-PART TEST

**Part 1: A non-competitive action requires a justification to retain the current or similar product or service.**

When the government solicits bids or proposals to award or modify a contract, the solicitation must promote full and open competition; that is, it must be issued without limiting competition. A "justification and approval" must be prepared for a contract award or contract modification that limits competition to one or more companies. For this part of the test, there must be a need to continue performance of an existing contract until a follow-on contract is awarded.

## Part 2: A result of a delay in the negotiation and award of a follow-on contract.

This second part of the two-part test applies where negotiation and award of a follow-on contract has been delayed.

What's a follow-on contract?

FAR 6.302-1(a)(2)(ii) characterizes a follow-on contract as a "contract for the continued development or production of a major system or highly specialized equipment."

As noted, reasons for awarding bridge contracts may be delays caused by bid protests, lengthy revisions to government procurement requirements or delays in awarding a contract, as well as delays that may be caused by an inexperienced and overwhelmed acquisition workforce.

The key, however, is that if there is no delay in the negotiation and award of a follow-on, the action is not a bridge action.

## OPTIONS AND BRIDGE ACTIONS

Under the "Option to Extend Services" clause at FAR 52.217-8, the government may require continued performance of any services within the limits and at the rates specified in the contract, not to exceed six months.

The contracting officer may invoke the clause to continue performance under the contract without full and open competition when the option was evaluated and priced at the time of award.

However, the clause is not "self-executing," meaning that the conditions and price of any option must be evaluated before they are acceptable by both parties.

Would you agree to let a waiter in a restaurant select an entree for you? Suppose you enter your favorite restaurant and order chicken marsala. The restaurant is out of chicken, so instead, the waiter serves you a bowl of mac and cheese. You tell the waiter,

“I asked for chicken marsala.” The waiter says, “I decided to replace the chicken marsala with the mac and cheese because we ran out of chicken” and walks away. Clearly, the waiter cannot compel you to buy the mac and cheese at his option without your consent.

Likewise, according to FAR 17.207(f), contracting officers must evaluate options when the contract is initially awarded so both parties understand and agree to the terms of the option and its cost.

However, when the option was evaluated and priced at the time the contract was initially awarded, the option may be exercised to “bridge,” or extend, the contract’s period of performance until the follow-on contract is awarded. In such cases, executing the clause is NOT considered a bridge action.

Executing the clause is considered a bridge action when the clause was NOT evaluated and priced at the time of award of the contract or order, thus requiring a justification to limit competition.

## THE JUSTIFICATION

The rationale for the bridge action must focus on (a) why and how the delay occurred; (b) why the bridge action is needed; and (c) how to resolve the delay.

To explain why and how the delay occurred, the rationale should focus on the specific circumstances of the delay, when it occurred, what we did to overcome the circumstances and why the delays could not have been mitigated.

To explain why the bridge action is needed, the rationale should focus on why we waited until now to request it, include specific dates in explaining when the delay occurred, and describe how the cost estimate was calculated, how



## AUTOMATIC SUBSTITUTIONS

If you ordered a cheeseburger and the chef substituted an expensive steak instead, would you be forced to pay for the upgrade? A contracting officer may invoke the “Option to Extend Services” at FAR 52.217-8, but the conditions and price of any option must be evaluated before they are acceptable by both parties. (Image by Getty Images)

the period of performance for the bridge action was calculated and what injury the government will sustain if the bridge is not executed.

To explain how to resolve the delay, the justification for the bridge action should include a milestone chart to illustrate where we intended to be when we initially determined the schedule for award of the follow-on

contract, as well as an explanation of how the revised dates for award of the follow-on contract were estimated. The milestone chart may, for example, provide the original procurement events, the dates those events were estimated to be accomplished a record of revised dates that surpassed the initial dates, with reasons explaining why the scheduled events and initial dates were surpassed. (See Figure 1, Page 98.)

FIGURE 1

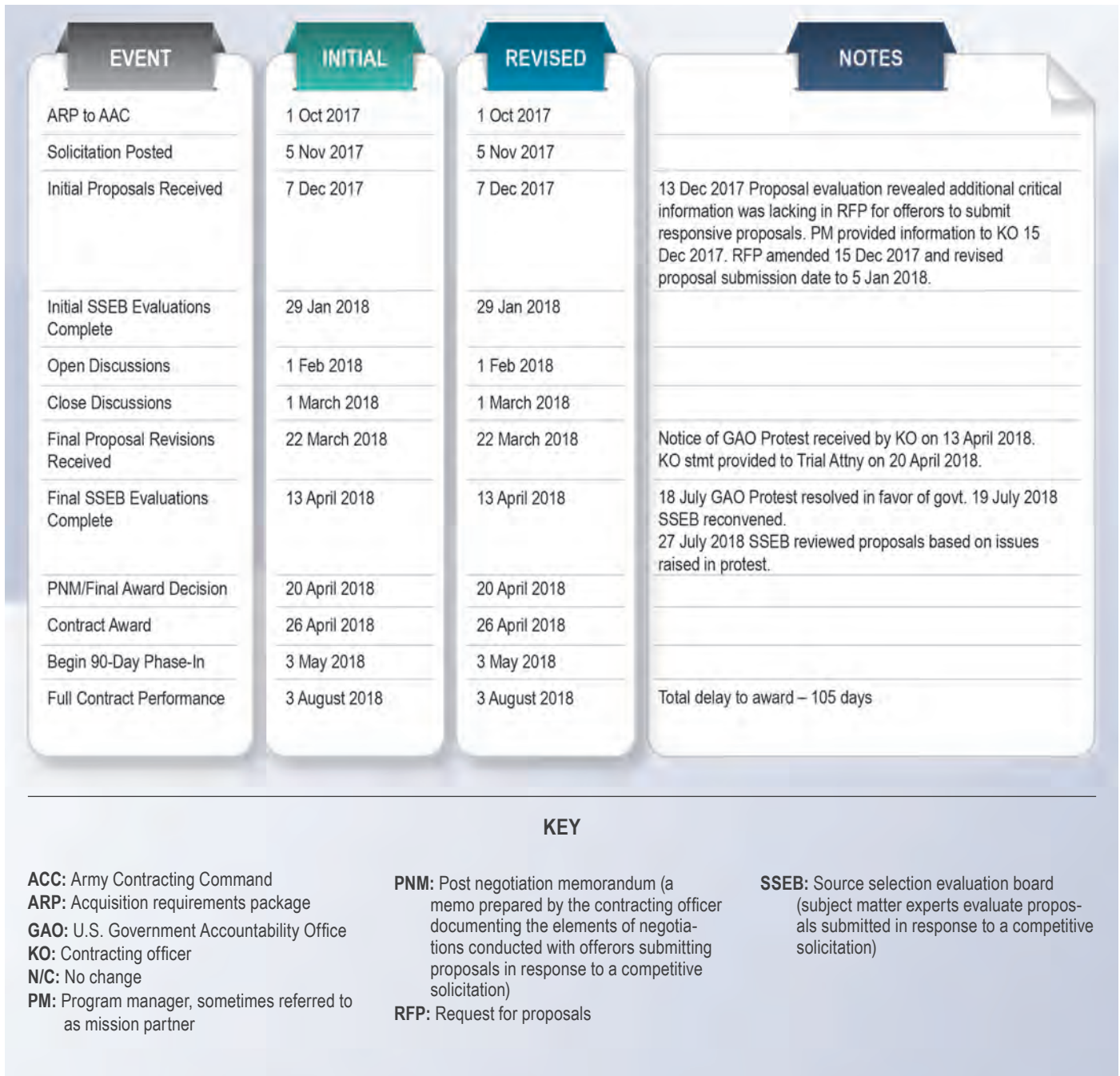

**MILESTONES TO BRIDGE ACTION**

This example of a milestone chart provides the original procurement schedule in the Events column, the estimated dates of accomplishment in the Initial column, and a record of Revised dates that surpassed the Initial dates, with reasons in the Notes column. In this example, resolution of the protest will require a bridge action to modify the “full contract performance” date by 105 days. (Graphic by U.S. Army Acquisition Support Center; SOURCE: The author)

## CHALLENGES TO BRIDGE ACTIONS

### 1. Don't let assumptions justify your actions.

*Key point:* Don't assume the necessity for a bridge action outweighs the requirement to conduct proper market research.

FAR Part 6 requires that notices of proposed contract actions have been published and any responses considered before award of a sole-source contract using the "only one responsible source" and "no other supplies or services will satisfy agency requirements" exception to full and open competition.

An agency published a notice of its intent to award a sole-source bridge contract to a company named MTC for a six-month period, including an option to extend services for an additional six months, and invited all responsible parties to submit capability statements. Career Systems Development Corp. submitted its capability statement to the agency as directed by the pre-solicitation notice. A day after the notice was published, the agency's chief procurement officer signed the sole-source justification and approval and awarded the sole-source contract to MTC. The justification and approval stated that no other firms expressed an interest in the procurement.

Career Systems Development Corp. protested the sole-source action (B-411346).

It argued that the sole-source justification was deficient because the agency failed to consider its capability statement and the justification was the result of a lack of advance procurement planning.

The agency maintained that the invitation for capability statements was a "mere formality" and that the consideration of Career Systems Development's capability statement was "actually irrelevant" to determining whether the agency's sole-source decision was reasonable.

**If there is no delay in the negotiation and award of a follow-on, then the action is not a bridge action.**

In sustaining the protest, GAO ruled that the agency's failure to meaningfully assess any offeror's ability to perform the requirement with minimal disruption was improperly justified.

### 2. Don't proceed in the company of predetermined conclusions.

*Key point:* Poor time management does not justify executing a bridge action.

In *Global Dynamics LLC v. U.S.*, No. 17-1875C, the U.S. Court of Federal Claims found that award of a bridge contract lacked a rational basis.

As a result of a number of protest actions, an agency posted its intention to award a fifth sole-source bridge contract to the incumbent contractor. This fifth bridge action increased the originally estimated 120 days to more than 250 days because (1) three retirements resulted in a personnel shortage; (2) available personnel were working on a number of other matters; and (3) the expected value of the contract was significantly increased, requiring additional work.

Global Dynamics LLC challenged the fifth bridge contract, arguing that the agency's decision to award the bridge was improper and prejudicial. The Court of Federal Claims agreed, stating that staffing, prioritizing other work and the increased work under the contract were all the result of the agency's failures.

### 3. Don't avoid the fact that we knew the contract expiration date when the contract was initially awarded.

*Key point:* Lack of planning does not justify limiting competition. [See FAR 6.301(c)(1).]

In *Innovation Development Enterprises of America Inc. v. U.S.*, No. 11-217C, an agency had 5½ years available to plan for its follow-on procurement and failed to do so before awarding a sole-source bridge contract to the incumbent.

The agency's justification was that market research could not be done in the short time available, and that currently no other contractors existed with both the technical and professional skills necessary to support the requirement.

The Court of Federal Claims sustained the protest, saying that the agency could not have been unaware of the expiring five-year contract with the incumbent "well in advance" of the bridge

action. The sole-source contract involved a lack of planning, irrational reasoning and numerous violations of procurement law and regulations.

### REDUCING THE IMPACT OF BRIDGE ACTIONS

Bridge actions may be unavoidable, particularly when a protest delays a contract award. However, efforts to overcome the impact of a bridge action should routinely be explored. For example:

#### 1. Focus on the elements that must be maintained until the follow-on action is awarded.

It may not be necessary to extend the full suite of performance requirements that are identified in a performance work statement in order to support the immediate mission requirement. Identify only the mission-essential elements of the work statement that must be maintained without a gap in performance until the follow-on action is awarded.

Once mission-essential elements are identified, calculate the cost and performance term of those essential elements for use in the justification for the bridge action.

#### 2. Reduce the amount of work that must be performed under the bridge action.

Review the contract’s statement of work to reduce or eliminate elements that can be postponed until the follow-on contract is awarded.

#### 3. Divide the requirement and issue separate competitive actions.

Divide the immediate requirement into individual procurement requirements that may be separately issued under full and open competitive procedures until the follow-on action is awarded. Competitive procedures include:

- Small business set-asides under FAR Subpart 19.5.
- 8(a) Program set-asides under FAR Subpart 19.8.
- Set-asides under the Service-Disabled Veteran-Owned Small Business Procurement Program or Women-Owned Small Business Program.
- Orders placed under multiple-award task or delivery order contracts pursuant to FAR Subpart 16.5.
- Orders placed under indefinite-quantity contracts.

#### 4. Take advantage of the flexibility permissible by the “Changes” clause.

Identify elements of the requirement that may be executable by operation of that clause to reduce the total impact of the bridge action

The “Changes” clause ensures flexibility that the government requires during performance of a contract and affords the contracting officer the discretion to order additional work within the scope of the contract without providing for full and open competition.

### CONCLUSION

Bridge actions endure high-level and persistent scrutiny. The rationale in the justification must focus on why we need the bridge action in the first place. Do not avoid the fact that we knew the contract would expire when we initially awarded the contract. Justify the proposed period of performance and the estimated cost for the bridge contract. Tell the story, be precise and include dates. Don’t let haste result in impulsive or potentially irresponsible actions; don’t proceed in the company of assumptions or predetermined conclusions; and tell the truth, the whole truth and nothing but the truth.

*For more information, view the Competition in Army Contracting course at <https://go.usa.gov/xvy7z>. This site is CAC enabled.*

---

*DENNIS P. LONGO is the advocate for competition, task and delivery order ombudsman and senior procurement analyst for Army Contracting Command at Aberdeen Proving Ground, Maryland. A member of the Army Acquisition Corps, he holds a bachelor’s degree from the University of Baltimore and is Level III certified in contracting. His assignments include acquisition specialist at the Program Manager for Chemical Demilitarization within the U.S. Army Chemical Materials Activity and procurement analyst at U.S. Army Legal Services Agency. He served in the military from 1971 to 1973 at the Southern European Task Force, Italy and was deployed to Iraq as a civilian in 2003. He authored the DAU Continuous Learning DOD Purchase Card Tutorial in 2002 and the Deputy Assistant Secretary of the Army for Procurement Competition in Army Contracting course in 2019. He has been teaching courses on competition in contracting since 2004. The first of the author’s On Contracting articles appeared in the Winter 2020 edition of Army AL&T.*

# MEASURE WHAT MATTERS

| Improving stakeholder engagement helped the 418th CSB advance the way they do business.

*by Jim Clift*

In contracting, there is often an imbalance between the less complicated, more comfortable tasks related to contract compliance and the murkier, less straightforward and more challenging tasks associated with stakeholder—customer, warfighter and requiring activity—engagement. The 418th Contracting Support Brigade (CSB) managed to improve stakeholder engagement and saved the government money by reducing the number of noncompetitive contract extensions, known as bridging actions, from fiscal year 2017 to 2019. (See Figure 1, Page 104.)

Warfighter commands must make tough spending choices in the pursuit of maintaining readiness. Not only are bridging actions costly, but they also require contracting professionals to devote time working on both the follow-on contract and the bridging action. While bridge contracts can be necessary tools, the 418th CSB and its requirement activity partners over-relied on them, mostly because of contractor protests, delays in requirements planning and source selection, and unexpected expansion of requirements.

It was apparent to the 418th CSB leadership that an improvement in stakeholder engagement during the requirements planning phase would translate to an improvement in reducing bridge contracts.

Coincidentally, a 2016 Volcker Alliance survey asked 38 government procurement leaders to examine core competencies of the contracting workforce. Procurement leaders rated stakeholder engagement and requirements planning as poor when compared with the contracting workforce's ability to follow contracting processes. (See Figure 2, Page 104.) This only reinforced the 418th CSB's commitment to change.

## **USE THE TOOLS AT YOUR DISPOSAL**

The 418th CSB challenged itself to better balance the tasks associated with stakeholder engagement and contract compliance-oriented tasks. Pivoting toward better engagement with our customers meant replacing outdated manual processes with an automated tool called the Virtual Contracting Enterprise (VCE). It also meant developing a leading metrics



**FINDING THE BALANCE**

The 418th CSB wanted to balance the tasks associated with stakeholder engagement and contract compliance-oriented tasks. Better engagement with customers meant replacing outdated manual processes with the automated VCE tool. (Image by Getty Images/NiseriN)

program to measure how effective both customers and contracting professionals were at integrating their efforts in VCE.

Up until this point, the 418th CSB received customer requirements piecemeal through email and a point-to-point transmittal of only the purchase request from the customer’s accounting system to the contract writing system. VCE tied these piecemeal messages together through its platform, where both customer and contracting could virtually plan acquisitions and track key milestone events.

**LATE ACQUISITION PLANNING**

A 2016 U.S. Government Accountability Office (GAO) report titled “Sole Source Contracting: Defining and Tracking Bridge Contracts Would Help Agencies Manage Their Use,” found that of the 73

delays in bridge contracts reviewed, 62 resulted from late acquisition planning documents and source selections. The report further noted that “bridge contracts occur when a delay in the acquisition process prevents the award of a competitive follow-on contract until after the contract in place is due to expire.”

Similar to the GAO scope, the 418th CSB, from fiscal year 2018 to the current fiscal year, found that 31 of 62 bridge contracts were linked to late acquisition planning documents and source selection delays. Determining the number of bridges was possible only because of the VCE system. Beginning in October 2017, Army contracting activities could track both the number of and reasons for bridging contracts because the Program Executive Office for Enterprise Information Systems and the Office of the Deputy Assistant

Secretary of the Army for Procurement worked in concert to develop a mechanism through the Business Intelligence module in VCE that captured bridge information. These lagging metric VCE reports, which recorded what had already happened, allowed subordinate organizations like the 418th CSB to create leading metrics to improve organizational goals.

Leading metrics measure events before completion and drive the behavior required to improve organizational goals. In other words, leading measures improve lagging organizational goal metrics. (See Figure 3, Page 105.) The 418th CSB created two leading metrics that were sent out to the workforce each week. Both tracked whether the customer and contracting professional did their part in using the VCE customer involvement tools. As Figure 3 details, the 418th CSB far exceeded the rest of the Army in meeting customer involvement goals. By measuring what matters—early and integrated planning with our requiring activity partners—the 418th CSB identified delays in the acquisition process that could trigger a bridging action.

**An improvement in stakeholder engagement during the requirements planning phase would translate to an improvement in reducing bridge contracts a bridging action.**



## LEADERSHIP MATTERS

When Gen. Gustave F. “Gus” Perna assumed command of U.S. Army Materiel Command in September 2016, he brought with him the concept of “operationalizing” his command. Perna defined operationalizing as a “process requiring vision, time and resources. An understanding, knowledge and appreciation of the capabilities of organizations across the Army, and the best methods and approaches of synchronizing and coordinating across those capabilities to achieve objectives.”

As effective subordinate units are inclined to do, the U.S. Army Contracting Command operationalized its own contracting support vision to align with Perna’s. This nesting effect continued through the U.S. Army Mission and Installation Contracting Command to the 418th CSB.

In order to manage operationalizing 418th CSB’s goals of timely contracting support (Figure 4, Page 105), the brigade commander and deputy to the commander established the Customer and Field Support Division. At its core, the division’s mandate was to assist acquisition teams in navigating the time-consuming procurement process, foster a collaborative environment and identify solutions to roadblocks that clearly exceed the costs to administer and enforce.

Parallel to the 418th CSB’s efforts, senior Army leaders began pushing for stronger acquisition teaming efforts. The Army vice chief of staff published a memo directing requiring activities to use VCE. The Army Federal Acquisition Regulation Supplement Subpart 5104.802(f)(i)(5) directed contracting offices to assist their requiring activities in using VCE.

Both the Mission and Installation Contracting Command and Army

Contracting Command published strategic objectives to operationalize contracting by integrating contracting and customer milestones. Each of these leadership directives allowed the 418th to advocate for, promote the use of, and train acquisition teams on VCE.

Operationalizing contracting also meant leadership taking a vested interest in demonstrating a clear relationship between early stakeholder engagement and its effect on reducing bridging contracts. The Office of the Deputy Assistant Secretary of the Army for Procurement developed Army-level policies to manage and track bridge contracts. These policies empowered competition advocates to adopt new initiatives, which increased competition and allowed for further analysis to target improvements across the

command. Special recognition is reserved for the competition advocate at Mission and Installation Contracting Command headquarters, Scott Kukes, for working tirelessly to validate bridging data inputted to VCE. Increased accuracy gave the 418th CSB a better picture of the relationship between the delay in the follow-on contract and the current extension or stand-alone bridge.

## SHARED AUTOMATION MATTERS

A “stovepiped system” is a term for a system that has the potential to share data or functionality with other systems but does not do so. Before VCE, the Army was unable to share an entire requirements package for complex, high-cost services. This was because of two stovepiped systems, the General Fund Enterprise Business System



## ENGAGING THE STAKEHOLDER

It can be much harder work in contracting than checking off compliance boxes, but early and integrated planning with requiring activity partners is key, the 418th CSB found, to avoiding contract bridging actions. (Image by Getty Images/olm26250)

FIGURE 1

FISCAL YEAR	# OF BRIDGES	CEILING (NEW) OR CHANGE IN CEILING (MODS)
2019	23	\$134,420,474
2018	27	\$282,479,597
2017	45	\$365,523,425

**REDUCTION IN BRIDGE ACTIONS**

The 418th CSB reduced, by almost half, the number of noncompetitive contract extensions from fiscal year 2017 to 2019, in the process avoiding the expenditure of hundreds of millions of dollars that the bridge contracts and modifications would have paid. (Graphic by 418th CSB and U.S. Army Acquisition Support Center (USAASC))

FIGURE 2

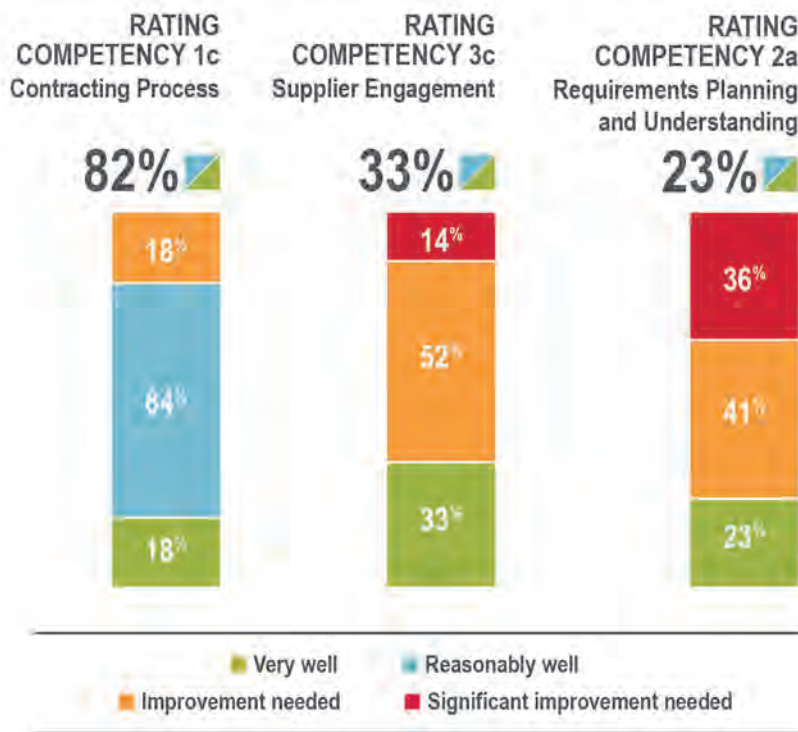

The Volcker Alliance report 'Doing the people's business: key competencies for effective public procurement'

**NEEDS WORK**

Looking at the competencies of the contracting workforce, procurement leaders rated stakeholder engagement and requirements planning as poor when compared with the ability to follow contracting processes. (Graphic by 418th CSB and USAASC)

**Bridge contracts occur when a delay in the acquisition process prevents the award of a competitive follow-on contract until after the contract in place is due to expire.**

on the customer side of the fence, and the Procurement Desktop-Defense contracting system on the other. With VCE, a ready-made tool now existed that shared the entire requirements package with both the customer and contracting.

To organizations like the 418th CSB, VCE provided the sharing tool needed to capitalize on improving stakeholder engagement. In the fall of 2018, the command implemented an awareness and training campaign to promote the use of VCE with the goal of deploying its customer integration tools by January 2019. In all, the 418th executed eight separate virtual training sessions to over 500 customer and contracting VCE users.

**CONCLUSION**

Improving stakeholder engagement and reducing bridge contracts are a culmination of the efforts of the dedicated military and civilian workforce of the 418th CSB. Their commitment to accomplishing the

mission and adapting to new ways of thinking created a sense of pride throughout the organization.

Prioritizing stakeholder engagement tasks by creating a brigade Customer and Field Support Division and using VCE customer integration tools had the intended effect of helping the 418th CSB decrease its number of bridge contracts. Between fiscal years 2017 and 2019, the brigade observed an almost 50 percent reduction in the number of bridging actions and a 63 percent decrease in dollars obligated toward bridges.

Of course, many other factors also contributed to the brigade’s reduction in bridging actions, including a proactive competition advocate and dedicated acquisition team members armed with leadership resolve. Changing course is difficult, but the 418th CSB proved that committed leadership aligned to people and processes, coupled with an automated tool, can fundamentally improve outcomes.

*For more information, contact Jim Clift at [james.l.clift.civ@mail.mil](mailto:james.l.clift.civ@mail.mil).*

*JIM CLIFT is the supervisory procurement analyst for the 418th Contracting Support Brigade’s Customer and Field Support Division, U.S. Army Mission and Installation Contracting Command at Fort Hood, Texas, and is a member of the Army Acquisition Corps. He graduated from the Army ROTC program at Southwest Texas State University with a B.S. in geography. He was commissioned in the Air Defense Artillery Corps in 1995, and then retired and began his federal civilian career in 2015. His advanced military education includes the U.S. Army Command and General Staff College and an MBA from Texas A&M-Central Texas.*

## By measuring what matters—early and integrated planning with our requiring activity partners—the 418th CSB identified delays in the acquisition process that could trigger a bridging action.

FIGURE 3

CONTRACTING COMMAND	AWARDS ISSUED	VCE CUSTOMER CABINET CREATION UTILIZATION RATE	VCE CUSTOMER REQUIREMENTS PACKAGE ASSISTANT UTILIZATION RATE
418th Contracting Support Brigade	1,381	77.34%	32.85%
Rest of the Army	14,607	32.51%	7.40%

### CUSTOMER INTEGRATION OUTCOMES

The 418th CSB far exceeded the rest of the Army in meeting customer involvement goals. As part of prioritizing stakeholder engagement tasks, the brigade replaced outdated manual processes with the automated VCE and developed a metric to measure how effective both customers and contracting professionals were at integrating their efforts in VCE. (Graphic by 418th CSB and USAASC)

FIGURE 4

CONTRACTING COMMAND	BEFORE PERFORMANCE OBJECTIVE ALIGNED TO METRIC CUSTOMER CABINET CREATION UTILIZATION	AFTER PERFORMANCE OBJECTIVE ALIGNED TO METRIC CUSTOMER CABINET CREATION UTILIZATION
418th Contracting Support Brigade	52.58%	84.59%

### OPERATIONALIZE CONTRACTING

The 418th CSB’s commander and deputy to the commander established the Customer and Field Support Division. This division assists acquisition teams in navigating through the time consuming procurement process, foster a collaborative environment and identify solutions to roadblocks. (Graphic by 418th CSB and USAASC)



# At Work

## Profile: Joint Program Executive Office for Chemical, Biological, Radiological and Nuclear Defense (JPEO-CBRND)

*One in a series, ASA(ALT) at Work, that looks into ASA(ALT) organizations, what they do and where they do it.*

The Joint Program Executive Office for Chemical, Biological, Radiological and Nuclear Defense (JPEO-CBRND) is the joint services' lead for development, acquisition, fielding and life cycle support of chemical, biological, radiological and nuclear (CBRN) defense equipment and medical countermeasures. As an effective acquisition program, JPEO-CBRND puts capable and supportable systems in the hands of service members and first responders, when and where needed, at an affordable price. Our vision is a resilient joint force, enabled to fight and win, unencumbered by a chemical, biological, radiological or nuclear environment and championed by innovative and state-of-the-art solutions.



### ▲ THE RIGHT CONNECTIONS

Development of effective antiviral treatments is both a national security and a defense priority, particularly as the nation responds to the ongoing COVID-19 pandemic. The development of remdesivir grew out of a partnership that JPEO-CBRND had with Gilead Sciences Inc. Now the drug shows promise against coronaviruses. (Photo by Getty Images/Teka77)

### *What should we know about JPEO-CBRND?*

The warfighter is the centerpiece of everything we do.

We support all the service branches and serve as a committed teammate. The Army is our executive agent through the assistant secretary of the Army for acquisition, logistics and technology (ASA(ALT)) and we receive funding and oversight through the Office of the Secretary of Defense.

We work closely with our interagency, academic and international partners to provide the best CBRN defense equipment and medical countermeasures.

Our headquarters is at Aberdeen Proving Ground, Edgewood Area, Maryland, with offices across the United States.

**ORGANIZATION LEADERSHIP**

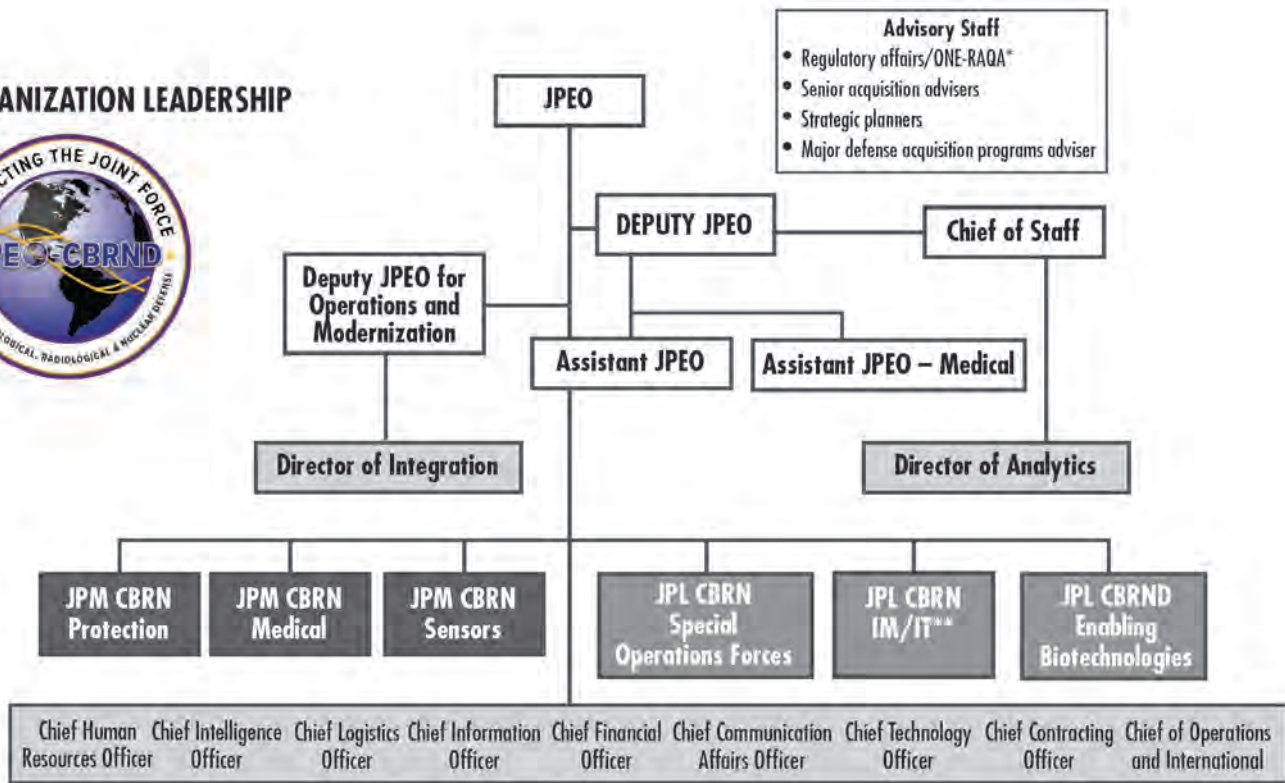

**LEGEND**

- Front Office    Headquarters    Joint Program Manager    Joint Program Lead     Operational control (OPCON)
- Administrative control (ADCON)
- \* One Network of Excellence – Regulatory Affairs and Quality Assurance
- \*\* Information management/information technology

### *What is JPEO-CBRND doing in support of modernization?*

The Army requires modernized, mounted CBRN reconnaissance capabilities to meet future operational requirements and address weapons of mass destruction threats from near-peer adversaries. However, the current Stryker Nuclear Biological Chemical Reconnaissance Vehicle (NBCRV) Sensor Suite was using 23-plus-year-old technology, posing a challenge to operational readiness rates because of the complexity and obsolescence of the CBRN sensors. The Stryker NBCRV Sensor Suite Upgrade (SSU) program is an example of how to embrace the principles of acquisition reform and the support of senior leaders to accelerate from design to development.

To achieve the Army’s goals of readiness and modernization, JPEO-CBRND assessed new

and existing technology to upgrade the sensor suite package on the NBCRV and thus allow it to perform reconnaissance autonomously. This modernization effort incorporated six specialized chemical agent sensors into one uniform package, bringing the NBCRV sensor capabilities up to date with current technologies and ultimately readying the NBCRV for modern Army maneuver support.

The upgraded sensor suite package increases the standoff distance of chemical weapon sensing significantly, keeping warfighters out of the most hazardous environments of the battlefield by performing remote and on-the-move detection. The NBCRV SSU program built prototypes that integrated additional detection while still



◀ **EXPEDITED TREATMENT**

The U.S. Department of Health and Human Services leveraged an other-transaction authority, established by JPEO-CBRND, to develop a COVID-19 diagnostic test for domestic use. The test works on Cepheid's GeneXpert GX4, left, and GX16 systems, used worldwide to test for infections such as tuberculosis, HIV, Group A streptococcus, influenza and now COVID-19. (Photos courtesy of Cepheid Inc.)

▶ **GOING ONE BETTER**

The BioFire FilmArray is a diagnostic system designed to deliver results within one hour. Existing BioFire test panels would not recognize COVID-19 specifically, so the JPEO-CBRND, supported by DOD, worked with BioFire to rapidly develop a single COVID-19 test. It now has an FDA emergency use authorization and is available for use. (Photo by Joint Project Manager for CBRN Medical Graphics)



▲ **MAJOR MOUNTED PLATFORM UPGRADE**

The NBCRV SSU, pictured during a demonstration at Aberdeen Proving Ground South in 2019, uses unmanned systems teaming with a manned platform, leveraging land and air robotic platforms and sensor technologies to detect and identify hazards and communicate back to the commanders making decisions. (Photo by Brandon Leibowitz, JPEO-CBRND)

*"I am tremendously proud of our team's ability to successfully design and build fully integrated prototypes in 100 days for the Defense Department's CBRN mounted reconnaissance capability for manned and unmanned systems. This dedication and commitment enabled us to deliver the first integrated prototype three years ahead of schedule."*

— Lt. Col. Jeffrey Strauss

reducing the size of the system and developed command-and-control software to align with C5ISR Mounted Mission Command. (C5ISR is command, control, communications, computers, cyber, intelligence, surveillance and reconnaissance.) It also demonstrated platform adaptability by integrating onto a new unmanned ground vehicle and an unmanned aerial vehicle, translating all the data from those sensors to usable information for the Soldier and the chain of command.

Senior leader support for acquisition reform made the rapid pace for this modernization possible. An operational requirement document was used instead of developing a new capabilities development document, and a modified work order was used to reduce testing requirements and cost and increase the speed of delivery to the warfighter. Modular open system architecture enabled parallel development of the CBRN sensors and the platform integration.

“Establishing a systems integration lab locally facilitated rapid integration and testing of capabilities across the enterprise. This allowed us to conduct highly successful demonstrations in the Aberdeen Proving Ground area,” said Lt. Col. Jeffrey Strauss, joint product manager for Reconnaissance and Platform Integration. Using these methods, the Stryker NBCRV SSU program designed and constructed fully integrated prototypes within 100 days from receipt of the validated requirement.

### ***Where does JPEO-CBRND fit into the bigger picture?***

One of the responsibilities of the JPEO-CBRND is to make medical countermeasure capabilities available to those who need them. As such, the organization has existing capabilities and expertise to rapidly respond to COVID-19, particularly in product development, manufacturing, clinical trials management and fielding. JPEO-CBRND has been engaged in COVID-19 response efforts since the

first cases were identified, supporting the Office of the Assistant Secretary of Defense for Health Affairs, which is the designated health lead for DOD’s COVID-19 response.

“The JPEO-CBRND’s diverse portfolio allows us to respond to the COVID-19 pandemic through a comprehensive, three-pronged approach. Coordinated efforts to prevent, detect and treat this disease will facilitate the delivery of effective medical countermeasures that protect both warfighters and civilians alike,” said Col. Ryan Eckmeier, joint project manager for Chemical, Biological, Radiological and Nuclear Medical.

JPEO-CBRND has accelerated rapid response for DOD and interagency partners to meet objectives in detection, prevention and treatment.

## ***DETECTION AND DIAGNOSTICS***

JPEO-CBRND has made great strides in the fight to rapidly identify COVID-19, to prevent further spread of the disease and inform treatment options. The Next Generation Diagnostics System is already fielded to DOD and Centers for Disease Control and Prevention sites worldwide—with newly fielded systems increasing exponentially in response to the joint services’ demand—and is being used for COVID-19 testing.

Using the BioFire Defense LLC’s FilmArray device and associated respiratory panels allowed for identification of some types of coronavirus (such as those that cause SARS, severe acute respiratory syndrome, and MERS, Middle East respiratory syndrome) and the ruling out of other respiratory diseases presenting with symptoms similar to those of COVID-19.

However, existing BioFire respiratory panels would not recognize COVID-19 specifically. JPEO-CBRND addressed this capability gap by working with BioFire, using Defense Health Program funds and through the leadership of Dr. Terry M. Rauch,



▼ **MANNED-UNMANNED TEAMING**

During the Joint Warfighter Assessment 2019, the Army demonstrated the chemical detection capability of the Deep Purple drone in conjunction with the NBCRV SSU, teaming a robotic unmanned capability with a manned platform. (Photo by Brandon Leibowitz, JPEO-CBRND)

acting deputy assistant secretary of defense for health readiness policy and oversight within the Office of the Assistant Secretary of Defense for Health Affairs. The result was to rapidly develop a single COVID-19 test, which is now available for use under the U.S. Food and Drug Administration’s (FDA) emergency use authorization.

JPEO-CBRND is also facilitating interactions between the U.S. Department of Health and Human Services’ Biomedical Advanced Research and Development Authority (BARDA) and Cepheid Inc. to provide a diagnostic system and tests for diagnosis and treatment in public health. BARDA leveraged an other-transaction authority that was established by the JPEO-CBRND to develop a COVID-19 diagnostic test for domestic use.

JPEO-CBRND’s existing advanced development diagnostics program with Cepheid facilitated the

vital connection between the company and the agency, and enabled the Department of Health and Human Services to expeditiously address the demand for COVID-19 testing capabilities within the United States.

In addition, JPEO-CBRND partnered with the Naval Medical Research Center to assess and ensure the availability of diagnostic supplies needed to evaluate thousands of samples for COVID-19 laboratory testing.

**PREVENTION**

JPEO-CBRND is using the DOD Advanced Development and Manufacturing facility to make three protective products, two vaccines and one antibody, that are being manufactured to protect DOD personnel. These products are being developed in partnership with the Defense Advanced Research Projects Agency and



*“Support from the Health Readiness Policy and Oversight office spurred our efforts to develop and procure unprecedented COVID-19 diagnostic tests in record time. The delivery of BioFire’s COVID-19 test increases the DOD’s diagnostics capability and capacity and preserves the readiness of the joint force.”*

— Col. Ryan Eckmeier

the National Institutes of Health (NIH). Doses of these products will be accelerated for testing in clinical trials using this DOD capability and will be made available for early use by DOD personnel.

## **TREATMENT**

In 2016, the JPEO-CBRND partnered with Gilead Sciences Inc. to develop remdesivir, a broad-spectrum antiviral, to combat outbreaks of viruses that may affect our warfighters. Peer-reviewed journals have reported that the drug shows activity against coronaviruses. This existing relationship with a valued industry partner, along with the contributions of the JPEO-CBRND technical team—to leverage the Medical CBRN Defense Consortium’s rapid contracting capability, request submissions from across the industry and then review over 500 white papers—have accelerated efforts to repurpose the drug as a COVID-19 treatment.

Recently, JPEO-CBRND cooperated with inter-agency partners who develop medical capabilities for public health protection to make remdesivir available under a clinical trial. The JPEO-CBRND worked with the U.S. Army Medical Research and Development Command’s U.S. Army Medical Materiel Development Activity to establish a force health protection protocol with the FDA so that both service members and civilian DOD personnel who cannot participate in the NIH clinical trial have access to this treatment.

Remdesivir is now available under this protocol at 23 military medical treatment facility sites worldwide, with at least 11 DOD personnel recovering from COVID-19 after receiving the treatment. The JPEO-CBRND is also implementing observational clinical studies, in which the investigator makes no intervention and patients are allocated treatment based on clinical decisions, inside and outside of the continental United States. These clinical studies, which leverage well-established DOD clinical research networks, provide a standardized approach to collecting clinical data across the military health system and with international partners. These efforts will lay the foundation for studies of therapeutic and prophylactic (vaccine) products.

“The JPEO-CBRND’s COVID-19 response efforts have demonstrated our ability to mitigate the harm caused by emerging biological threats, when and where it really counts. We are able to leverage and tailor existing agreements with our industry and interagency partners to rapidly bring medical solutions to the fight against this pandemic,” Eckmeier said.

“We truly are all in this together,” he said. “While continuing the JPEO-CBRND’s mission to bring much-needed CBRN defense equipment and medical countermeasure capabilities to the joint force, the expertise and dedication of our workforce has allowed us to pivot quickly in support of an efficient and effective whole-of-government response to the COVID-19 pandemic.”



**DRAWING UP PLANS**

Members of 80th MCT support multiple III Corps units at Port Arthur, Texas, in anticipation of the Defender-Europe 2020 deployment. (Photo by Sgt. First Class Horacio Chanyau)

# THE 'PITCH AND CATCH' MOVEMENT APPROACH

49th Movement Control Battalion's early coordination and expanded services improve movements for deploying units, providing on-site expertise and allowing greater visibility of cargo in transit.

*by Maj. Stephen W. Hughes and Maj. Carl S. Miller*

**M**ovement control battalions train during their day-to-day operations in the U.S. to be prepared to facilitate movement during large-scale combat operations when the need arises. While it is said that an army marches on its stomach, there is a great deal more to moving an army than just feeding it. Movement control can mean the difference between victory and defeat.

In large-scale combat, or even in a blended fight, the enemy will target and may be able to affect sustainment bases, roads, information systems and strategic lines of communication. U.S. ground combat forces will seek to advance toward and through the enemy on a broad front. These advancing U.S. forces will press forward on multiple highways and back roads, spread hundreds of miles apart, to avoid vulnerability from weapons of mass destruction. During the offensive, movement control battalions (MCBs) can help maintain order, extend operational reach and increase velocity by adding regulation and stability where otherwise there would be chaos in the massive movement of cargo and supplies.

There is a delineation of the lines of responsibility between MCBs and other deployment support units that is not always apparent, but will be outlined below. The doctrinal model advocated here seeks to widen the scope of duties of MCBs beyond their traditional roles. In the U.S. Army's current deployment practices, brigades lose sight of their cargo once it departs from their military installation. But, in the spirit of doctrine, the MCB should be expeditionary and track cargo to air and sea ports, subsequently providing updates to deploying units until their ships and planes have departed port. In pursuit of that goal, the 49th MCB has become a customer-service-oriented organization that works directly for deploying units. In doing so, the MCB enables its customers to deploy farther and faster without pause or loss of accountability.



### CARGO INSPECTION

The 49th MCB Command Team inside a commercial vessel inspect cargo for 2nd Brigade Combat Team, 1st Infantry Division's deployment to Pacific Command at Grays Harbor, Washington, in January. (Photo by Maj. Stephen Hughes)

### THE GENESIS

In May 2019, the 49th Transportation Battalion (MCB) completed a nine-month rotation to Poland in support of Operation Atlantic Resolve. It facilitated the movement of all military convoys into and out of numerous states by liaising with national elements to authorize and control the movement, ensuring the completion of customs paperwork and assisting units when foreign authorities frustrated or delayed their cargo. Upon return from Europe, the 13th Expeditionary Sustainment Command's commanding general, Brig. Gen. Darren L. Werner, delivered his vision of the "MCB of the corps" model to the 49th MCB commander, Lt. Col. Travis Sept.

Werner's vision mirrored doctrine and is described in Army Technical Publication 4-16, Movement Control. However, MCBs do not follow the model in practice today. To bring about Werner's vision, the 49th MCB would become a III Corps

force multiplier, operating both on and off Fort Hood, Texas, and wherever III Corps' subordinate units traveled. On-site support would be provided for brigades and divisions on installations, at training centers and at air and sea ports for deployments. This tiered support in the United States would discipline and posture the MCB and translate to supporting large-scale combat operations abroad when needed, as described in Field Manual 3-0.

The MCB would have to fill in the gaps between tactical deploying units and the support elements at installation and commercial shipping sites. (See Figure 1.) Army field support battalions and the U.S. Army Military Surface Deployment and Distribution Command offer general support to deploying units at operational installation deployment nodes and strategic commercial ports globally. Their general support is to the Army as a whole, and not to any specific unit. It is passive and not targeted.

The direct support provided by an MCB, however, supports specific forces, and the MCB answers directly to the deploying unit. Deploying units need this. When experts do not go to the brigade's area of operations in active pursuit to aggressively assist the unit weeks before its scheduled date to put its equipment on trains, the brigade fails. Branch movement control teams align with brigades on a regular basis, and movement control teams (MCTs) align with divisions as well. This alignment provides maneuver commanders greater understanding and influence in their efforts to closely track combat power and make operational decisions based on when resources will arrive in theater.

Today, brigade and subordinate unit movement officers report to installation Army field-support battalion representatives at deployment nodes for technical expertise as their unit readies for deployment. However, many unit-movement officers are uninformed of the specifics of

## While it is said that an army marches on its stomach, there is a great deal more to moving an army than just feeding it.

their duties and fail to contact the Army field-support battalion in time. This is where the MCB should fill in the gap. To do this, MCBs select and send members of subordinate MCTs to deploying units months before the start of the cargo deployment dates. Those teams, four Soldiers in size, then work with brigade movement officers while they select which pieces of equipment will deploy and to input dimensional configurations into the Army's computerized deployment program, which is difficult without know-how on the highly technical requirements for movements by rail, sea and air.

Installation Army field support battalions coordinate with Surface Deployment and Distribution Command and brigade mobility warrant officers to obtain cargo deployment lists and complete the commercial booking for that cargo to move. The command also coordinates the movement windows in which units are expected to have cargo available at rail and line-haul sites. However, after the cargo leaves the military installation, the brigade has to seek out the location of its cargo using unreliable in-transit visibility websites. The command does not actively update and feed information to the brigade mobility warrant officers or influence the velocity of cargo movement at ports, beyond what was requested in the original commercial booking. As a strategic general support element, it is not the command's role to feed information to the tactical brigade as a specific customer. However, with the direct support of an MCT, the brigade receives real-time data on cargo location and gains active assistance to spur movement of stagnant cargo.

FIGURE 1

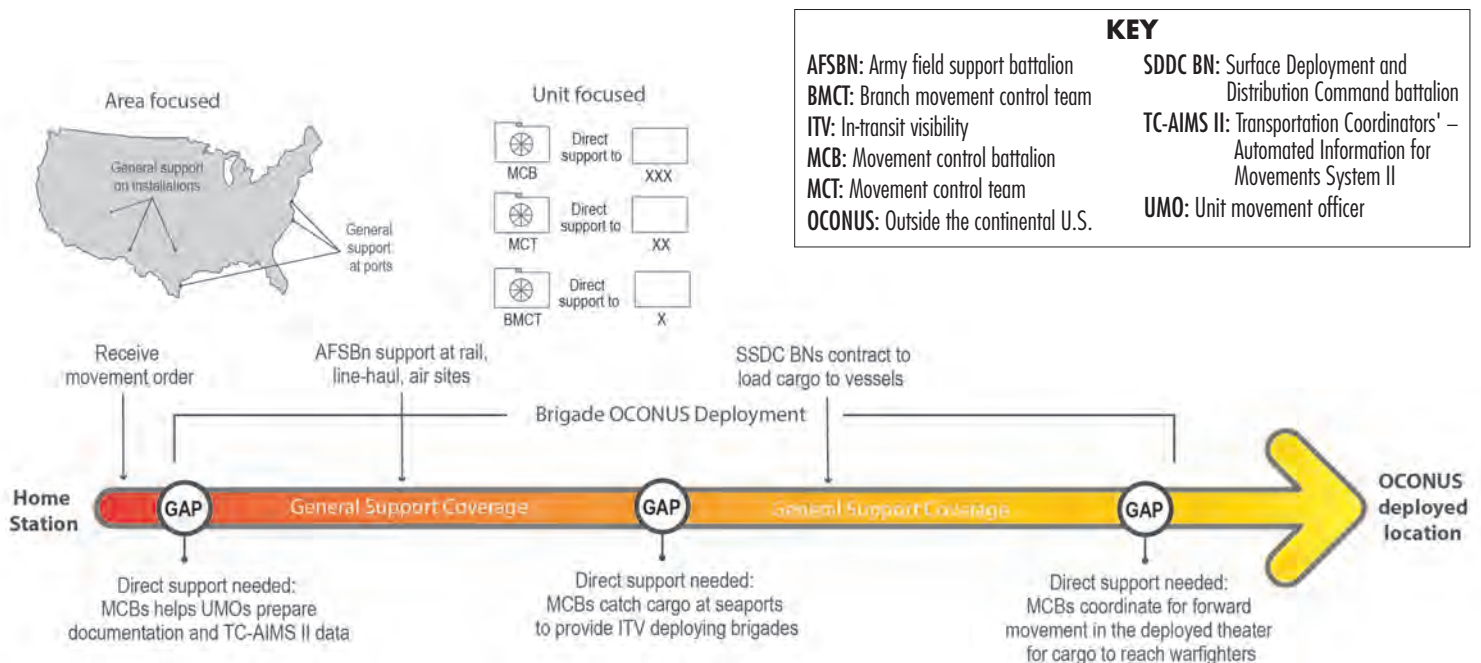

### MIND THE GAPS

The MCB would have to fill in the gaps between tactical deploying units and the support elements at installation and commercial shipping sites. (Image by U.S. Army Acquisition Support Center (USAASC))

FIGURE 2

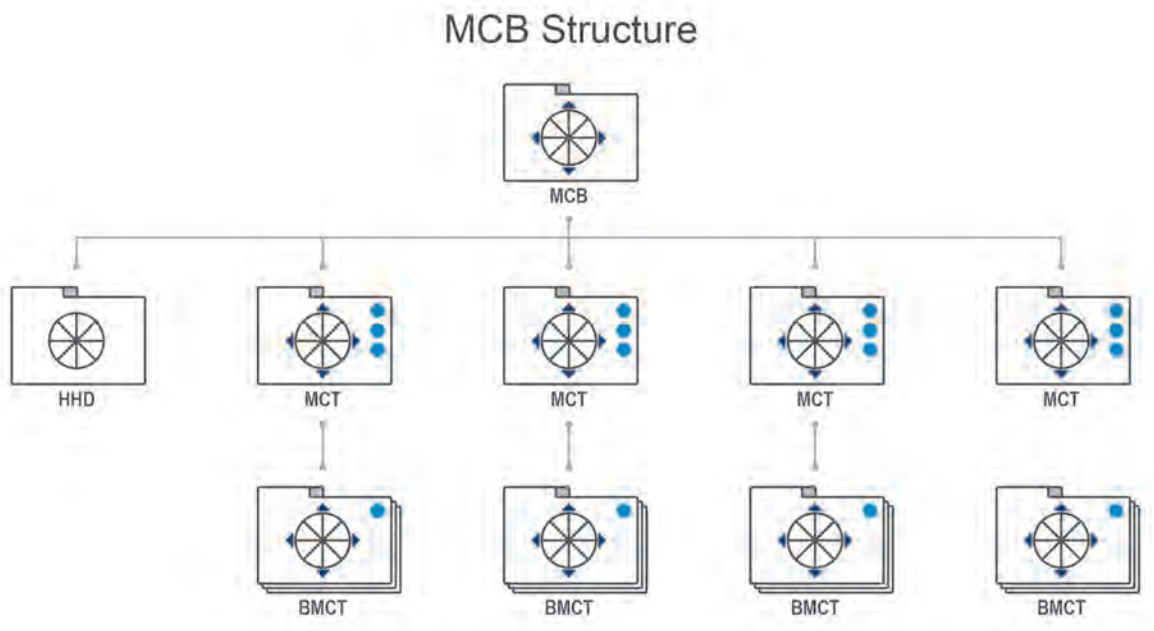

#### HOW MOVEMENT CONTROL BATTALIONS WORK

A movement control battalion (MCB) is organized with four 21-Soldier movement control teams (MCTs) and 16 four-Soldier branch movement control teams (BMCTs). (Image by USAASC)

#### PITCH AND CATCH

According to Army Technical Publication 4-16, MCBs provide support to units within a theater of operations, and they assist tactical units in gaining transportation support that comes from outside of the theater of operations. Within the U.S., III Corps' divisions and brigades use the 49th MCB to provide in-transit visibility of personnel, supplies and equipment moving through the transportation system. It also provides assistance with the minutiae of military cargo shipping in the ramp-up to deployment and while the cargo is in the deployment pipeline.

The 49th MCB, with four assigned MCTs and 16 branch movement control teams of four personnel each, can potentially cover 16 deployment sites. (See Figure 2.) This has allowed the 49th MCB to conduct "pitch and catch" operations with deploying cargo. For instance, in October and November 2019, three branch movement control teams at Fort Hood, Texas, staged at the installation's commercial trucking yards and railroad loading sites to send cargo to Fort Irwin, California, during a 3rd Cavalry

Regiment National Training Center rotation. The branch movement control teams provided the regiment visibility of its combat power build, before the start of the exercise and then again on return to home station.

While the Surface Deployment and Distribution Command and the Army field support battalions remain focused on running the day-to-day operations at ports, railheads and convoy yards, MCBs directly support the corps' subordinate units as customers. As such, while the 49th MCB headquarters is located at Fort Hood, the MCTs deploy and operate wherever III Corps units need them.

For the ramp-up to the Defender-Europe 20 exercise (planned to be the largest training exercise in Europe in 25 years), the 49th MCB deployed teams to Fort Bliss, Texas, supporting the 1st Armored Division; to rail and sea nodes at the Port of Beaumont and Port Arthur, supporting the 1st Cavalry Division; and to Fort Hood's railroad locations and airports, supporting multiple III



## FINAL PREPARATIONS

Members of the 259th MCT support 2nd Brigade, 1st Cavalry Division at Fort Hood during the Speed of War Exercise 2019. (Photo by Spc. Jonathan Haygood)

Corps and National Guard units. In addition, the 49th MCB deployed four small teams to Poland to support Defender-Europe 20 units and planned to send another two in April 2020, before the unexpected halt of the exercise because of the spread of COVID-19.

## CONCLUSION

The work of building relationships, training Soldiers and incorporating branch movement control teams into the deployment process to fill in gaps and assist deploying units is having positive effects today. As of April 2020, the 49th MCB headquarters is deployed to New Orleans, Louisiana, where it is serving as the movement control lead for the 377th Theater Support Command over three

expeditionary sustainment commands. The 49th MCB will soon have six to eight MCTs apportioned to them, to control the movement of doctors, nurses, hospital support personnel and associated supplies to points of need.

By training Soldiers in MCTs to work at installation support nodes before the spread of COVID-19 and training the headquarters staff to track and direct the work of the MCTs at deployment sites, the 49th has ensured that cities get what they need when they need it. The battalion will deploy branch movement control teams to cities across the U.S. to work at makeshift convoy rally points and at commercial airports. While different than the expected mission, the 49th MCB is

prepared to fight COVID-19 because of the work it conducted to prepare for a near-peer threat.

Post-COVID-19 response, the 49th MCB will further build relationships with Surface Deployment and Distribution Command's 833rd and 834th Transportation Battalions with seaports on the West Coast, the 841st Transportation Battalion on the East Coast and the 842nd Transportation Battalion in Texas. By 2021, the 49th also plans to mirror its Fort Hood partnerships with the Army field support battalions at other large posts containing III Corps subordinate units: Fort Bliss, Fort Riley, Kansas, and Fort Carson, Colorado. Integrating dispersed MCTs directly into the work at Army field support battalions will both build the capability of the corps and act as a force multiplier for the corps' subordinate divisions.

*For more information, contact the 49th Movement Control Battalion at 254-287-1664 or see Army Technical Publication 4-16, Movement Control.*

*MAJ. STEPHEN W. HUGHES is the battalion S-3, 49th Movement Control Battalion at Fort Hood. He holds an MBA from the University of Utah and a bachelor's degree in political science from Utah State University.*

*MAJ. CARL S. MILLER is the battalion executive officer for the 49th Movement Control Battalion at Fort Hood. A graduate of the Advanced Military Studies Program, he holds an M.S. in psychology from the University of Phoenix, an M.A. in military operations from the U.S. Army Command and General Staff College and a B.A. in history from Stephen F. Austin State University.*

## OVER THE RIVER

NATO Allied Rapid Reaction Corps officers visit British Royal Engineers in Germany as they prepare for river crossing drills in February. ERDC's Streamflow Prediction Tool provides 15-day continental scale streamflow forecasts to allow planners to quickly gauge river crossings in any part of the world. (Photo by British Army Sgt. Alistair Laidlaw)





# UNDERSTANDING THE BATTLEFIELD

Army ERDC supports multidomain operations, creating a transformation in battlefield situational awareness and planning through advanced geospatial technologies.

*by Dr. Robert Davis and William Jones*

*The second in an occasional series of articles about the U.S. Army Engineer Research and Development Center's support to multidomain operations.*

**W**hen military leaders refine battle plans and prepare for multidomain operations, they must have access to robust geospatial and environmental information about their operational area. Army leaders highlighted the critical need for a common operating picture in the document outlining the Army's operations concept, calling it one of the two "most important technical shortfalls" in its capability to achieve joint convergence. "The U.S. Army in Multi-Domain Operations 2028" stresses the importance of a shared visualization and decision support tool available to commanders in any service and at any echelon.

The multidomain operations concept requires a changed paradigm in the way actionable geospatial and environmental information is used. Digital maps alone will not suffice. Instead, the underlying common operating environment must allow commanders to access relevant terrain, weather and environmental information. Emerging geospatial capabilities now enable commanders to visualize the common operating picture in four dimensions—a full three-dimensional view plus the dimension of time. Actionable geo-information and decision tools must empower the planning of command-and-control activities at the appropriate level. Geospatial and environmental information and implementation concepts have matured and can now be incorporated into the common operating environment. The convergence of the complex, previously stovepiped systems now fosters interoperability, automation, resilience, robust analysis and speed.

Terrain, weather and other battlefield environmental effects fundamentally inform planning, situational awareness and the decision-making processes within the mission

command warfighter function. These conditions each impact force tactics and behaviors, platform performance (ground and air), system performance (e.g., sensors) and the Soldier. For example, in planning converging strike capabilities across multidomain formations, planning teams require precision and exquisite knowledge of the terrain, weather and environment, tailored to how they may impact potential courses of action. Calibrating force posture and maneuvering multidomain formations into tactical areas heavily protected by enemy anti-access and area-denial systems requires similar information, readily available for decision-making across echelons and the joint services.

The U.S. Army Engineer Research and Development Center (ERDC) is DOD's lead in research on terrain and the Army's key to geospatially enabling mission planning and mission command, and is home to the only DOD laboratory whose sole mission is environmental research. As such, the center is fully engaged in research to meet the needs of multidomain operations. Its geospatial and environmental expertise and technologies help the warfighter understand the terrain and the operational environment across a range of users and platforms to support key decisions affecting mission command, maneuver, logistics, intelligence and fires. Key use cases include mission planning; determining and visualizing enemy capabilities; planning and visualizing weapons effects in a three-dimensional urban terrain; applying terrain analysis; optimizing intelligence, surveillance and reconnaissance planning; and supporting movement and maneuver in complex terrain.

The center has transitioned several major programs to meet the need for a new generation of actionable geospatial and operational environment information, and it has plans to transition more.

**MORE THAN A MAP**

Existing planning tools do not allow operational leaders to communicate a commander's intent, operational purpose and desired end state during rapidly changing operations. Recognizing this, ERDC developed a digital, geospatially enabled planning environment that provides multiple forms of collaboration within the tactical, operational and strategic communities.

Map-Based Mission Planning is a joint research program that enables the sharing of ideas and situational understanding between superiors, subordinates and peers in all phases of military planning processes. Its geospatially enabled capabilities allow planners to collect, process and share information and make informed decisions in near-real time.

Analyzing the effects of weather, terrain and even urban-area concerns, the program continuously gathers logistics, intelligence and operational information to support decision-making by utilizing authoritative databases. It provides an updatable and interactive common map to be used by leaders, and it can flag hazards, such as terrain likely to flood during a certain time of year or routes that take Soldiers through hazardous-material areas, to reduce maneuverability risks.

The program enables all elements of the force to operate on the same map and supports real-time coordination and collaboration.

**IT LOOKS LIKE RAIN**

ERDC has developed a variety of environmental modeling platforms and intelligence tools designed to support the planning process and be integrated into the toolbox of the common operating environment.

Weather impacts how commanders select objectives and how they locate, move and control forces. Poor weather can significantly diminish Soldier and weapon system performance. Yet, the Army faces a challenge to integrate weather with geospatial services or to fully understand how the weather impacts the terrain across

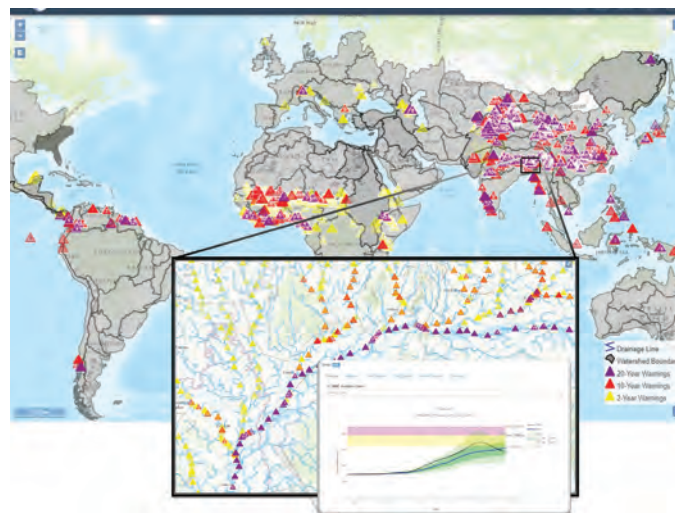

**DANGER OF FLOOD**

ERDC's Streamflow Prediction Tool produces 15-day continental-scale streamflow forecasts for each river, stream and tributary, including an intuitive warning system that highlights areas most likely to experience flooding. (Photo courtesy of U.S. Army ERDC)

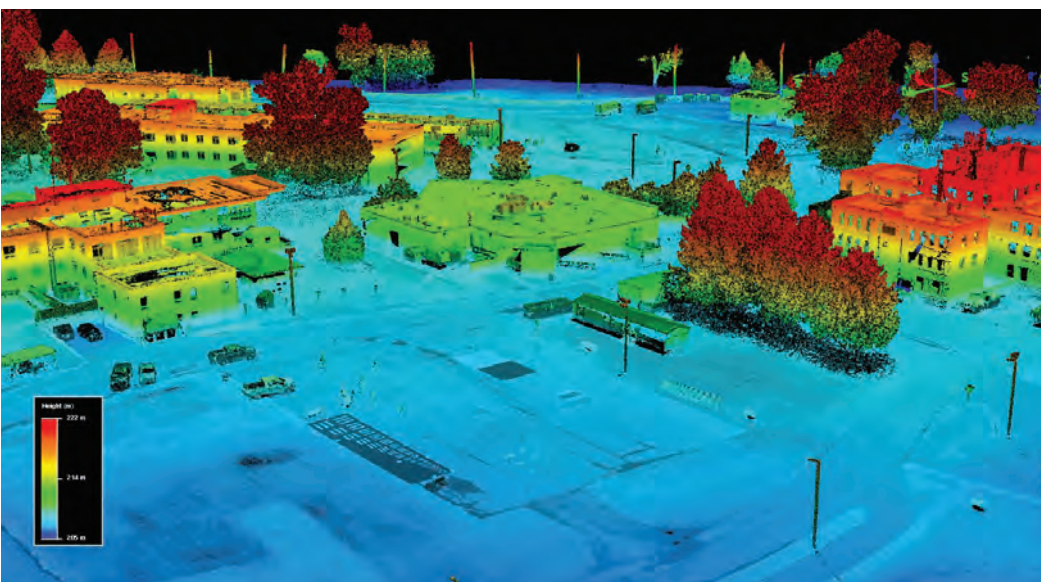

### LIDAR MAPPING

ERDC researchers built a 3D “point cloud” view of the Muscatatuck Urban Training Complex in southeast Indiana in December 2018. The point cloud derives from an overhead collection of airborne LIDAR data to establish a reference data set for 3D mapping of infrastructure. (Photo courtesy of U.S. Army ERDC)

functions and courses of action. ERDC researchers solve this difficulty by merging diverse core competencies across the center’s seven laboratories.

They have adapted the NASA Land Information System (LIS), a modeling software package, to generate a number of military geospatial and environmental products. The Army Terrestrial-Environmental Modeling and Intelligence System (ARTEMIS) transitioned technologies to the Army’s Distributed Common Ground Station, which directly supports mobility and maneuver planning, military hydrology, austere entry, geospatial awareness, and other battlespace-awareness and mission-planning capabilities. With the ability to mine vast amounts of land surface modeling data, weather forecasting

and climate models, ARTEMIS improves geospatial awareness of the changing environment at the tactical level, enhancing situational understanding and improving predictive capabilities. Example tools include Geospatial Tactical Route Analysis in Complex Environments (GeoTRACE), decision aids for lightweight dismounted operations to determine optimal routes based on factors such as minimal slope, shortest time, caloric expenditure or altitude impacts.

In 2019, ERDC began development of a tool to inform the Army of hazards such as toxic threats to the warfighter that must be avoided in mission planning. This tool, Understanding the Environment as a Threat, includes capability to locate industries, identify toxic industrial chemicals

and materials, and predict the threat in air, soil and water. The tool also will provide updated toxicity profiles and subterranean reverse-point adversary sourcing, while using a hazard-based weigh-risk routing option.

ERDC’s newly initiated Intelligent Environmental Battlespace Awareness project will allow the warfighter to better identify environmental terrain constraints and natural battlefield barriers. It will deliver improved understanding of soil, snow, ice and hydrological conditions.

In the latter part of 2020, ERDC will begin developing a sensor system that can detect and identify biological hazards in the environment, particularly those found in subterranean environments. The project, Sensing in Contested Environments, will integrate with standard Army robotic platforms, as well as the Instrument Set, Reconnaissance and Surveying system (commonly known as ENFIRE), to inform the common operating picture.

**Actionable geo-information and decision tools must empower the planning of command-and-control activities at the appropriate level.**



### WATER MOVEMENT

Staff officers from NATO's Allied Rapid Reaction Corps visit British Royal Engineers in Minden, northwestern Germany, as they prepare for river crossing drills in February. (Photo by British Army Sgt. Alistair Laidlaw)

ERDC's hydraulics expertise provides additional intelligence to mission planners. The robust Streamflow Prediction Tool produces 15-day continental-scale streamflow forecasts for each river, stream and tributary. This includes an intuitive warning system that highlights areas most likely to experience flooding based on the 15-day forecast.

The interactive map-based web interface is easy to access and understand, allowing planners to quickly gauge river crossings in any part of the world and determine whether an unusually

high waterway will disrupt the ability to execute a planned route. Ongoing collaboration with the United Kingdom Meteorological Office involves evaluating various land surface models to identify optimal configurations for estimating streamflow. This is a great example of how ERDC is able to apply technology developed in its civil works mission space to challenges faced by the military.

### THE URBAN TOOLKIT

The Army considers urban combat inevitable. Doctrine developers see it as a flowing series of tactical unit decisions and

actions, which will greatly benefit from rich and intuitive space, event and trend context. From the perspective of mission command, the multidomain-operations concept points to higher complexity, hyperactivity and faster, shorter engagements in all domains, including the electromagnetic spectrum and the information environment.

This implies the critical need to greatly accelerate commander decision time with shorter reaction windows, increased ability to deal with raw data and decreased processing staff time. Accordingly, ERDC, with its U.S. Army Combat Capabilities Development Command partners, has begun research into designing and formulating new urban terrain data models, frameworks and cognitive display approaches. These products will enable wide tactical distribution, sharing and analysis, while delivering the right level of detail across the common operating environment.

ERDC's Geospatial Intelligence and Complex Urban Environments technology is one example. It provides enhanced situational awareness and terrain analysis for dense urban environment operations. Technologies enable high-resolution 2D and 3D data collection on hand-held devices, including inputs from LIDAR (a surveying technology that measures distance by illuminating a target with a laser light) sensors to survey and map underground structures and building interiors, as well as to define complex urban environments. These technologies allow merging of high-altitude, low-altitude, surface and subsurface sensor data. They also have demonstrated low-cost unmanned sensors that allow rapid situational understanding in dense urban areas, in addition to tools that provide enhanced ground-based imaging for routine use.

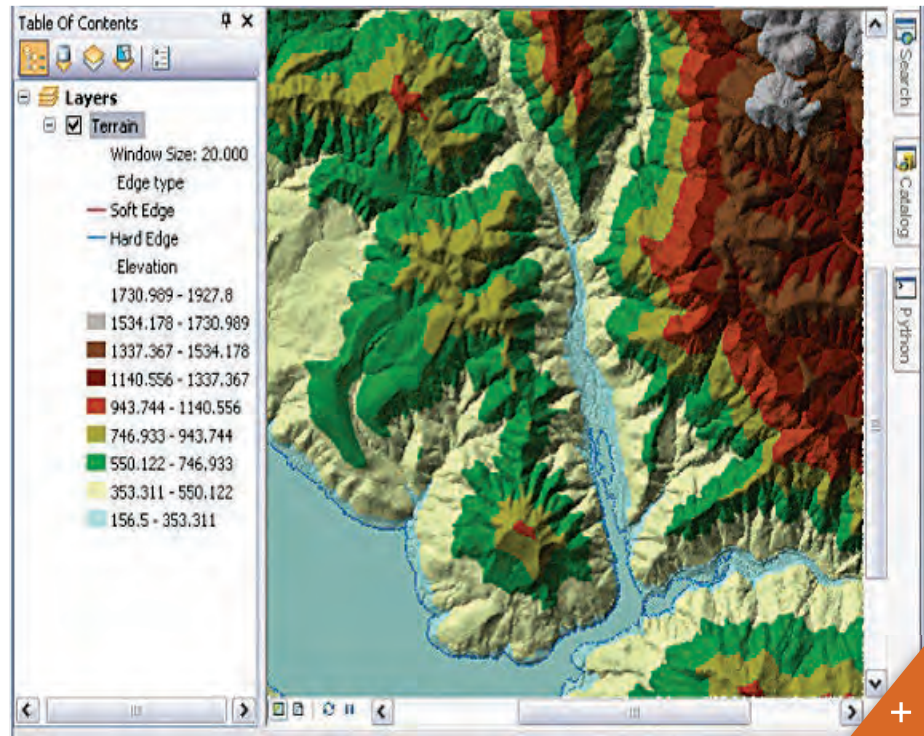

### ECO INSIGHT

In the multidomain-operations environment, the Army's freedom of maneuver will be limited by a lack of knowledge of natural environmental constraints. ERDC offers tools that integrate its geotechnical, hydrologic, environmental and cold regions expertise into high-fidelity geospatial overlays. (Photo courtesy of U.S. Army ERDC)

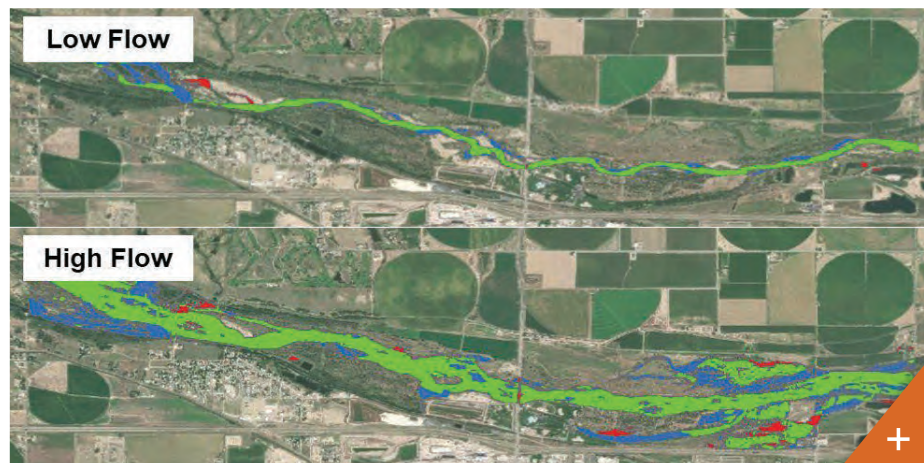

### TECH TRANSFER

ERDC's Streamflow Prediction Tool is a great example of how the center is able to apply technology developed in its civil works mission space to challenges faced by the military. (Photo courtesy of U.S. Army ERDC)



The Army faces a challenge to integrate weather with geospatial services or to fully understand how the weather impacts the terrain across functions and courses of action.

**ON THE SAME PAGE**

ERDC’s Map-Based Mission Planning program allows planners to collect, process and share information. It enables all elements of the force to operate on the same map and supports real-time coordination and collaboration. (Photo courtesy of U.S. Army ERDC)

Small units require specialized geospatial analysis tools for complex urban environments, such as ERDC’s Urban Landscape Terrain Reasoning and Analysis tool. It uses knowledge about Soldier equipment loads, terrain, roads and population density—as well as dynamic information such as enemy positions, local civilian behavior, weather and other factors. It enables units to rapidly plan unconventional missions in urban environments, providing new options to support small team movement in a true three-dimensional depiction of urban infrastructure displaying subterranean, interior and rooftop pathways.

**CONCLUSION**

Preparing for multidomain operations in areas that are heavily guarded by enemy anti-access and area-denial systems, or that are inherently complex, requires advanced knowledge of the terrain, weather and environmental factors specific to military operations. Analysis tools must inform mission planners’ options and alternative

courses of action. Deriving and delivering useful information from an increasing volume, variety and velocity of data will be critical to success in the anticipated complex operational environments.

With a long history of terrain and environmental expertise for the Army and DOD, ERDC stands ready to provide this information on a variety of platforms that can be easily accessed by mission leaders, from high-echelon planners to Soldiers in the field at the tactical edge. That information is strengthened by ERDC’s understanding of environmental factors and how they affect the terrain warfighters will encounter, as well as its ability to incorporate that knowledge into its geospatial tools.

For more information, contact [ERDCinfo@usace.army.mil](mailto:ERDCinfo@usace.army.mil).

To read the first in the series, go to: <https://asc.army.mil/web/news-alt-jfm20-engineering-the-theater/>.

*DR. ROBERT DAVIS is the chief scientist and senior scientific technical manager for Geospatial Research and Engineering and the technical director for Army programs at the Cold Regions Research and Engineering Laboratory, part of ERDC. He holds a Ph.D. in geography, an M.A. in geography and a B.A. in geology and geography.*

*WILLIAM JONES is an associate technical director at ERDC. He works to maximize the contribution of the built and natural environment to enable mission effectiveness and operational success from the Army’s installations to the battlefield. He is responsible for delivering advanced environmental and military installations technologies to the Department of the Army and the Soldier through basic and applied research and development. He received his master’s and his bachelor’s degrees from Mississippi College.*

# PLANNING FOR JOINT USE

| In a complex health care construction project,  
| good joint-use planning can speed occupancy.

*by Lt. Col. Edwin H. Rodríguez*

**T**he 1.13 million square-foot Fort Bliss Hospital Replacement Project in El Paso, Texas, is a military construction program intended to replace the 40-year-old William Beaumont Army Medical Center at a cost of \$1.3 billion. The project acquisition method used was the design-bid-build method, in which construction follows a complete design or 100 percent design effort. The six-building secure campus consists of a main hospital, outpatient clinics, administrative building, clinical investigation (research) facility, central utility plant, a visitor control center and two access control points. It is scheduled to be open Sept. 30.

This medical campus will have 10 operating rooms and 30 specialty clinics, including women's health services, behavioral health, physical and occupational therapy, gastroenterology, oncology, hematology, general surgery, family medicine, vascular surgery, plastic surgery and more. The project also will include a full array of imaging services, inpatient and outpatient pharmacy, laboratory, patient administration, logistics, dining facility, administration and limited retail. Additionally, it supports 15 graduate medical education, nursing and enlisted training programs. This facility was built to serve military members, their families and the local community of El Paso for the next four decades.

As the Fort Bliss Hospital Replacement Project was approaching its substantial completion phase, the U.S. Army Health Facility Planning Agency project office was looking for targets of opportunity before construction completion to expedite the initial outfitting and transition effort. Timing of this critical step depends on the general contractor and U.S. Army Corps of Engineers (USACE) construction contract completion, building commissioning

and other final closeout requirements. Along with these construction-related, time-intensive activities, hospital departmental equipment and personnel moves were also considered. An adaptable agreement for joint-use in overlapping acquisition activities serves as an essential and cost-effective tool to maximize collaboration and so reduce time and financial burdens to the program.

### WHAT IS A JOINT-USE PLAN?

A joint-use plan is an agreement designed by the most relevant stakeholders, including the U.S. Army Health Facility Planning Agency; VWI International, the initial outfitting and transition contractor; USACE; Clark McCarthy Health Partners II, the general contractor; and William Beaumont Army Medical Center. This agreement is meant to ensure constant coordination of activities in overlapping areas of occupancy and responsibility. It also ensures that during joint-use, the costs for the construction project and the associated initial outfitting and transition activities are minimized. Furthermore, the work needs to be performed safely with no degradation of quality and without disruption of project timelines.

### SHAPING THE JOINT USE PROJECT DELIVERY TEAM

The success of every project is driven by the talent and collaboration of its team members. It is measured by having each stakeholder's role well defined in advance to set clear understanding of their responsibilities. Following are the most relevant stakeholders in the Fort Bliss Hospital Replacement Project and their associated duties.

**Program manager, owner and customer.** Program manager is represented by the local program office, working in a dual capacity for both the Health Facility Planning Agency and the Defense Health

Agency (DHA) during the design and construction stages of the project. The program office represents the U.S. Army Office of the Surgeon General's interests and intent in support of local commanders with program life cycle facilitation, coordination, initial outfitting and transition, and oversight of capital investment strategies and initiatives.

**This facility was built to serve military members, their families and the local community of El Paso for the next four decades.**

**Construction manager and contracting agent.** Represented by USACE Fort Worth District as the contractual design and construction authority for the government. The district contracting officer or the authorized administrative contracting officer within their appointed authority is the only individual authorized to direct changes to the design or construction contracts.

**General contractor.** Represented by Clark McCarthy Health Partners II as the firm awarded construction contracts, the general contractor is responsible for providing a quality construction product

in accordance with the approved contract documents.

**Initial outfitting and transition contractor.** Represented by VWI International, which supports the U.S. Army Health Facility Planning Agency in providing total turnkey effort. This type of effort often involves the provision of a complete product or service that is ready for immediate use by the end user or owner. VWI provides initial outfitting support with services such as cradle-to-grave project management, medical equipment planning, comprehensive interior design, artwork, signage, resource protection, information technology, communication systems, procurement, warehousing, delivery, installation, inventory and warranty support that can provide everything needed to meet the mission on the first patient day. Also, VWI offers transition and clinical operation planning services designed to ensure smooth processes to support the patient delivery model.

**End user.** Represented by William Beaumont Army Medical Center, which is responsible for organizing a transition committee; determining transition funding; manpower, equipment and training needs; and creating an atmosphere of constructive, enthusiastic involvement in the completion and activation of the new medical center.

### WHY JOINT-USE?

Overall, joint-use decreases facility operational cost and minimizes equipment and supply variation while decreasing product consumption and inventory, streamlines staff training and creates opportunity for future cost avoidance and savings. There are benefits from reducing project lead times without sacrificing project content. This adds additional project capacity that will allow the program manager to concentrate on other areas that may require more



attention because of their complexity. For such, gaining an understanding of a phased acquisition and delivery process is crucial when early occupancy is needed before the completion of construction and project closeout.

To complete such a task, a phased occupancy plan or a formal joint-use plan is required. The joint-use plan is an agreement co-developed between the general

contractor and a government organization or its agent that addresses the period before handover or the beneficial occupancy date. Beneficial occupancy date is the date the customer can expect to receive useful occupancy of the facility or construction work ends for the general contractor. The owner may need to continue administering the final stages of the project construction contract until such completion, and the user may begin

to occupy all or agreed-upon parts of the facility and use it for its intended purpose.

The general contractor maintains full and proper control of and responsibility for the operations and security of the facility. Before the beneficial occupancy date, the general contractor “owns” the building while it is under construction and before the government accepts it. During acquisition, especially for a complex medical

## DESIGNING A JOINT-USE PLAN



### POWER

Contractors will provide their own protective equipment to prevent damage from using power receptacles.



### DEBRIS REMOVAL

Each user will be responsible for daily removal of their own trash, debris and recyclables during the joint-use period, on all areas of the campus. Stakeholders will monitor and enforce this guidance for all contractors, for fire safety and health standards.

The general contractor and its subcontractors will provide trash and recycling removal containers, until their work is complete. The initial outfitting and transition contractor will assume this responsibility by the fully operational date.



### WATER

Water is not considered potable until medical center staff perform water quality testing near the project's end.



### CLEANING

Housekeeping will conduct routine cleaning of all surfaces, in compliance with standards of the Occupational Safety and Health Administration, the Centers for Disease Control and Prevention, and the Joint Commission.

During the joint occupancy agreement period, the medical center should have an environmental care contract in place to ensure that each area is ready to receive furniture, sensitive IT equipment and medical equipment as needed, in accordance with guidelines.



### DUMPSTER REMOVAL

The general contractor will provide trash and recyclable removal services until construction is complete. The initial outfitting and transition contractor will then assume responsibility for trash and recyclable removal until the fully operational date.



### KEYING ACTIVITIES

The medical facility's management division and security team will coordinate the schedule and submit the work request through the designated contractor for the key core installation. The contractor will work with the locksmith to determine functions.

## CONSTRUCTION PHASE

Inspections for phases that don't require occupancy before project completion will be done the same way as any other non-phased construction. Minimum acceptance criteria are necessary to begin furniture and equipment installation. USACE will allow medical center inspections for equipment installation during the joint-use plan, taking into consideration the existing punch list items. A punch list is a list of work or items that require revision or repair to meet contract specifications.

The initial outfitting and transition contractor must ensure that all surfaces are protected, to prevent or minimize damage during outfitting. Otherwise, it must correct any additional damages that occur during outfitting.



## MINIMAL ACCEPTANCE CRITERIA

Basic requirements that must be fulfilled before installation of furnishings and sensitive equipment can begin.

- **HOUSEKEEPING** — Designate operational restrooms in the facility and ensure that there is a dust-free environment in and around all rooms before installation.
- **CRITICAL ITEMS** — All HVAC (heating, ventilation and air conditioning), including temporary positive pressure, must be installed and operational to meet the specifications for sensitive equipment. Elevators must be certified and operational.
- **POWER VOLTAGE AND COOLING** — All contractor supplied cables must be pulled and terminated. Test results will be submitted and approved, and the data center and communications closets must be using permanent, fully commissioned cooling systems.
- **LIFE SAFETY** — All stair enclosure shafts must be completed, with permanent handrails, balustrades and guards installed. Fire extinguishers must be in place and construction material removed from the site.

## EQUIPMENT PLACEMENT COORDINATION

A critical part of joint-use planning is identifying equipment lease agreements, direct supply deliveries and warranty agreements. Once they are identified, establish dates to move or terminate those services, so that all agreements can be re-established at the new facility.

## OPEN ITEMS

The building turnover process will continue with the completion of all remaining punch list items, seasonal commissioning and monthly closeout meetings with major stakeholders. Turnover also includes integration into the facility management program, which is a cooperative effort between the medical facility management division and the operational and maintenance engineering enhancement contractor to ensure the continued care of the building.

facility, many types of equipment require extensive coordination for their delivery and installation prior to beneficial occupancy date. Access, schedule, supervision, custody, safety, security, utility provision, mechanical system access and space use, among other items, must be aligned to avoid conflict. The joint-use plan is developed to ensure that the entire facility can be made operational on schedule and that the total time and cost to the owner is minimized for the military construction project and for the associated fit-up. The general contractor will ensure that all identified joint-use spaces meet minimum acceptance criteria, defined via coordination with the owner prior to outfitting.

#### VALUE ADDED

The joint-use plan document provides all parties a foundational understanding about how a project is being phased as part of a strategic delivery process. This is essential for larger projects with equipment items requiring long lead times and extensive access and utility coordination. The value of planned coordination is for all parties to understand the conditions of project phasing, the physical state of project completion, any special permitting or inspections necessary, documentation needed for fire and life safety and other health concerns necessary for a successful joint-use plan for those designated areas. For all other associated parties and other vendors involved with the project, the joint-use plan serves as the tool to determine how to meet the general contractor's

and owner's ordinances and policies and to properly plug into the project phasing strategy.

#### APPLYING LESSONS LEARNED

The program office has been gathering lessons learned from various projects in different stages of construction and transition to take corrective action that has been of increased value during the joint-use coordination effort. The program office has drawn lessons from the repository compiled by USACE and the U.S. Army Health Facility Planning Agency. These documents serve as best practices for medical projects during their initial outfitting and transition period.

#### DESIGNING A JOINT-USE PLAN

When planning your project, it is important to involve the end user and the owner as early as possible so that all parties understand the phasing strategy for both construction and occupancy. Typically, this is done by the project delivery team (architect, engineer, government representatives, agent and contractor). This process is iterative as acquisition proceeds. The initial meeting is most productive when plan-review staff and project manager inspection teams are involved, further assuring all parties understand the concept and execution of the phasing plan.

#### CONCLUSION

Understanding the potential risks and cost overruns associated with transitioning

into a new facility can enable the owning organizations to effectively and predictably plan for smooth transitions from construction to operational readiness. Risk mitigation also affects long-term asset management by contributing to lower operation and maintenance costs, increased facility longevity and a superior customer or occupant experience.

With an increase in the level of technology in facilities coming online in the near future, it is imperative that the transition planning, workforce preparation and data transference are consistent and reliable for organizations expanding their portfolio and seeking an integrated operation and asset management program from opening day of a new facility. By designing and implementing a carefully constructed and implemented joint-use plan, risks to the owner, agent and the project delivery team are minimized.

---

*LT. COL. EDWIN H. RODRIGUEZ is the program manager for the Fort Bliss Hospital Replacement Project. He has an M.A. in health service management from Webster University and a B.S. in biology from Universidad Interamericana de Puerto Rico. He is health facility planner, supply chain manager and a Lean Six Sigma Green Belt. He is a graduate of Army Command and General Staff College, the Health Facility Planning Agency internship program and the Army Medical Materiel Management internship program.*

**Joint-use decreases facility operational cost, minimizes equipment and supply variation while decreasing product consumption and inventory, streamlines staff training and creates opportunity for savings.**

## LIKE A CHEETAH

Mullins recruited prosthetic maker Van Phillips to help develop new prostheses for her sports career. He employed material engineers to invent the "cheetah leg," woven carbon-fiber prostheses that were modeled after the hind legs of a cheetah. It became the prototype of the standard prostheses used now by all amputee runners. (Photo by Howard Schatz, Schatz Ornstein Studio)



# DREAMS OF FLIGHT

Being born without fibulae didn't stop Aimee Mullins; neither will expectations, competition, sexism or anything else.

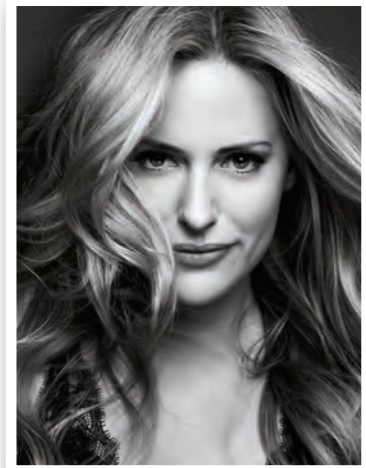

Aimee Mullins

*by Michael Bold*

**W**hen California Gov. Gavin Newsom issued his shelter-in-place order in mid-March, athlete/innovator/model/actress/advocate Aimee Mullins and her husband, English actor Rupert Friend, were in Los Angeles working on a project that she would produce and he would direct. They couldn't get back to their apartment in New York, so a friend offered them a cabin on a 400-acre ranch north of Los Angeles, and they've been there since.

On the day in mid-April that Army AL&T spoke with her, Mullins had spent the morning daydreaming that she was a hawk, flying over the valley and the mountains that surround her temporary home. "I used to have a recurring dream like that when I was a little girl," she said. "And again, you know, you don't have to be a licensed psychologist to kind of figure that one out. When you're in a hospital bed and your legs are in full plaster casts and stuff, the idea of flying ..."

Mullins was born without fibulae, one of the bones in the bottom half of the leg. Her doctors in Allentown, Pennsylvania, told her parents that she would never walk and that her life would be spent in a wheelchair. At age 1, doctors said she might have a chance at mobility using prosthetics. Her legs were amputated below her knees. She quickly adjusted to her prosthetic legs, walking by age 2. More surgeries followed until she was 8. Then it was on to a childhood of swimming, skiing, biking, softball and soccer.

**"I'd like you to remember that naiveté, curiosity and daydreaming are tools for building a better life, and you should be reaching into your toolbox for them often."**

She graduated high school with honors and then won a full scholarship sponsored by DOD in Washington, D.C., graduating from the School of Foreign Service at Georgetown University. Mullins worked four summers as an intelligence analyst intern at the Pentagon, holding a top-secret security clearance.

### AN ATHLETIC TURN

She learned two major lessons at the Pentagon. The first was about hard work. She'd had jobs since she was 12—paper route, frozen yogurt shop, babysitting, mowing lawns—but at the Pentagon, she learned how long a workday could last. "I remember thinking as a teenager, 'Wow. If I even spent half this time every day on schoolwork, I'd be like a genius.' It was the kind of thing where it really made me value time. It also made me understand something about myself, which was that I am a self-starter, like a leader. I like teams. I like to play on a team."

The second lesson she learned was that she chafed under bureaucracy. "There are certain elements of bureaucracy which are necessary to run an organization that huge, but some of them really didn't—it didn't make me happy. ... I just knew, wow, I've got to do something else with my life."

Her scholarship included a five-year commitment to DOD, but "my life took such a different turn, so I paid the whole thing back with interest."

That different turn began her sophomore year at Georgetown, when someone suggested to the very active Mullins that she participate in the National Disabled Sports Championships in Boston. At first the idea didn't appeal to her—it seemed like an exercise in building self-esteem, which she didn't lack. But she decided to give it a try. To prepare, she went to



### LEGS FOR ALL OCCASIONS

Among her other accomplishments, Mullins has accumulated an impressive collection of prostheses—some of them incredibly realistic. There's a pair for 1-, 2- and 3-inch heels, each requiring different angles between the leg and foot. (Photo by Kenneth Willardt, L'Oréal)

a nearby track, where someone had to explain to her that the 100 meters was the part of the track that was the straightaway. Her first effort left her exhausted after 50 meters. A couple more tries, though, and she felt ready. By this point, she had only met one other amputee in her life.

She arrived in Boston to find a world she never knew existed. Athletes wearing carbon-graphite-rubber composite prosthetics were competing in every event. Her clumsy, wood-plastic composite legs appeared to be no match, but she ran the 100-meter sprint anyway. And beat the American record holder. With a new American record.

Then she decided to compete in the long jump—after learning no women were signed up for the long jump, she saw another 1st place medal was there for the taking. While waiting her turn to jump, a fellow athlete pointed out that as a BKDA—below-knee double amputee—she wasn't supposed to long jump. All long jumpers needed one flesh-and-bone leg to use as their plant leg. "Well, nobody told me that, and I've already jumped twice, so I might as well keep doing it," she recalled in her commencement address to Northeastern University graduates in 2018.

When Mullins returned to Washington, she called legendary Georgetown track

## The cheetah leg became the prototype of the standard prostheses used now by all amputee runners.



### LONDON CALLING

Mullins had special legs made for the opening of the 2012 London Olympics, where she was the U.S. chef de mission. The gold laurel leaf winged pattern was designed by Betony Vernon and then fabricated by Bob Watts and his team at Dorset Orthopaedic in Ringwood, England. They had to figure out how to get metallic pigment to stabilize within silicone without it losing its metallic quality. (Photo courtesy of Aimee Mullins)

### AIMEE MULLINS' HONORS

- Past president and current trustee of the Women's Sports Foundation.
- Served four years as vice president of the nation's oldest nonprofit employment service for people with disabilities, Just One Break. She was the first woman on the board since the organization was founded in 1947 by Eleanor Roosevelt.
- Appointed to the State Department's Council to Empower Women and Girls Through Sports.
- Honored by the Smithsonian, the Metropolitan Museum of Art, the NCAA Hall of Fame, the Victoria and Albert Museum and the Tate Modern museum, both in London, and the Track and Field Hall of Fame. The Women's Museum recognized her among the "Greatest American Women of the 20th Century," and in 2017 she became one of the youngest inductees to the National Women's Hall of Fame.
- Was appointed chef de mission for the United States at the 2012 Summer Olympics and 2012 Summer Paralympics in London.

coach Frank "Gags" Gagliano, asking for a spot on the track team. Gagliano had never coached an athlete with a disability before; Mullins had never been coached. But he admired her nerve, and Mullins became the first woman with a disability to compete in track and field at the NCAA Division I level, entirely against able-bodied athletes.

Her next goal was to compete on the United States team at the 1996 Paralympic Games in Atlanta. But she realized her old-fashioned prosthetics wouldn't cut it. Rather than basing a prosthetic on a human leg, "I want to be the fastest women on prosthetics in the world. Why aren't we looking at the fastest thing that runs if I don't have to have a shin and a foot below this knee?" she said in the interview with Army AL&T.

"That was always a big problem," she said. "It's like a shin and a foot, it's going to be a fixed 90-degree angle. No matter how great your stride length or whatever, you're always re-striking with that heel, and it's a clunky way to run."

She enlisted the help of a visionary prosthetic maker, Van Phillips, who employed material engineers to invent the "cheetah leg," a woven carbon-fiber prosthesis modeled after the hind legs of a cheetah, the fastest animal on land. As a human guinea pig, Mullins was the first person to test them and get them to a place where they worked well enough for her to wear them to compete. The cheetah leg became the prototype of the standard prostheses used now by all amputee runners.

Heading into the Atlanta Paralympics, Mullins held national records in the

100- and 200-meter sprints and in the long jump. She expected to win in Atlanta. But 20 minutes before the 100, she saw her competitors' times in the time trials—all at least two seconds faster than hers. When she stepped onto the bus that would take her and her fellow competitors to the Olympic Stadium, she understood why. All of her competitors were missing hands. She was the only competitor on prosthetic legs. She came in last.

That was not the first time, nor was it the last, that Mullins faced adversity.



### OLYMPIC EFFORT

Mullins finishes the 100-meter dash at the 1996 Paralympics in Atlanta. She was the only competitor with even one amputated leg. She came in last. (Photo by Phil Cole, ALLSPORT)

## Mullins became the first woman with a disability to compete in track and field at the NCAA Division I level, entirely against able-bodied athletes.

### CHANGING AN IMAGE

“Adversity in general is just a natural part of life,” she said. “We have words like ‘speed bumps’ and ‘hurdles’ and other words which help people visualize challenges—however we choose to see them, just know that they’re coming. And that’s OK. The waves of challenges will keep coming, so let’s get better at surfing.”

But Mullins had caught people’s notice. After profiles in several magazine and TV news shows, Mullins began speaking at international design conferences. Her discussions of changing the way we think about disabilities, body image and beauty attracted the attention of renowned fashion designer Alexander McQueen, who in 1998 put her on a London runway—in 6-inch heels on handcarved wooden “boot” prosthetics—with supermodels from around the world. She signed a contract to become the face of L’Oréal Paris, the largest cosmetics company in the world.

More press followed—Vogue, Harper’s Bazaar, W, Glamour, Elle. She was named one of People magazine’s “50 Most Beautiful People in the World” and celebrated as one of Sports Illustrated’s “Coolest Girls in Sports.”

“There was no template for me,” she said. “There was no trail that I could follow, no amputees in sports, fashion, the arts, you name it.”

But it was her TED Talks that really electrified her growing audience. She is one of TED’s most popular speakers and was named a TED All-Star. Her talks have been translated into 41 languages and have been seen by millions of viewers worldwide.

She did her first in 1998, at age 21, trying on different pairs of legs for the audience. In February 2009 she talked about “My 12 Pairs of Legs.” And then there’s her devastating October 2009 talk, where she reads the synonyms for “disabled” found in her 1982 Webster’s New World Thesaurus: crippled, helpless, useless, wrecked, stalled, maimed, wounded, mangled, lame, mutilated, run-down, worn-out, weakened, impotent, castrated, paralyzed, senile, decrepit, laid-up, done up, done for, done in, cracked up, counted out. See also hurt, useless, weak.

In the meantime, she became an actress—“I started acting professionally when I was 27, which is like you may as well be 90.” She is in the cast of the Emmy Award-winning Netflix series “Stranger Things” (she’s Eleven’s mother).

In 2018 she delivered the graduation commencement address at Northeastern University in Boston and received an honorary doctorate. “Oh, that was such a—you know, really only the second time in my speaking career where it’s been 20,000-plus staring back at you,” she said.



**RUNNING A CAMPAIGN**

Mullins' influence helped change the way we think about disabilities, body image and beauty. In 1998, she signed a contract to become the face of L'Oréal Paris, the largest cosmetics company in the world. (Photo by Kenneth Willardt, L'Oréal)



“You don’t forget those.” (Full disclosure: The author’s daughter was among those graduating.)

Her message to the grads was that they should embrace what many would call shortcomings. “I’d like you to remember that naiveté, curiosity and daydreaming are tools for building a better life, and you should be reaching into your toolbox for them often,” she told them.

**PAVING THE WAY**

Curiosity and daydreaming sparked her imagination, she told Army AL&T, along with pop culture. “Stan Winston built the Terminator. It has an articulated ankle and knee, and I was seeing it. I was seeing these things happening in pop culture that just felt like, ‘Why isn’t that being used for people who need to have legs built, or arms?’”

“There’s been an extraordinary evolution in the last two decades in the field of prosthetics, not least because of ... the research

dollars for all of our veterans of the wars of the last decades that have come back with changed bodies.” Nearly all of the Soldiers were familiar with video and computer games, she noted. “So the idea of having an avatar, the idea of imagining yourself as another being moving through a world, was a muscle they had been flexing their whole life. They never stopped it. ... I think veterans from Afghanistan, Iraq, the Persian Gulf War, they were very adaptable to their new bodies. You see people absolutely claiming their changed body; they can remain athletic and they also assert their creative power to make their prostheses the aesthetic representation of what they want their leg or their arm to look like.

“I see that with kids, when you meet 5-year-olds who, for whatever reason, become an amputee. I met this girl at South by Southwest, and she created an arm that had a glitter rocket mechanism. It had this internal slingshot, and she could kind of raise her arm toward the sky and pull this little lever mechanism, and glitter would come flying out. It made her the belle of the ball! She was 6 or 7 when she came up with this.”

And her naiveté? “If you call someone naïve, it’s usually not a compliment.” But it was naiveté that allowed her to think anything was possible, even for a girl missing half her legs. She credits her large family, especially the women.

“My mom is one of 11 kids, nine girls and two boys,” she said. “There were many great things about having that kind of an army of family around. But one of the best things is this extraordinary network of women, very matriarchal. My grandmother was the head of the gang. She was 96 when she died, and just an extraordinary—you know, that generation of people just lived—she saw horse-pulled carts and she saw somebody land on the moon. So the competition that I think a lot of young girls grow up with, that they see amongst women, I never had that. ... The fact with

our family—my mom and her sisters, it was like they really pooled their resources. Any victory for one of them was a victory for all of us.”

Did she ever feel discouraged, or picked on by other kids or their parents? That she shouldn’t be on the same playing field as “normal” kids?

“I think they said it more to my parents. ... I really didn’t hear it. I just was not going to let anybody tell me what I couldn’t physically do. I really believed in my own capability. It was something—I think it was because my parents didn’t shelter me from people staring, pointing, making fun of, that kind of stuff. They really made me fight those battles on my own, and I had to learn how to stand up for myself from the get-go.”

Her mother, in fact, was a Franciscan nun for five years, leaving the order just before she would have taken her final vows. But giving up all her worldly possessions and taking a vow of poverty did leave some gaps in her daughter’s life. Her mother “definitely missed the ’60s,” Mullins said. “Like, the only album we had in our house, we had Simon & Garfunkel and we had like an eight-track tape of Helen Reddy. I was like, ‘This sucks.’ My friends had the Beatles. The Stones. Zeppelin. My parents had none of that.

“But one of the really good aspects of that is that she really had no vanity, my mom. ... I remember when people would kind of vocally notice somebody’s body part. ‘You have really nice shoulders,’ or, ‘You have really nice whatever.’ There was something about someone’s feet, ‘Oh, they’ve got beautiful feet.’ I was like, ‘What do ugly feet look like?’ I mean, in my case, ‘Hey, you’ve got feet!’ ... I feel very, very, very fortunate that my mom did not size me aesthetically, and I do think a huge foundation of me being confident comes from that.”

As she’s moved from athlete to innovator to model to actress to Hollywood producer, what has given her the greatest adversity: her physical disability or being a woman in a business run mostly by men?

“In my life thus far, I would say the first half, it would have been definitely the physical disability, if you want to call it that. But, man, I’ll tell you. As a working actor. ... For decades, for a century of moviemaking, most women’s roles were just ancillary to tell the story of the men.” She tells of a meeting for the production she’s working on, that her husband will direct. They’d given the studio executives the names of the actors they wanted to play the male and female leads. The



**BE CURIOUS; START SOMETHING**

“You do better just starting something than you do thinking about starting something,” Mullins told graduates at Northeastern University, Boston, in 2018. (Photo by Billie Weiss, Northeastern University)



### CLEARLY A WINNER

Mullins after she completed a Spartan Race in Massachusetts in 2012. (Photo courtesy of Aimee Mullins)

executives balked at the female lead, concerned she was too old. “She was two years younger than the male!”

“When you’re an actor, you’re never privy to these conversations, because they don’t say that to your face. When you’re on the other side and you get to make these decisions because this is how you get financing for your projects, it is galling to see how women are talked about.”

### CONCLUSION

In addition to her Hollywood career, Mullins works with a number of women’s organizations, including the Women’s Sports Foundation, founded in 1974 by tennis great Billie Jean King. Mullins served as president from 2007 to 2009, and remains a trustee.

“It’s galvanizing to see that we do, in society, value our daughters, and that’s been the most extraordinary thing in my work with the Women’s Sports Foundation,” she said. “We have the first generation of dads now who grew up under Title IX. They’re dads with daughters, and they call the foundation because they’re horrified that their son gets a brand-new uniform for baseball from the school budget and plays on a beautifully manicured field, while their daughter has to have bake sales and car washes to raise money for her new uniform, and gets the lesser-quality playing field. They’re shocked and upset that their

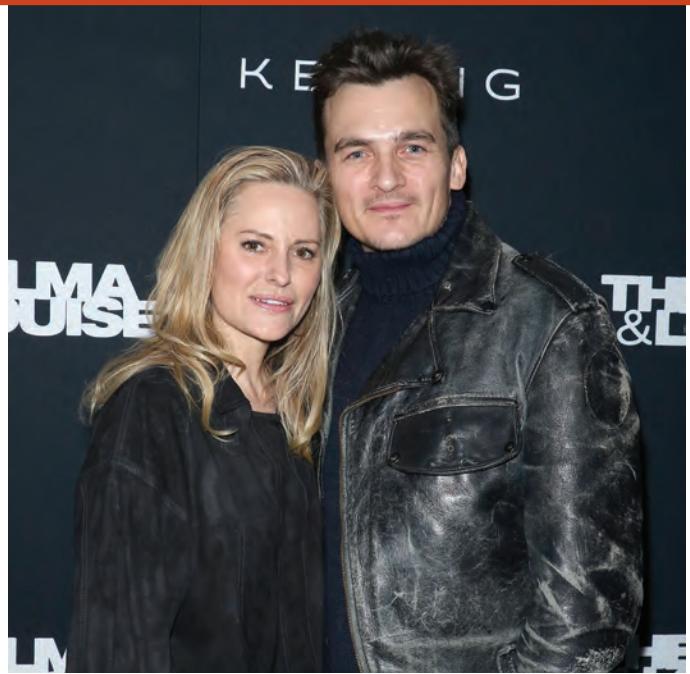

### WOMAN IN MOTION

Mullins and her husband, actor Rupert Friend, attend the Museum of Modern Art’s Women in Motion screening of “Thelma & Louise” on Jan. 28 in New York. (Photo by Jim Spellman, Getty Images)

daughters would get less funds from the institutions that they pay their tax dollars to than their son does. And so we see the needle move much more quickly when it’s not just women raising their hand saying, ‘Hey, this isn’t fair,’ but when you have everyone in society saying, ‘Hey, this isn’t fair.’ ”

In one of her TED Talks, Mullins said that, perhaps now, she didn’t wish that she’d been born with complete legs.

“If you’d asked me when I was 15 if I wanted to exchange my prostheses for legs of flesh and bone, I wouldn’t have hesitated for a second. But if you were to ask me today, I’m not so sure. And this isn’t despite the experiences I’ve had with my legs, but thanks to them.”

*For more information, contact the author at [mbold@networkrunners.com](mailto:mbold@networkrunners.com).*

---

*MICHAEL BOLD provides contract support to the U.S. Army Acquisition Support Center. He is a writer-editor for Network Runners Inc., with more than 30 years of editing experience at newspapers, including the McClatchy Washington Bureau, The Sacramento Bee, the San Jose Mercury News, the Dallas Morning News and the Fort Worth Star-Telegram. He holds a Bachelor of Journalism from the University of Missouri.*



### FUSION FOR GOOD

The Army National Guard's COVID-19 response efforts highlighted the need for a broader AI tool—something that could fuse data between two domains, reconciling semantic reasoning. (Image by Getty Images/Andrey Suslov)

# THE DROIDS YOU'RE LOOKING FOR

To make effective use of AI, the Army first needs a solid foundation of comprehensive data exchange standards and a thorough ontology framework.

*by Thom Hawkins and Ken Lorentzen*

Tell someone you're working on artificial intelligence (AI) for the Department of Defense, and there's one cultural reference point they're likely to mention—the “Terminator” franchise. As the story goes (and despite all of the movies in the series, it never gets particularly specific), robots advance sufficiently to gain consciousness and attack their human creators. “Killer robots?” they'll ask, as if that's exactly what you just claimed you do for a living.

It's easy to get excited about AI because we now encounter it on a daily basis. Amazon has sold more than 100 million Alexa-enabled devices. We share the road with at least a few self-driving cars, and many more now park themselves. Netflix Inc. has more than 150 million subscribers, a result, in part, of the attraction of outside content. But Netflix increasingly produces its own content and matches subscribers to it via its recommendation engine. AI sure looks like magic, and is often referred to as such, with equal parts admiration and skepticism, as in the commonly heard phrase, “we'll sprinkle some AI magic on this.”

Working with the nuts and bolts of defense data, though, it's easy to see why Cyberdyne Systems, the developer of the AI entity in “Terminator,” would not have imagined that they were building toward something that would one day take over the world. Our data collection is inconsistent, storage is decentralized and standards vary from system to system. The Army's recent data strategy addresses the importance of data to the military's future and focuses on making data visible, accessible, understandable, trusted, interoperable and secure—though we're still coming to grips with the implications of each of those factors.

Our systems-development approach has long been based on the notion that we should express a desired capability and give industry maximum flexibility to identify solutions. This is the method we're using now in the pursuit of “narrow AI”—an application that provides a well-defined but limited capability. For example, software that determines when you're likely to need resupply for a vehicle fleet based on user-entered usage rates. Narrow AI is unlikely to surprise or delight us with ingenuity.



### HEATING UP

Experience tells people that a gas burner and a beaker are perfect for heating a liquid, but computers need more context. An ontology will help provide that. (Image by Getty Images/Ian Logan)

The need for a broader AI tool was highlighted by the Army National Guard's efforts to support the national COVID-19 response. The question of how to ensure that supplies got to a defined point of need was complicated by the spread of the virus, which reprioritized needs as new clusters emerged. Before we could align the supply chain for personal protective equipment or ventilators, we needed to know which hospital would require those supplies based on the spread of the virus.

Integrating, or fusing, data between two domains—for example, logistics and medicine—is a challenge, not only because those domains have specialized vocabularies, but also because they have different concepts. For fusion, we need a structure that can reconcile conceptual or semantic reasoning—both what something is, as well as how it relates to other things.

For the logistics community, a ventilator is a piece of equipment that is manufactured, stored, maintained and shipped. In the medical profession, a ventilator requires power, has a setting for oxygen level, is assigned to one patient at a time and may require certain medications for intubation. Knowing how best to get a machine from point A to point B is only part of the problem. A ventilator only represents a life saved if it arrives on time for a patient and the facility has the other elements required for its successful use.

Data standards, that is, how data elements are defined and formatted, do not alone provide sufficient architecture for data fusion. For fusion, we need a structure that can reconcile conceptual or semantic reasoning in addition to allowing us to seamlessly send data between systems.

### IT'S ALL ABOUT RELATIONSHIPS

The term “machine-understandable” harkens back to Skynet and killer robots—after all, if machines develop understanding, they must get how easy it would be to eliminate humans and take over the planet. Machine understanding, however, is more of a mechanical understanding than an existential one. An AI application may pass a Turing test, demonstrating its ability to behave in a convincingly human manner, but it will still lack other human traits, like appreciation of art or humor. While a standards-based data exchange like the National Information Exchange Model (NIEM), which DOD nominally adopted in 2013, offers a framework for linking data elements across functional domains, it does not provide the structure necessary for a computer to move beyond representation of data and information to modeling knowledge or understanding. For that, we will need to adopt an ontology.

An ontology is a semantic model of data—that is, meaning is an emergent feature of how the data are related. In other words, it is a framework for applying shared meaning to data that humans and computers can understand. The building blocks of this model are “triples,” each containing a subject, a predicate and an object, which are understandable by both humans and computers. The subject and object are data elements, and the predicate describes the relationship between them. These relationships

can express a taxonomy, outlining that a brigade contains battalions and a battalion contains companies; they can also define that a brigade is led by a colonel, or a squad contains between four and 10 Soldiers. This structure can be expanded to describe equipment and supplies, the capability of weapons, characteristics of maneuver and more.

Identifying the potential effect of isolated weapons on a particular target is a cumbersome task akin to delivering a series of rocks—“Is this it?” Each weapon-target pairing is applied in series to determine the outcome. While this approach could be aided with tabulated look-up tables, deductive reasoning can provide solutions, often involving multiple weapons or tactics, such as timing weapons in a series, to deliver a desired effect on a specified target. With a structure in place to provide the logic, an algorithm can determine which units have weapons with the desired effect on a selected target, as well as their ability to maneuver as necessary, given the speed of their vehicles and the state of their supplies.

#### IS IT DEDUCTIBLE?

Deductive reasoning is being applied to analysis of suspected chemical or biological laboratories. One could approach this problem by making an exhaustive list of materials and equipment used in the production of various substances and then comparing those lists to what is found in a given facility, but it’s difficult to be comprehensive.

A gas burner and a beaker might be the laboratory standard for heating a liquid, but if we look for those specific elements, we might miss the more common case of a heat source like a fire and a container capable of holding hot liquids, like a metal pot. An ontology might specify that a pot has the capability of holding liquid and is

composed of steel, while steel has the property of a high melting point, which allows heat to be applied to raise the temperature of a liquid contained in the pot.

This might seem intuitive to a human based on learned experience, but it is a fairly complex concept for a computer, though one apparently not lost to Arnold Schwarzenegger’s Model 101 terminator at the end of the second movie when he lowers himself into a vat of molten metal.

#### CONCLUSION

AI has long been a staple of science fiction, allowing mechanical beings to interact with humans on more or less equal terms. In the dystopian tradition, technology is often presented as a menace, as in the “Terminator” series, or HAL from “2001: A Space Odyssey,” but there are also more positive AI role models in popular culture, such as C-3PO from “Star Wars” or Tony Stark’s “Iron Man” interface, Just A Rather Very Intelligent System (JARVIS). One might imagine similar technology supporting our Soldiers, warning them of incoming threats and plotting opportunities through data-informed course of action analyses.

The Army Data Strategy includes a goal for making data understandable by users, but this should be expanded from human users to AI agents as well. Providing an ontology as a structure for machine understanding is essential for future AI applications. JARVIS embodies many of the capabilities

the Army seeks to enable with AI, for example: automatic speech recognition combined with natural language processing, visual entity extraction and automatic target recognition, health monitoring and damage assessment. Absent a knowledge structure for machine reasoning, many of these capabilities cannot be realized.

Another goal of the Army Data Strategy is for data to be interoperable across systems. This is supported by data exchange standards, but adoption of NIEM and an ontology framework like Basic Formal Ontology (BFO) are not mutually exclusive. One can be used to supplement the other, and both use universal resource indicators to unambiguously identify data elements. The development of conceptual domain ontologies is necessary for reasoning to span domains such as medicine and logistics, or fires and command-and-control, where the same data element may have different types of relationships. Because ontologies are extensible, allowing data elements to have different types of relationships, domains can be developed independently to an extent, but should still be governed by an umbrella framework such as BFO, to ensure that those relationships are defined in a consistent manner.

The potential for computer reasoning to advance the Army’s ability to get supplies to hospitals at the time of need, or optimizing battle plans, represents a transformative future for our Army and our military.

## The need for a broader AI tool was highlighted by the Army National Guard’s efforts to support the national COVID-19 response.



### KILLER ROBOTS? NOT QUITE

Computer reasoning will help AI—or robots—save lives in the future. (Image by Getty Images/gremlin)

“Killer robots?” they’ll ask.

“Maybe, but also robots that save lives.”

*For more information, contact Thom Hawkins at [jeffrey.t.hawkins10.civ@mail.mil](mailto:jeffrey.t.hawkins10.civ@mail.mil) or visit the website of Basic Formal Ontology, at <https://basic-formal-ontology.org>; NIEM, at [niem.github.io](https://niem.github.io); or the Project Manager (PM) for Mission Command, at <https://peoc3t.army.mil/mcl>.*

---

*THOM HAWKINS is a project officer with PM Mission Command, assigned to the Program Executive Office for Command, Control and Communications – Tactical, Aberdeen Proving Ground, Maryland. He holds an M.S. in library and information science from Drexel University and a B.A. in English from Washington College. He is Level III certified in program management and Level II certified in*

*financial management, and is a member of the Army Acquisition Corps. He is an Army-certified Lean Six Sigma master black belt and holds Project Management Professional and Risk Management Professional credentials from the Project Management Institute.*

*KEN LORENTZEN is the chief engineer and technical management division chief for PM Mission Command. He holds an M.S. in software engineering from Monmouth University, an M.A. in management and leadership from Webster University and a B.S. in engineering science (communication systems) from the City University of New York – College of Staten Island. He is a member of the Army Acquisition Corps and certified Level III in both engineering and program management, and is a graduate of the Defense Acquisition University Senior Service College Fellowship (2013). He is a veteran of the U.S. Navy and a graduate of Naval Nuclear Power School.*



# BEEN THERE, DONE THAT AI NEEDS DATA

AI may enable government PMs to get ahead of acquisition problems for the first time.

*by Dr. Charles K. Pickar*

**O**ur world creates, collects and is driven by data. Google, Facebook, your insurance company and even your local grocery store collect data and use it to better their chances for success. When done correctly, that advantage leads to increased profits. We need to do the same thing: create and collect our acquisition data and explore how we can apply it through artificial intelligence (AI) for acquisition success.

Why artificial intelligence? Because we need help in the complex world of systems acquisition and because we lack the right tools to bring in developments on time and on budget. We are always behind. The tools and processes developed in the 20th century analog world are just not effective in the digital world of the 21st century. We need a new tool to bring keep programs on time and on budget. Artificial intelligence, backed by big acquisition data, is that new tool. We must start thinking about how AI can help program managers (PMs) today. And that starts with the acquisition experts defining what we want AI to do.

## **A JOB DESCRIPTION FOR AI**

Today, weapon-systems development is a people-intensive, hands-on activity requiring paperwork, bureaucratic processes and communication. In this age of COVID-19, a work-quarantined PM friend recently told me that he is finally getting used to not having paper in his hands to read and make decisions. He quite proudly told me, “I am finally getting used to looking at the reports on a screen rather than having them put in my inbox every day.” While he is a bit of a dinosaur, the fact is many of us are not wholly on board with everything digital. We need to get that way.

The second thing he said struck me as well. “I never realized the drudge work of project management.” He was used to moving around and traveling, and staying at home forced him to focus on the not-so-fun parts of his job. It’s too bad it took him this long, but most of us already know



### A ‘BIG’ DEAL

Data scientists across DOD are working to employ machine learning and artificial intelligence, both of which rely on large amounts of data, commonly referred to as “big data.” By identifying and examining patterns across large data sets, the Army Acquisition Workforce might better understand its work processes and predict future outcomes. (Image by Getty Images)

acquisition isn’t all drama and excitement. It has tasks that require the human touch, but the fact is, project management can be rudimentary, repetitious and in many cases, just boring. We need to get smart and let machines do the boring work.

Stephen Wolfram, a prominent scientist and software executive and CEO of Wolfram Research, describes the challenge of AI. It’s not the ability to perform high-level tasks—because it can. Instead, he says, the challenging issue is humans being able to describe in detail exactly what we

want AI to do, because AI out-of-the-box has no value. In order to describe exactly what we want AI to do, we need to take a look at what we do in acquisition. From there, we can decide.

What is it that AI should do? We get there by asking what it is that the PM and staff do. People in DOD, warfighter and PM alike, know what needs to be done, and what they alone must do that cannot be delegated to a computer. Once we have figured out that division of labor, we can think about what goes into AI.

PMs solve problems and coordinate program activities. They also plan for what’s next and war-game strategies to address upcoming events, whether milestone reviews or testing. Lastly, PMs must spend time communicating with their people formally through reviews and counseling.

While these are broad areas, each offers opportunities to shift effort to those things that allow a PM to influence the activities, rather than being a “rider on the bus.” For example, planning an

acquisition program is a major effort. We start with a blank whiteboard and spend significant time developing a plan. We can identify previous, similar programs, whether aircraft or tank, and use AI to provide a plan outline and milestones. Further, if we have collected the data, we can examine planning assumptions and their actual outcomes against our proposed plan. Finally, AI can compare our cost and schedule estimates against historical actuals.

Another example, risk management, is a major part of control. While every program is different, the causes, likelihood and consequences of risk have some degree of similarity. AI, with the appropriate historical data and training, can help a PM anticipate risk occurrences and often provide the time needed to prevent a risk from turning into a showstopper. Automating risk warnings are a way to reconfigure the PM's time.

We must examine all of our processes, from contracting to systems engineering, from planning to program control, to decide where AI can best help us do our jobs better.

**We must get serious about the data we need, related to what we want AI to do.**



### DECISION TIME

AI is just about everywhere. Search engines, social media, smartphone digital assistants and even local grocery stores are already using AI to improve their offerings. To make meaningful use of this technology, the Army should first decide and describe in detail which problems it wants AI to solve. (Image by Getty Images)

Think of AI as an expert consultant that you hire to come into your program. Consultants bring knowledge and an outside perspective informed by their understanding of best practices across an industry. They track the lessons learned. They are experts focused on the details necessary for success. They can bring their data and lessons learned into your program. That captures the essence of what AI can do. Decide what you want and define the consultant-like capability that can reside within your program,

available 24/7 to inform and, if necessary, provide you advice.

### CARE AND FEEDING OF AI

We have data. Lots of it. We have to ask why we collect what we do. Much of the data we gather today is a result of legal and regulatory requirements. We have to define how it should be formatted. Machines can only work with specific formats. And the data has to be organized, accurate (no mistakes or typos), complete (no missing fields) and, most importantly,

in a format that can be translated into AI through machine learning.

We also must get serious about the data we need, related to what we want AI to do. We are great in cost data because that is easy to understand and measure, and we have taken the time to develop meaningful tools.

We need to get better in schedule and performance data by explaining better what causes deviations from the plan, and what we can do to get back on the plan. For instance, there are a finite number of reasons a schedule changes. Capturing those reasons for use in AI can be a

powerful planning tool to allow future PMs insight into potential schedule problems. Finally, we need to capture our thinking in both planning and execution. In planning, we should be articulating our assumptions and, while executing, describing whether those assumptions were valid or not and, more importantly, why.

### THE PATH TO AI

We get to AI through machine learning. The data provides historical information and lessons learned. Machine learning is an iterative and cyclical process that depends on user and system feedback. Users must provide comments on the fielded system capabilities and problems

to allow constant improvement through regular updates, which will also incorporate newly generated data.

AI identifies patterns in the data to match those to something occurring in a program's execution today. It does this through machine learning, the enabling process of making data into AI. Machine learning allows computers to act or provide information without direction from an operator. One of the ways it does this is through sorting large amounts of data, referred to as "big data," to identify those patterns.

Warfighters use this pattern recognition capability to identify changes in enemy activities—changes that only appear on examination of large amounts of data over long periods of time. Physicians use pattern recognition to assist in identifying cancer in X-rays. In acquisition management, we are looking for patterns of current activity that match something that has happened elsewhere, on another program, at a different time.

Pattern matching isn't the only capability we can expect from AI, though. Statistics are also key to machine learning and AI. Statistics offer the possibility of prediction, whether using simple regression techniques to more sophisticated mathematical modeling. Prediction helps in planning and estimation, as well as risk tracking and mitigation. Prediction also provides a longer-range perspective (with the right data) by constantly comparing the present status using all available data with that of past, similar developments.

System development is a human activity that requires humans to do things in a particular way. We must examine critically whether the processes, both those based on best practices and those based on bureaucratic requirements, contribute to



### DATA COLLECTION

Army AI Task Force members held a data collection event Jan. 14 with the Aided Threat Recognition from Mobile Cooperative and Autonomous Sensors system at Fort Hunter Liggett, California. The data will be used to train the system. (Photo by Patrick Ferraris, Army Artificial Intelligence Task Force)



### MODERNIZATION THROUGH AI

Members of the Carnegie Mellon University National Robotics Engineering Center set up equipment during a data collection event Jan. 13 at Fort Hunter Liggett. A partnership between Carnegie Mellon and the Army's AI Task Force aims to modernize the Army and its processes through AI. (Photo by Patrick Ferraris, Army Artificial Intelligence Task Force)

the mission and make sense. More importantly, we must be sure they are efficient. AI can and will do what we teach it, but it can't think and it can't tell if something makes sense.

### CONNECTING THE DOTS

There is good news in the potential for AI to address the complexities of weapon system development, but AI can't fix everything. AI offers the possibility of radically changing the PM's role from reactive to proactive. The biggest challenge for PMs is to clearly define their expectations for AI

so the system will contribute to program success.

The biggest challenge for DOD is the data—determining whether it's the right data, in the right quantities and if it is clean and accurate. To perform at an optimal level, AI requires big data, and the data must be relevant to the way we do business.

Data collected “because we've always done it that way” wastes valuable effort that could be better focused on getting exactly

what we need. That requires a focus on the data collection and reporting that we don't have today.

As a NATO-ally friend of mine once told me, “You Americans are world class at collecting lessons learned. However, I don't see you really learning any lessons from the data that you collect.”

Artificial intelligence offers the possibility of using the history captured in acquisition data, the lessons learned, to enable PMs to address the complexity of weapon system development head-on and learn from our lessons. AI can't replace PMs, but its potential offers the chance for the defense acquisition community to get ahead of the relentless complexity of system development and be able to get cost, schedule and performance right. And it can permit us to get ahead of the problems for once.

---

*DR. CHARLES K. PICKAR is a senior lecturer at the Naval Postgraduate School (NPS) in Monterey, California, where he teaches program management, acquisition and systems engineering in the Graduate School of Defense Management. He has more than 30 years of management and research experience, including leadership positions at the Johns Hopkins University Applied Physics Laboratory, Science Applications International Corp., and Lockheed Martin Corp. He holds a doctorate in business administration from Nova Southeastern University, an M.S. in systems engineering from Johns Hopkins University, an M.A. in national security affairs from NPS and a B.A. in business from the University of Maryland. He is a graduate of the U.S. Army School of Advanced Military Studies. The author's last *Been There, Done That* column was “An Exercise to Experience,” in the Fall 2019 issue.*

# LEARNING IN THE FACE OF PANDEMIC



For the Army Acquisition Workforce, training has continued in spite of the limitations brought on by COVID-19.

**T**he COVID-19 pandemic has greatly impacted the world and every aspect of our lives. This is true as well for the Army Acquisition Workforce (AAW), emptying workplaces as we learn to do our jobs from our homes.

In our spare time, we've binge-watched shows (my wife and I are fond of "Dead to Me" and "Schitt's Creek"), adopted pets, started new exercise programs, ate far more home-baked bread, cooked many more homemade meals and worked in our gardens. Some parents have learned how to keep their kids engaged in school, prepare meals and work full-time jobs simultaneously. Needless to say, things have been very different these last several months.

So what does the future hold for the AAW? As we receive guidance from leadership and gather data on how our affected operations are working, we have to envision and plan for what will follow. I suspect that our "new normal" will be somewhere in between what we used to consider normal—full offices with maybe a day of teleworking—and our current reality—virtually empty offices and full-time



### ONLINE GRADUATION

On May 19, the DACM Office-sponsored DAU Senior Service College Fellowship held a virtual graduation for 26 students who completed the 10-month program. (Photos courtesy of DAU – SSCF)

teleworking. I think we'll have to find the right balance of a reduced footprint with greater telework when and where appropriate, keeping the health of the individuals in our workforce at the forefront of all considerations.

I'm concerned that the suspension of so many development activities will have a negative impact on the workforce. But one of the many areas in which we could not falter in the face of recent COVID-19 events is the competence and associated training we need to do our jobs. The Defense Acquisition Workforce Improvement Act was enacted in 1990 to professionalize and establish education and training standards for the defense acquisition workforce—not even a pandemic could stop that.

### CENTER OF EXCELLENCE

The Army Acquisition Center of Excellence (AACOE) has conducted three virtual classes utilizing the Defense Collaboration Service (DCS). Twenty-three students completed the nine-week Army Acquisition Professionals Course; 20 students completed the one-week Army Engineering and Test and Evaluation Course; and 21 students completed the four-week Army Intermediate Contracting Course. AACOE has now changed its virtual platform from DCS to Microsoft Teams, which doesn't require a CAC, and started an Army Acquisition Professionals Course with 36 students in mid-May.

How was the AACOE able to accomplish this on short notice? In early March, Director Kevin Zurmuehlen and his team began to develop contingencies in the event classes couldn't be held in

person. They decided to use DCS, since it was already up and running. Some changes were made to the curriculum, limiting group collaboration and revising some group work into individual work. To ensure that the virtual classes went smoothly, a monitor was designated for each class. The monitor was responsible for troubleshooting technical issues and assisting the instructors and students if issues arose. This allowed the instructors to focus on teaching and the students on learning. In short, the entire AACOE staff came together to adjust the curriculum, learn the platform in minimal time and provide the instruction in a new and creative way.

### DAU

The Defense Acquisition University (DAU) has had to scramble to convert its traditional in-person classes into virtual ones, and

**But our ability to quickly respond and maneuver has made it possible for the AAW to continue the important and required training it needs.**



**HUNTSVILLE CLASS**

Class of 2020 graduates of the Huntsville, Alabama, DAU Senior Service College Fellowship.

**Detroit Arsenal Seminar Class of 2020**



Phillip Burton



Erik Kallio



Jason Middleton



Elizabeth Miller



Kenny Wong

**DETROIT CLASS**

Graduates of the Detroit Arsenal, Michigan, DAU Senior Service College Fellowship, Class of 2020.

that process continues daily. From mid-March to the end of May, 463 classes had been on the DAU schedule; 373 of them were successfully converted to virtual instructor-led training (VILT). That’s an incredible rescue rate of over 80 percent. Nearly 12,000 students had originally planned to take those classes; 9,301 took the VILT offering. That’s in the midst of a pandemic that forced DAU to change the way it does business virtually overnight.

The DAU schedule for fiscal year 2021 has not been released, but the first quarter is expected to be all VILT. Such class sizes are a bit smaller than live training. Having too many students in an online class degrades the quality of instruction each student receives. Student priority and reservations will continue to be determined by the Army Director for Acquisition Career Management (DACM) Office.

**NPS**

At the Naval Postgraduate School (NPS) in Monterey, California, there are typically 1,700 to 2,000 students in residence at any time during the year—mostly active-duty military—with just as many students learning by distance, typically civilians. NPS turned some 300 in-residence classes into distance learning classes, to go along with the 117 classes that were already taught by distance learning.

**TWI**

The Training With Industry (TWI) program conducted a virtual orientation on May 7 for the incoming fiscal year 2020 cohort and our industry partners. The DACM Office provided all the necessary information via a digital meeting platform and followed up with a supplementary information packet. All current TWI fellows are either teleworking or at their workplaces, depending on their company’s policies. We are planning on moving forward with TWI as soon as the



## Senior Service College Fellowship Aberdeen Proving Ground Class of 2020



MICHAEL J. ACRICHE    WALTER FLOOD III    SCOTT A. NEWMAN    GARY OWEN



ROBERT N. PERRY



BRENT A. SMITH

### APG CLASS

Graduates of the Aberdeen Proving Ground, Maryland, DAU Senior Service College Fellowship, Class of 2020. Though the graduates were unable to meet for the traditional in-person ceremony, their achievements were recognized by senior leaders.

**As we receive guidance from leadership and gather data on how our affected operations are working, we have to envision and plan for what will follow.**

fellows can safely get to their new duty stations.

On May 19, the DACM Office-sponsored DAU Senior Service College Fellowship held a virtual graduation for 26 students who completed the 10-month program. The celebration combined cohorts from Aberdeen Proving Ground, Maryland; Warren, Michigan; Huntsville, Alabama; and Picatinny Arsenal, New Jersey. The cohort heard a recorded message from Dr. Bruce D. Jette, the Army acquisition executive and assistant secretary of the Army for acquisition, logistics and technology,

## SSCF Picatinny



Joseph Brescia    Eugene Conner    Jeffrey Frye  
Reinaldo Martinez    LTC Jose Maldonado    Don Palathinkal  
Matthew Zimmerman

### PICATINNY CLASS

Senior Service College Fellowship graduates from the 2020 class at Picatinny Arsenal, New Jersey. The fellows heard a recorded message from Dr. Bruce D. Jette and were congratulated by senior acquisition leaders during their virtual graduation ceremony.

and were congratulated virtually by senior acquisition leaders. It's not the same as the live ceremony usually conducted, but it was important to recognize the graduates' significant achievement.

The coronavirus pandemic is not something that we planned for. But our ability to quickly respond and maneuver has made it possible for the AAW to continue the important and required training it needs. It may not be the world we want, but for now it's the world we live in. We'll make the best of it now and at every new turn we encounter.





## BRANDON M. WILLIAMS

### COMMAND/ORGANIZATION:

Project Manager for Short and Intermediate Effectors for Layered Defense, Program Executive Office for Missiles and Space

**TITLE:** Lead systems engineer

**YEARS OF SERVICE IN WORKFORCE:** 14

### DAWIA CERTIFICATIONS:

Level III in program management, engineering, and test and evaluation

**EDUCATION:** M.S. in program management, Naval Postgraduate School; B.S. in mechanical engineering, University of Alabama

**AWARDS:** Numerous Army awards for contributions to technical design reviews, as well as engineering demonstrations and test events. Secretary of the Army Award for Excellence in Contracting Product Team of the Year Award.

## A TRIFECTA FOR CAREER SUCCESS

“Simply put, successful careers are about three things,” said Brandon Williams, lead systems engineer for the Sentinel A-4 radar program within the Program Executive Office for Missiles and Space. “Relationships, leadership and capabilities. Relationship is an enabler, leadership is the difference-maker, and capabilities represent the products of one’s career. It is impossible to know all answers to all things, but if you know the right people, you can always find the answer.”

The Sentinel A-4 is a high-performance modification of the Sentinel A-3 air and missile defense radar that will provide improved capability against current and emerging aerial threats, including cruise missiles and unmanned aerial systems, as well as rotary-wing and fixed-wing threats. The new radar will improve surveillance, detection and classification capabilities to protect Army maneuver formations and high-value static assets, including command-and-control nodes, tactical assembly areas and geopolitical centers.

Williams leads a team of engineers from several disciplines and is responsible for technical and programmatic interactions with the materiel development contractor. It’s a job that requires someone “who is able to respect the details and see the big picture,” Williams said. “You also need to be a good communicator. As lead systems engineer, I get a lot of input from the technical subject matter experts on my team. I need to be able to blend direction from a variety of sources and make the best decisions that help move the program in the right direction. Fortunately, I’ve had some great mentors, and we have some excellent senior leaders in our organization to serve as an example of how that’s done.”

To further strengthen his leadership skills, Williams completed the IDEAL—Inspiring and Developing Excellence in Acquisition Leaders—program in October 2019. “I would recommend it to anyone who wants to better understand themselves and learn how to positively influence others around them,” he said. “As a result of what I learned, I feel I can more effectively lead a group of people with diverse backgrounds. And the sessions on crucial conversations outlined how to have hard conversations without breaking down relationships.”

Williams also sees the value of offering IDEAL to junior members of the acquisition workforce. “I think it’s a great class from the mindset of ‘I’m a leader. How do I get the best out of my team?’ But I think GS-7s through GS-9s would benefit from the perspective of ‘How can I best support my leadership and begin to learn the characteristics to one day be in a leadership role myself,’” he said. “People in the earlier stages of their careers are not aware of challenges that leadership faces. And, often, as a junior employee, you’re given a task but you don’t really know why you’re doing something or how it fits in a bigger picture. Communication and relationship-building are easier and more beneficial to both sides if everyone knows what the goal is.”



### STANDING SENTINEL

Williams says his job with the Sentinel A-4 radar program requires that he “respect the details and see the big picture.” (Photo by PEO Missiles and Space)

Williams joined the Army Acquisition Workforce in 2006 after graduating from the University of Alabama. His first assignment was with the Close Combat Weapon Systems project office as a systems engineer for the TOW—tube-launched, optically tracked, wire-guided—missile. “I hired in under a two-year development plan as a general engineer. At first I was just happy to have a job, but I soon realized how lucky I was: Acquisition provides a unique opportunity to serve my country outside of the traditional military setting. I didn’t know then that I’d still be here 14 years later, but it has been great—and I’ll gladly stay another 14 years if they’ll let me.”

In 2014, he was assigned to the Cruise Missile Defense Systems (CMDS) project office, which he noted was an important transition point in his career. His first assignment at CMDS was the Indirect Fires Protection Capability Increment 2 – Intercept (IFPC Inc 2-I). “Before joining CMDS, my experiences were mostly related to contracts for operations and sustainment and obsolescences. IFPC Inc 2-I afforded me the opportunity to join a program at milestone A,” he explained. “Accordingly, I was able to go through and benefit tremendously from events such as system requirement review, system functional review, preliminary design review, critical design review, technical readiness

review and Army Systems Acquisition Review Council walkups, as well as capability development document approvals and several demonstration and test events.” His work with CMDS also provided the opportunity to serve as co-chair on a source selection evaluation board, where he helped develop the request for proposals package; led the factor and subfactor teams in evaluating technical, cost, small business and past performance specifications; and ensured that all systems performance specifications were adequately addressed.

For Williams, the biggest takeaway was the breadth and depth of the defense acquisition enterprise. “As a whole, it’s larger and more complex than most people realize,” he said, “and no one is an expert in all of it. But it has so many niches and nuances, and there are plenty of ways you can make yourself an expert in one area if there’s something that really appeals to you.”

Looking back over the past 14 years, he identified a couple of notable changes. “With the Army modernization effort, we’re seeing a shift from system-based project offices to product-based offices. It’s a great idea, but it’s a big change, and it will take some time to adjust to it,” he said. “I’ve also noticed that there’s a growing need for each person to be multi-disciplined—a leader can’t just wear one hat anymore. He or she needs to have a solid background in technical issues, communications and program specifics.” Williams also noted the increased importance of building relationships within and outside of his organization. “It’s vital that you’re able to network with others, both to support the program you’re working on and to help resolve issues that come up. If you’re having a problem, chances are someone else has had it, too, and their experiences can help you figure out a solution.”

—SUSAN L. FOLLETT

# AN EDUCATION IN DISTANCE LEARNING

The challenges of virtual education are many but can be overcome by putting the focus on the student.

*by Jacqueline M. Hames*

It's only 10 a.m. and your house is a zoo—the first grader has to commandeer your computer to print an assignment, the sixth grader is attempting a presentation on Zoom and your spouse is on a conference call with the one person in the whole of the organization who never puts himself on mute.

Forget bandwidth issues, you need a referee.

These are the types of challenges many people face while working and educating at home—whether you're educating yourself or members of your family. The situation varies in each household, of course, but everyone has faced challenges during the COVID-19 pandemic, be they interpersonal, educational or technological. So, what happens when you're trying to further your career through training and education and you hit a stumbling block in virtual learning?

You focus on the student.

## **THE SHIFT**

“The sudden onset of the COVID-19 pandemic in the United States immediately impacted the way most of us live our lives and conduct business,” said Susan Clark, Defense Acquisition University (DAU) team lead and acquisition training development manager with the

Office of the Army Director for Acquisition Career Management (DACM). “The national mitigation strategy called on all entities within the United States to practice social distancing and look at other ways to deliver goods and services. Schools and colleges were closed, and students, teachers and parents had to quickly learn how to study and teach virtually. The Defense Acquisition University is no exception.”

Thousands of students who were enrolled in resident classes at the time social distancing restrictions were put in place had to reschedule travel plans and return to their permanent duty stations immediately. Other students were temporarily stranded—but once DAU addressed the needs of students currently in training, they could focus efforts on future classes, Clark explained.

“DAU has reviewed their class schedule one week at a time to determine which classes could be delivered virtually and which classes would need to be canceled,” she said. “Transition from resident [classroom] training to virtual instructor-led training [VILT] has been well received, but the VILT offering has not been without challenges.”

Some students prefer hands-on, in-classroom training because it helps them learn better. Others find they have too many distractions in the home, from children needing help with schoolwork to spouses also working from home, Clark added. Then there are the technological challenges, like low bandwidth or issues using WebEx, which is DAU’s virtual learning platform. Finally, there may be scheduling conflicts—resident classes may have been rescheduled virtually at new times and previously enrolled students may not be able to attend anymore. Despite the challenges, Clark said the lessons learned during the pandemic have been beneficial.



### KEEPING A DISTANCE

Spc. Tyler Reninger, with the 301st Maneuver Enhancement Brigade, reviews course materials with his instructors and classmates during the emergency Basic Leader Course in Jordan. Because of the COVID-19 pandemic, junior enlisted Soldiers are continuing their professional military education through distance learning while travel restrictions are in place. (Photo by Capt. Ernest Wang, Area Support Group – Jordan)

“These new challenges provide DAU instructors with experience and knowledge to create new, pandemic-response case studies which have been integrated into DAU course content,” Clark said. “VILT requires no travel and, as a result, the government has saved hundreds of thousands of temporary duty travel dollars.”

Most importantly, DAU’s virtual classes gave students the means to meet their certification requirements as planned, she said.

### FUTURE VIRTUAL EDUCATION

The COVID-19 pandemic has given the Army the opportunity to reassess how it trains its workforce, but the unique challenges of distance learning still need to

be addressed. As Clark mentioned, some students prefer the resident experience because it provides more focus and interaction. And Soldiers will always need resident military education and training of some kind because their experience isn’t purely academic.

However, the future of Army education could shift to a more virtual experience—so how do we do that?

With student-centered learning, said John Dillard, senior lecturer for systems engineering at the Naval Postgraduate School’s (NPS) Graduate School of Engineering and Applied Sciences.

Dillard has been teaching at NPS since 1994 and has run the DAU equivalency



### A NEW TWIST ON TRAINING

Sgt. Maj. of the Army Michael A. Grinston oversees 3rd Infantry Division Soldiers training with safety measures in place, such as the use of face coverings and physical distancing, at Fort Stewart, Georgia, in May. (Photo by Defense Media Activity – Army)

program at NPS for about 22 years. NPS was already well prepared for the shift to 100 percent distance learning when the pandemic hit, as they had been practicing that mode of education for a long time. “We’ve been conducting distance learning for over 20 years,” Dillard said. “We started out with VTC [video teleconferencing]—you needed a phone line and had to herd all the students into a conference room. It suffered from low bandwidth and frequent disconnections, but we still had confidence that live, synchronous, distributed education could work if we

could maintain vigorous dialogue as a component.”

The distance learning courses at NPS have always been faculty-led and calendar-paced courses, which allows for more live interaction with the students and keeps them on track, Dillard said. Nowadays, using applications like Zoom and Microsoft Teams, Dillard and his colleagues can execute synchronous education—teaching in real time—as well as using asynchronous courses, “flipping the classroom” with recorded lectures and independent

readings. But Dillard has recognized the same challenges at NPS that DAU is experiencing with distance learning—distraction, obstacles to engaging with the material and technology issues. He believes the student-centered learning approach will help mitigate those issues.

Student-centered learning puts the onus on the students, Dillard explained. They must take the content that is hand-picked for them by professors, consume and analyze it, and then connect that material with other readings, and synthesize

answers to the “so what” questions. Professors have to think a little outside of the box for this to work, posing questions in a “cagier way to elicit critical thinking,” he said. Dillard also recommends professors construct class sessions to be as organized as possible, providing specific due dates to keep students on track with their lessons and projects, and using the available technology in innovative ways to keep students engaged.

“This idea of student-centered learning, I think, is really powerful,” he said. There will likely be some multitasking (like checking text messages and email) occurring in a distance learning environment, just as in a resident environment, and there can always be other distractions, Dillard added. That’s why educators must require periodic deliverables. “Written essays, well-constructed exams and oral presentations seem to be a good means of ensuring engagement,” he said.

## CONCLUSION

Civilian learners aren’t the only ones who’ve had to make the transition to the virtual classroom. Both the U.S. Military Academy at West Point and the U.S. Army War College have gone online, Sgt. Maj. of the Army Michael A. Grinston said during an April virtual town hall at the Pentagon. The U.S. Army Sergeants Major Academy has also moved to virtual schooling using Blackboard, he said.

“We have actually suspended the select, train and promote policy for SLC and ALC, the advanced leaders course and the senior leaders course, so those sergeants that are eligible and in good standing with all the qualifications and meet the cutoff score, they will be promoted to staff sergeant, and those staff sergeants that are eligible and need to be promoted, they will get promoted to sergeant first class,” Grinston said. Soldiers have two ways to



## VIRTUAL LEARNING

Student-centered learning will help mitigate the challenges people have with distance learning. (Image by U.S. Army Acquisition Support Center)

make up the professional military education requirement—apply for an exception, or go back and do the school later, he explained.

Recruiting, promotion boards and reenlistments continue virtually, as well. “We’re just finding great and creative ways to do this. I agree with the chief [of staff of the Army]. This is going to show what we can do in the future if we have to,” Grinston said.

“I have no doubt we’ll want to go back to brick and mortar soon as we can,” Dillard said when asked about the transition back to “normal” once the crisis is over. But he thinks some paradigms will shift and distance learning opportunities will continue to expand. People will be forced to question whether they need to be physically present in the office or the classroom to accomplish things. “We like the

idea that our students don’t have to be in the same room with us to learn,” he said.

DAU is on board with continuing distance learning as well. “It’s unknown what future DAU class schedules will look like, but this pandemic has proven that some of DAU’s course content can effectively be delivered virtually. It should only be expected that VILT will be a permanent and more prominent course delivery method in future class schedules,” Clark said.

*For more information, contact the author at [jacqueline.m.hames.civ@mail.mil](mailto:jacqueline.m.hames.civ@mail.mil).*

*JACQUELINE M. HAMES is an editor with Army AL&T magazine. She holds a B.A. in creative writing from Christopher Newport University. She has more than 10 years of experience writing and editing news and feature articles for publication.*

ON THE

# MOVE



## THE WHITE HOUSE

### 1: PERNA TO CO-LEAD COVID-19 VACCINE EFFORT

**Gen. Gustave F. Perna**, commanding general of U.S. Army Materiel Command (AMC) since September 2016, has been named one of two leads for Operation Warp Speed, President Donald Trump's effort to find a vaccine for the novel coronavirus by January 2021. On May 15 in the Rose Garden of the White House, Trump announced that he had selected Perna and **Dr. Moncef Slaoui**, a former chairman at Glaxo-SmithKline Vaccines, to head the ambitious operation. Perna will serve as chief operating officer and Slaoui as chief scientist.

The goal is to produce about 300 million vaccines by January, according to **Jonathan Rath Hoffman**, assistant to the secretary of defense for public affairs.

"When a vaccine is ready, the U.S. government will deploy every plane, truck, and Soldier required to help distribute it to the American people as quickly as possible," Trump said. That's where Perna comes in, as one of the top logisticians in the U.S. military. Before being named commander

of AMC, a preeminent logistics and supply-chain operation with 190,000 military, civilian and contractor employees and a presence in all 50 states and 152 countries, Perna served as the Army's deputy chief of staff, G-4 (Logistics) and director, J-4, of United States Forces – Iraq during Operations Iraqi Freedom and New Dawn.

At the White House, Perna said, "I'm very excited about this team. ... I also feel very confident that the team will be able to provide the results as directed. It is going to be a Herculean task, but the combination of the two main partners—between [the U.S. Department of] Health and Human Services and the Department of Defense—their combined strengths, partnered with the other teammates, will ensure our success.

"One of the great advantages that we have as a military is our ability to do logistical and sustainment operations afar. We're just going to apply those capabilities to this mission. This mission is about defeating the enemy. We will defeat the enemy. Why? Because winning matters."



**DEPUTY ASSISTANT SECRETARY OF THE ARMY FOR RESEARCH AND TECHNOLOGY**

**2: NEW LEADERSHIP FOR DASA(R&T)**

**Dr. Philip Perconti** was selected as the deputy assistant secretary of the Army for research and technology (DASA(R&T)) and Army chief scientist in November 2019. Perconti is responsible for policy and oversight of the Army's research and technology programs, which span 16 laboratories and research, development and engineering centers; employ nearly 12,000 scientists and engineers; and have an annual budget that exceeds \$2.4 billion. He is charged with identifying, developing and demonstrating technology options that inform and enable effective and affordable capabilities for the Soldier.

Before this assignment, Perconti served as director of the U.S. Army Combat Capabilities Development Command (CCDC)'s Army Research Laboratory (ARL). He also previously served as director of the laboratory's Sensors & Electron Devices Directorate. In addition, he led ARL's science and technology campaign for materials research and started the Army's major research initiatives in quantum information sciences and artificial intelligence.

**3: RUSSELL RETIRES AFTER 30-YEAR CAREER**

**Dr. Thomas P. Russell**, special assistant to the assistant secretary of the Army for acquisition, logistics and technology (ASA(ALT)) and former deputy assistant secretary of the Army for research and technology (DASA(R&T)) and Army chief scientist, retired March 30 with more than 30 years of government service.

Russell served as DASA(R&T) and Army chief scientist from April 2016 until November 2019. He also previously served as director of the U.S. Army Research Laboratory; director of the Air Force Office of Scientific Research (AFOSR); director of the Aerospace and Material Sciences Directorate, AFOSR; and director of the Research, Development, Testing and Evaluation Directorate at the Naval Surface Warfare Center.

**4: NEW HEAD FOR PLATFORMS AND WEAPONS TECHNOLOGY**

**Michael Holthe** was appointed as director for Platforms and Weapons Technologies in the Office of the Undersecretary of Defense for Research and Engineering on April 12. Holthe oversees the planning, programming and budgetary decisions affecting all programs in the areas of materials, munitions, aerospace, power and energy, directed energy, and counter-unmanned aerial system technologies, and platforms across the domains of air, land, sea and space.

Before this assignment, Holthe served as the director for the lethality portfolio, in the Office of the Deputy Assistant Secretary of the Army for Research and Technology. He holds an M.S. in exercise science (biomechanics) from Iowa State University and a B.A. in sport science (sports medicine) from Saint Olaf College. He is a graduate of the Competitive Development Group/Army Acquisition Fellowship Program and a member of the Army Acquisition Corps.



**U.S. ARMY AVIATION AND MISSILE COMMAND**

**5: NEW XO FOR AMC DEPUTY CG**

**Col. Gail Atkins** relinquished command of Corpus Christi Army Depot in Texas on May 29, where she served as the depot's first female commander. She is currently serving as executive officer to the U.S. Army Materiel Command deputy commanding general, **Lt. Gen. Donnie Walker**.

Atkins' previous assignments include the Force Support Division chief for the Joint Staff, J-8, and commander of the 82nd Combat Aviation Brigade's aviation support battalion at Fort Bragg, North Carolina. Additional assignments include deployments to Afghanistan and Iraq, along with assignments in Belgium and at Fort Knox, Kentucky.



**1: NEW DEPUTY COMMANDER AT AMCOM**

**Don Nitti** was named U.S. Army Aviation and Missile Command (AMCOM) deputy commander March 14. **Maj. Gen. Todd Royar**, AMCOM commander, said Nitti was selected from among a strong list of candidates to succeed **William P. Marriott**, who retired in December 2019.

Nitti previously served as executive director of AMCOM's Logistics Center. The Lynchburg, Virginia, native has a long history with the command and worked as director of AMCOM's Field Support Directorate and Aviation Field Maintenance Directorate. He served as the AMCOM chief of staff while on active duty. Nitti also served as chief of the Sustainment Operations Division for Department of the Army Logistics (G-4).

*U.S. ARMY MEDICAL LOGISTICS COMMAND*

**2: COMMANDER TO ATTEND WAR COLLEGE**

**Lt. Col. Marc R. Welde**, commander of the U.S. Army Medical Materiel Center – Korea (USAMMC-K), will return to the United States to continue his education and professional development. Welde has been accepted and plans to attend the U.S. Naval War College in Newport, Rhode Island, where he will enroll in the college's senior course, the College of Naval Warfare, in July.

Before his two-year stint at USAMMC-K that began in June 2018, Welde served as deputy commander of operations at the U.S. Army Medical Materiel Center – Europe in Germany. His 20-year career has included leadership assignments on numerous deployments, including his selection in 2009 to serve as the senior medical operations officer for the 75th Ranger Regiment, in which he served two combat tours in support of Operation Enduring Freedom.

*U.S. ARMY MEDICAL RESEARCH AND DEVELOPMENT COMMAND*

**3: NEW CHIEF OF STAFF FOR USAMRDC**

**Col. Timothy D. Walsh** will assume duty as chief of staff for the U.S. Army Medical Research and Development Command (USAMRDC) this fall. Walsh, who plans to begin his new role in early September, has served as commander of the U.S. Army Medical Materiel Agency (USAMMA) since August 2018. During that time, he also played a vital role in the formation of the Army Medical Logistics Command (AMLC), to which USAMMA now reports.

As commander of USAMMA, Walsh led the transition team that laid the groundwork for the organization before the appointment of **Col. Michael B. Lalor** as AMLC commander. Over his 27-year military career, Walsh has served in numerous leadership positions, including as commander of the U.S. Army Medical Materiel Center – Europe before his current assignment.



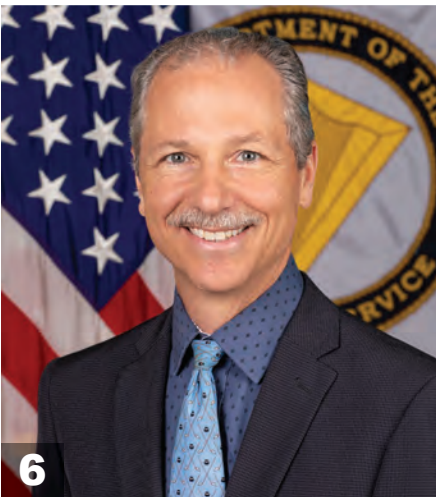

**JOINT PROGRAM EXECUTIVE OFFICE FOR ARMAMENTS AND AMMUNITION**

**4: NEW JPEO A&A TAKES THE HELM**

The Joint Program Executive Office for Armaments and Ammunition (JPEO A&A) held a virtual change of charter ceremony, at which **Brig. Gen. Vincent F. Malone II** assumed responsibility as JPEO A&A and commanding general (CG) for Picatinny Arsenal, New Jersey, from **Brig. Gen. Alfred F. Abramson III**. The ceremony was announced May 18 with a video link.

In a Picatinny tradition, Abramson passed the keys to the Cannon Gate to Malone, representing the transfer of leadership between the outgoing commander and the incoming commander.

**5: RETIRING CG HONORED WITH PARADE**

**Brig. Gen. Alfred F. Abramson III** retired from the U.S. Army after serving the nation for more than 30 years. In the culmination of his career, Abramson served as JPEO A&A and CG for Picatinny Arsenal. Because of the COVID-19 pandemic, Abramson's retirement ceremony, which had been scheduled for May 7, was canceled. Despite these unusual circumstances, Team Picatinny's employees and residents honored Abramson and his wife, Pamela, for their service with a farewell parade. (Photo by Picatinny Arsenal Photo Services)

**6: INCOMING DEPUTY FOR JPEO A&A**

**Chris Grassano** was selected to be deputy joint program executive officer (JPEO) for JPEO A&A on March 15. In this role, he provides executive leadership to efforts developing and procuring leap-ahead munitions that increase the joint warfighter's combat power. He also provides oversight for the life cycle management and sustainment of Army weapon systems and equipment, from research and development through test and evaluation, acquisition, logistics, fielding and disposition. His previous assignment was as the director for talent management and director for the Senior Service College Fellowship at Picatinny.

**PROGRAM EXECUTIVE OFFICE FOR AVIATION**

**7: PROMOTION FOR CHIEF WARRANT OFFICER**

**Chief Warrant Officer 4 Juan Amaro** has his rank insignia affixed by **Col. Rob Barrie**, deputy JPEO for Aviation, and Amaro's wife, **Rhea**, during a promotion ceremony Feb. 21 at PEO Aviation headquarters, Redstone Arsenal, Alabama. Amaro, who serves as a contingency operations officer in the PEO Aviation G-3 section, previously served as platoon leader for the 1st Battalion, 230th Aviation Regiment (Assault Helicopter) of the Tennessee Army National Guard. (Photo by Paul Stevenson, PEO Aviation)



**PROGRAM EXECUTIVE OFFICE FOR COMMAND, CONTROL AND COMMUNICATIONS – TACTICAL**

**1: NEW PM TO STAND UP**

**J. Ward Roberts** has been selected to stand up the new Project Manager for Interoperability, Integration and Services (PM I2S), which will provide a clear linkage to the cross-cutting Interoperability Network line of effort and play a key coordination role between the Army’s program offices that deliver tactical network capability and the U.S. Army Futures Command’s Network Cross-Functional Team. Roberts recently retired as a colonel after serving 26 years in the Army. His military career culminated with his position as acting executive director for the Office of the Chief Systems Engineer, Assistant Secretary of the Army for Acquisition, Logistics and Technology. He held several

critical acquisition positions while in uniform, including within the Program Executive Office for Command, Control and Communications – Tactical (PEO C3T) as product manager for the ACAT-1D Warfighter Information Network Tactical – Increment 3 and Department of the Army system coordinator.

**2: PL MISSION COMMAND CYBER WELCOMES NEW LEADER**

On April 30, **Lt. Col. Scott Shaffer** assumed the charter of the Product Lead for Mission Command Cyber from **Jerry Harper**. Shaffer joins PEO C3T from his most recent role as executive officer for the deputy assistant secretary of the Army for strategy and ac-

quisition reform. A formal ceremony has been postponed until later in the year because of COVID-19 social restrictions.

**3: VES AT PM TACTICAL RADIOS**

**Jerry Harper** has been selected as the next product manager for Helicopter and Multi Mission Radios (HAMMR), under PEO C3T’s Project Manager (PM) for Tactical Radios, effective summer 2021. In the interim, Harper will serve as the inaugural product lead for capability set development, under the PM for Interoperability, Integration and Services, as he bridges his year between standing up the product lead for Mission Command Cyber and serving as the product manager for HAMMR.



**PROGRAM EXECUTIVE OFFICE FOR ENTERPRISE INFORMATION SYSTEMS**

**4: CHANGE OF CHARTER FOR PEO EIS**

**Ross R. Guckert** assumed the charter of the Program Executive Office for Enterprise Information Systems (PEO EIS) from **Chérie A. Smith** May 21 during a ceremony at Fort Belvoir, Virginia, hosted by **Dr. Bruce D. Jette**, assistant secretary of the Army for acquisition, logistics and technology (ASA(ALT)) and Army acquisition executive.

As the new program executive officer for EIS, Guckert—who previously served as deputy PEO for Soldier—will be responsible for managing more than 37 program offices and 71 acquisition programs that support and field Army and DOD communications, logistics, medical, finance, personnel, training and procurement systems for all 10 combatant commands, with a budget of approximately \$4.3 billion each year.

**5: RETIREMENT CAPS 42-YEAR CAREER**

**Chérie A. Smith**, program executive officer for PEO EIS since April 2018, retired May 21 at a ceremony at Fort Belvoir officiated by **Lt. Gen. Paul A. Ostrowski**, ASA(ALT) principal military deputy and director of the Army Acquisition Corps.

Smith's Army career spanned 42 years and encompassed all levels of information technology management and development. Before her formal appointment as PEO, she served as acting PEO and deputy PEO. Before joining PEO EIS, she managed more than 1,200 military, civilian and contractor staff spanning 40 countries as the deputy PEO for simulation, training and instrumentation. Previously, she served as assistant deputy for acquisition and systems management. Smith began her career serving as an enlisted Soldier in the U.S. Army Reserve and later served on active-duty status in the U.S. Army.



**6: NEW ASSISTANT PEO, BUSINESS MISSION AREA**

**Col. Robert Mikesh** assumed the position of assistant program executive officer for Business Mission Area on March 6, taking over from **Col. Wayne Barker**, who departed PEO EIS to become ASA(ALT) chief of staff. Mikesh also serves as the project manager for the Army Enterprise Systems Integration Program (AESIP). (Photo by PEO EIS)



**7: ASSUMPTION OF CHARTER AT LMP**

**Gabriel T. Saliba** assumed responsibility as the Logistics Modernization Program (LMP) product director May 14 at a virtual assumption of charter ceremony hosted by **Col. Robert Mikesh**, project manager for AESIP. Previously Saliba served as the acting LMP product manager. (Photo by PEO EIS)



### ARMY OFFICER ASSIGNMENTS

Army Chief of Staff Gen. James C. McConville announced the following officer assignments:

**Brig. Gen. Robert M. Collins**, program executive officer for Intelligence, Electronic Warfare and Sensors, Aberdeen Proving Ground, Maryland, to program executive officer for Command, Control and Communications – Tactical, Aberdeen Proving Ground.

**Brig. Gen. Michael E. Sloane**, program executive officer for Simulation, Training and Instrumentation, Orlando, Florida, to program executive officer for Intelligence, Electronic Warfare and Sensors, Aberdeen Proving Ground.

**Col.(P) Robert L. Barrie Jr.**, military deputy program executive officer for Aviation, Redstone Arsenal, Alabama, to program executive officer for Aviation, Redstone Arsenal.

**Maj. Gen. Robert L. Marion** for appointment to the rank of lieutenant general and assignment as military deputy and director, Army Acquisi-

tion Corps, Office of the Assistant Secretary of the Army for Acquisition, Logistics and Technology, Washington. He is currently serving as deputy commander, Combined Security Transition Command – Afghanistan, United States Forces – Afghanistan, Operation Freedom’s Sentinel, Afghanistan.

**Brig. Gen. Johnny K. Davis**, commanding general (CG), U.S. Army Joint Modernization Command, Futures and Concepts Center, U.S. Army Futures Command, Fort Bliss, Texas, to chief of staff, U.S. Army Futures Command, Austin, Texas.

**Brig. Gen. James J. Gallivan**, chief of staff, U.S. Army Futures Command, Austin, to CG, U.S. Army Test and Evaluation Command, Aberdeen Proving Ground.



**ARMY AL&T**  
TRAVEL BACK THROUGH TIME  
IN THE MAGAZINE ARCHIVES

Download issues from 1960 to today!  
[asc.army.mil/web/magazine/alt-magazine-archive](http://asc.army.mil/web/magazine/alt-magazine-archive)



# 'TO INCLUDE' DOESN'T

| How far back does DOD's curious locution go?

**L**et's get one thing clear, "to include" does not mean "including." In certain instances, it can sort of mean "including," and in others, it can render a sentence unintelligible. And that's where the problem is.

Since I began working at a DOD contractor in 2001, I've heard nearly all of the top ranks use it—members of Congress, Soldiers, contractors, government civilians. Everyone. But it remains as wrong now as it was nearly 20 years ago.

On the first page of the preface to the Joint Chiefs of Staff's "DOD Dictionary of Military and Associated Terms," there's a screaming example of this.

"This publication," we learn, applies to pretty much everyone and everything within the DOD realm. The weirdness starts in the next sentence. "It is the primary terminology source when preparing correspondence, *to include* policy, strategy, doctrine, and planning documents." (Emphasis added.)

For someone who cares about clarity and meaning, that sentence is very close to mystifying, even if the vast majority of people within DOD would find it entirely comprehensible.

The difference between *including* and *to include* is the difference between open and closed. That's because *to include* is an infinitive and *including* is a preposition. *Including* is also an "-ing" word, which makes it just a little bit harder, because

it could also be a gerund or present participle. It is neither; it's a preposition.

Prepositions, in general, indicate position, direction or location spatially (up, down), temporally (before, after) and more subtle location-direction stuff, like "like." Like is a preposition that demonstrates a kind of proximity, even if it's not physical. "Including" is a preposition that tells us that everything that follows it shall be included. (Include comes from the Latin for *in* and *close*, so including encloses. And what prepositions give meaning to are words that represent things. "The anvil hangs over his head." Not a lot of question there about where the anvil is.

What an infinitive does—or is supposed to do—is different, and infinitives can be a little flaky. By themselves, infinitives are rather conceptual. "To be or not to be." "To receive is a blessing. To give is divine." But for the most part, an infinitive is paired with another verb to help it out. "I planned to send you the check, but I didn't have your address."

In that sentence, the verb *is planned* and *to send* is what I intended to do. (See how *intended to do* fits together? At the same time, notice the conditional nature of *to send* and *to do*.)

To recap, *including* is a preposition and *to include* is an infinitive. And just as intelligence units and artillery units have different jobs, so do infinitives and prepositions. If you need air support, you don't call in housekeeping.

### BUT WHAT DOES IT MEAN?

Clarity and meaning are elusive values in the language of DOD, much less the two together. The reasons for this are probably numerous, including the intent to leave something open to interpretation. (Image by Getty Image/seksan Mongkhonkhamsoo)



### IT GOES BACK A WRONG TIME

When and how people in DOD started saying this is anyone’s guess. A financial management expert I interviewed a few years ago theorized that it might have come from contract language, used precisely because *to include* does not mean *including*. That weasel-wording, the expert said, can give the government an out. That makes some sense.

“The government shall provide to the contractor a variety of items, to include payment, reporting and other stuff.”

That sentence is weaselly. The phrase “provide to include” is effectively meaningless. The real question, for my purposes, was to try to find out how long this has been going on. My father worked at the Pentagon in Air Force logistics back in the Vietnam era, and I never heard him say it. (If he had, my mother would have corrected him mercilessly.)

As many readers are aware, Army AL&T magazine, under different names and in slightly different forms, has been

published by the Office of the Assistant Secretary of the Army for Acquisition, Logistics and Technology and its predecessor organizations since 1960. So, what better resource than Army AL&T’s own archives to see how long this strangeness has been going on?

### A REALLY WRONG TIME

So I went online to look in the Army AL&T archives, which contain the entire history of this publication.

However, looking through the archive might be problematic—editors should have changed it, except in quotes.

Not surprisingly, a search turned up vastly more correct uses of *to include* than incorrect. In the article, “Prevention of Deterioration Center Serves All National Defense Agencies,” by Dr. C.J. Wessel and Dr. W.M. Bejuki, the authors wrote: “The materials and equipment encompassed in the scope of the Center work may be said to include all those utilized by the Armed Forces, exclusive of foods and drugs” [sic]. (The Prevention of Deterioration Center

looked at the deterioration of military materiel.)

Say whatever else you want about that sentence, which appeared in the July 1961 issue of Army Research and Development Newsmagazine, a predecessor of Army AL&T, but it uses the infinitive correctly.

In April of that same year, another article, this one only two paragraphs long, “Army Shows Rapid Growth In Basic Research Grants,” also uses the infinitive correctly. “In less than 11 full months of operation since the basic research grants program was inaugurated by the Chief of Research and Development, it has expanded to include work in 126 universities and colleges funded at \$5,317,276,” the unnamed author wrote.

In both of those examples, the infinitive *to include* helps out the verb that precedes it by clarifying what the author wants to make known. In the first example, the verb formation is “may be said”: The “work may be said to include” all of the equipment that the armed forces use. In the



second example, the verb phrase is “has expanded.” So, the grant has “expanded to include.”

Right as rain. Total sense.

### THINGS GO AWRY

In the September-December 1971 issue of what was by then updated to Army Research and Development News Magazine, there were three instances of *to include*, two of them the incorrect DOD version. A news article called “DCRD Outlines Concepts of New Initiative Programs of R&D to Meet New Army Materiel Requirements” recorded Maj. Gen. George Sammet Jr.’s October 1971 presentation to the National Security Industrial Association Symposium. (The National Security Industrial Association has been a part of the National Defense Industry Association since 1997.) At the time, Sammet was the Army’s deputy chief of research and development. Sammet told the association about research and development support of dynamic training, saying, “The areas of individual and unit training are under intensive study. The trend in individual training techniques is one of self-paced, hands-on training, *to include* peer instruction.” (Emphasis added.)

So, this affectation goes back to at least 1971. But why is this wrong?

Remember, an infinitive generally helps out the verb that comes before it. In this case, we have “The trend ... is ... to include ...”

It reads that “the trend” (subject of the sentence) “is” (verb) “to include peer instruction.” But Sammet wasn’t talking about what the trend was supposed to include. He was talking about a much smaller part of the trend, self-paced and hands-on learning. But it isn’t written that way.

So, big deal.

### TELL IT TO THE JUDGE

You could argue that this is splitting hairs. And in that example, perhaps it is. A conversation, a squib in a magazine or a longer feature—these things have the potential for typos or other errors that don’t really amount to much. And who hasn’t said, “You know what I mean.”

The problem is when you get into contracts or policy or even law. I haven’t looked to see whether Title 10 uses *to include* when it should say *including*, but I wouldn’t be surprised—wait. I just looked it up. Title 10 of the U.S. Code uses it a lot. But that’s another story.

When law or policy uses this locution, it could be a problematic. Here’s an example from DOD policy on bridge contracts. (See “On Contracting,” Page 94.) This policy came to my attention because of that article.

A bridge action describes a non-competitive action requiring a justification to include, but not limited to, a formal justification and approval (FAR Part 6 or 13.5), limited sources justification (FAR Subpart 8.4), and exception to fair opportunity (FAR Subpart 16.5), to retain the current or similar product or service as a result of delay in the negotiation and award of a follow-on contract.



### THERE ARE RULES

But that doesn’t rule out the need for some serious critical thinking about the language that DOD uses, as exemplified by the Joint Chiefs’ dictionary—critical thinking that is long overdue. Acquisition is such a complex subject that to further complexify it with affected language is not helpful. (Image by Getty Image/Chris Ryan)

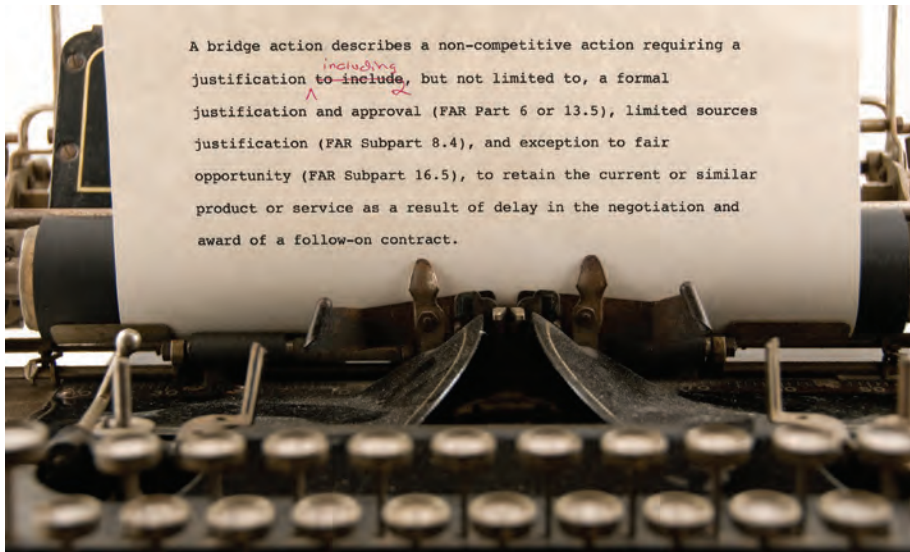

### WRITE PATH

As insistent as it is on getting the details right when discussing a weapon system or program, DOD is less careful in observing differences in meaning and using words correctly. (Image by USAASC)

Wait. What?

When I first read that sentence, it made my head spin like Linda Blair’s in “The Exorcist.”

No one would mistake policy for art. It seeks to pack in a lot and prescribes what should be done. Period. In this case, however, it also comes very close—thanks to the swap of *to include* for *including*—to being meaningless, which is one of the last things that you want policy to be.

“A bridge action describes a non-competitive action requiring a justification” is clear enough, if you happen to know anything about DOD contracting. But then it goes totally off the rails.

The common phrase is “including but not limited to,” of which only “including” has any real meaning. (Inherent in the meaning of *including* is the idea that not everything has been or would be listed.)

Where the sentence descends into meaninglessness is the swap of *to include* for *including*. Meaning disappears.

What the policy’s authors wanted to say, in no uncertain terms, is that a bridge action makes it necessary to file a whole bunch of justifying documents, including things required by statute, to ensure that the organization isn’t throwing money away. But it doesn’t say that.

Remember, the infinitive helps out a verb, clarifying what the verb is all about. In this case, we have “describes” as the verb. So “a bridge action describes to include, but not limited to, a formal justification ...”

I don’t mean to cast aspersions here except at the locution. It just makes no sense—both literally and figuratively.

### CONCLUSION

I have no illusions that anyone is going to change the way they talk. The evidence

in our archive shows that, despite editors’ best efforts, this odd affectation—for it is that, an affectation—breaks through.

Nor do I have any doubts that I will hear from readers pointing out inaccuracies here. I’m always up for learning something—especially why anyone would think this usage is justifiable.

Still, the language that DOD uses—as exemplified by the Joint Chiefs’ dictionary—could use some serious critical thinking. And it’s needed it for a long time. People say things all the time without really knowing what they mean. That’s entirely understandable because acquisition is so complex. But to further complexify it with affected language helps no one.

DOD can be really particular, even picky, about definitions. Take, for example, the recent mandate that, in DOD terminology, face mask and face covering are two different things, the former being exclusively medical grade. Just in case anyone is confused.

The utter wrongness of the *to include* usage also stands out sore-thumbishly in other ways. For an organization that cares about operational security, it might just be a bad idea to habituate people to talking in a way that nobody else does. The DOD person is easy to spot as soon as they open their mouth.

*To harass the author about any of his usage, contact [stephen.e.stark.civ@mail.mil](mailto:stephen.e.stark.civ@mail.mil).*

—STEVE STARK

---

7<sup>th</sup> Annual

# 2020 Major General Harold J. "Harry" Greene Awards for Acquisition Writing

---



**“You must have passion to do this [acquisition] business right. We need to work toward win-win solutions to our challenges.”**

*–Major General Harold J. Greene*

---

The competition is open to everyone . . . identify, discuss and influence the outcome of significant issues that affect U.S. Army acquisition through critical writing . . . tell your story to internal and external stakeholders.

Share your ideas, expertise and experiences by submitting articles, essays and opinion pieces in the following categories:

- Acquisition Reform
- Future Operations
- Innovation
- Lessons Learned



For complete competition details, go to  
[www.army.mil/asaalt](http://www.army.mil/asaalt)

DEPARTMENT OF THE ARMY  
ARMY AL&T  
9900 BELVOIR RD  
FORT BELVOIR, VA 22060-5567

ASC.ARMY.MIL

HEADQUARTERS DEPARTMENT OF THE ARMY | PB 70-20-03 | APPROVED FOR PUBLIC RELEASE: DISTRIBUTION IS UNLIMITED

“We are working with our industry partners, not only to help maintain and ensure equipment readiness for the current force, but also in fielding for the future force. I want to thank everyone in the Army’s acquisition enterprise for your hard work, your dedication to our mission and your teamwork.”

**Dr. Bruce D. Jette**  
*Army Acquisition Executive*  
Page 4

PUBLISHED BY



PIN: 206726-000