

DESIGN ■ DEVELOP ■ DELIVER ■ DOMINATE



ASC.ARMY.MIL

ARMY AL&T

FALL 2020

The Industrial Base



SMALL BUSINESS PERSPECTIVE

Innovative firms tell the good—and bad—of working with DOD

XTECH SEARCH

How industry is bringing cutting-edge tech to the Army

ON A DIME

Contractors have pivoted to keep in step with DOD through COVID-19

READ ARMY AL&T MAGAZINE ONLINE

For the current and past issues of Army AL&T magazine, go to <https://asc.army.mil/web/publications/army-alt-magazine/>.



For writers guidelines and to submit articles, go to: <http://asc.army.mil/web/publications/army-alt-submissions/>

To contact the Editorial Office:
Call 703-664-5636/5633

Email:
armyalt@mail.mil

Mailing Address:
DEPARTMENT
OF THE ARMY
ARMY AL&T
9900 BELVOIR ROAD
FORT BELVOIR, VA
22060-5567

THE HONORABLE BRUCE D. JETTE
Assistant Secretary of the Army
for Acquisition, Logistics and Technology
(ASA(ALT))/Army Acquisition Executive

EDITORIAL BOARD

LT. GEN. CHARLES D. LUCKEY
Chief, U.S. Army Reserve/Commanding General (CG),
U.S. Army Reserve Command

LT. GEN. ROBERT L. MARION
Principal Military Deputy to the ASA(ALT)/
Director, Army Acquisition Corps

LT. GEN. FLEM B. "DONNIE" WALKER JR.
Deputy CG

JEFFREY S. WHITE
Principal Deputy ASA(ALT)

ROY A. WALLACE
Assistant Deputy Chief of Staff, G-1

JAMES P. WOOLSEY III
President, Defense Acquisition University

DR. DAVID W. PITTMAN
Director of Research and Development/
Chief Scientist, U.S. Army Corps of Engineers

GREGORY L. GARCIA
Army Chief Information Officer/G-6 (Acting)

ELIZABETH WILSON
Deputy Assistant Secretary of the Army
(DASA) for Defense Exports and Cooperation,
Office of the ASA(ALT) (OASA(ALT))

JOHN J. DANIELS
DASA for Plans, Programs and Resources, OASA(ALT)

DR. PHILIP PERCONTI
DASA for Research and Technology, OASA(ALT)

REBECCA WEIRICK
DASA for Procurement, OASA(ALT))

WILLIAM H. BUCKEY
DASA for Strategy and Acquisition Reform (Acting),
OASA(ALT)

BRIG. GEN. MICHAEL J. TALLEY
CG, U.S. Army Medical Research
and Development Command

BRIG. GEN. GLENN DEAN
Deputy for Acquisition and Systems Management,
OASA(ALT)

RAY M. GAGNE
DASA for Acquisition Policy and Logistics (Acting),
OASA(ALT)

SGT. MAJ. JACINTO GARZA
Sergeant Major to the Principal Military Deputy, ASA(ALT)

CRAIG A. SPISAK
Director, U.S. Army Acquisition Support Center
(USAASC)/Director, Acquisition Career Management

NELSON MCCOUCH III
Executive Secretary,
Editorial Board, USAASC

EDITORIAL STAFF

NELSON MCCOUCH III
Editor-in-Chief

STEVE STARK
Senior Editor

MICHAEL BOLD
Editor

JACQUELINE M. HAMES
Editor

MARGARET C. "PEGGY" ROTH
Editor

ELLEN SUMMEY
Editor

MICHELLE STROTHER
ASHLEY FESSLER
Layout and Graphic Design

Army AL&T magazine (ISSN 0892-8657) is published quarterly by the ASA(ALT). Articles reflect the views of the authors and not necessarily official opinion of the Department of the Army. Articles of the Army may be reprinted if credit is given to Army AL&T magazine and the author.

Private subscriptions and rates are available from:
Superintendent of Documents, U.S. Government Printing
Office, Washington, DC 20402
202-512-1800

Periodicals official postage paid at
Fort Belvoir, VA, and additional post offices.

POSTMASTER:
Send address changes to:
DEPARTMENT OF THE ARMY
ARMY AL&T
9900 BELVOIR ROAD
FORT BELVOIR, VA 22060-5567

This medium is approved for official dissemination of material designed to keep individuals within the Army knowledgeable of current and emerging developments within their areas of expertise for the purpose of enhancing their professional development.

By Order of the Secretary of the Army:

JAMES C. McCONVILLE
General, United States Army
Chief of Staff

Official:

KATHLEEN S. MILLER
Administrative Assistant
to the Secretary of the Army
2024009

ARMY AL&T

FALL 2020

FROM THE AAE

4 A WINNING TEAM
Army, ASA(ALT) and the U.S. defense industry work together

THE INDUSTRIAL BASE

8 SMALL BUSINESS PERSPECTIVE
Army can do more to help, say innovative firms

14 MODERNIZING PARTNERSHIPS
The RCCTO's approach to rapid prototyping is evolving industry partnerships

22 THREAD LEVEL GREEN
Automation in textile production brings value to the Soldier

28 THE HYPERSONIC AND THE CAVE
The Army's depots and arsenals aren't well suited to handle new and complex weapon systems

34 NOTHING TO SNEEZE AT
What to know and avoid about brand name restrictions

40 TARGET: RISK REDUCTION
Risk model will help JMC ensure a steady supply of ammunition

45 THE VISIBLE SUPPLY CHAIN
Dashboard for Soldier-worn display allows for unified tracking of system components

50 INDUSTRIAL STRENGTH
Missile-seeker components illustrate how the Army works with industry



ON THE COVER

The Industrial Base—from the largest defense industry companies to the smallest nontraditional contractor—works in partnership with DOD to build the “arsenal of democracy.” From massive and complicated weapon systems to secure software to the uniforms and boots that our Soldiers wear to aircraft, ships and tanks, that partnership keeps our nation free and safe.

ARMY AL&T

FALL 2020

- 54** GFEBS FINDS ITS SEA LEGS
Army helps Navy transition to GFEBS
- 60** STRENGTH THROUGH COOPERATION
U.S. works to strengthen alliances, attract new partners through foreign military sales
- 64** FACES OF THE FORCE: GIOVANNI ODDO
A problem solver takes on acquisition
- 66** FREE, URGENT AND SCARCE
Army's xTechSearch program leverages its success
- 75** 10 GOOD IDEAS
XTechSearch program uncovers value and innovation
- 80** FACES OF THE FORCE: RYAN DEVINE
Engineering acquisition

FEATURE ARTICLES

- 82** DIALING UP CRITICAL CARE
NETCCN revolutionizes digital care to patients
- 87** REALIGNING FOR A REASON
PEO C3T heightens focus on unified approach to network modernization
- 93** A RISKY BUSINESS
The gambler's approach to risk
- 98** DRIVING FUEL CHOICES
Alternative energy sources for vehicles don't cut it, according to the requirement
- 106** LEADING AN AGILE WORKFORCE IN TIMES OF CRISIS
USACE employees a top pandemic priority
- 112** CCDC'S ROAD MAP TO MODERNIZING THE ARMY: ASSURED POSITIONING, NAVIGATION AND TIMING
Working to get Soldiers where they need to go
- 118** RADIO MODERNIZATION IN ANY LANGUAGE
Soldier helps establish new strategy in Afghanistan
- 122** TRAINING FOR SUCCESS
XM808 had a successful and collaborative limited user assessment
- 127** USER TESTED
USAMMDA works in theater to ensure warfighter health and safety

SUBSCRIBE

TO RECEIVE THE PRINT VERSION OF THE MAGAZINE AND E-MAIL ALERTS WHEN NEW ISSUES ARE AVAILABLE.

- 132** FACES OF THE FORCE: LT. COL. CASSANDRA N. FORRESTER
Facing challenges with confidence

CRITICAL THINKING

- 134** ON A DIME
Contractors keep step with DOD through pandemic response

COMMENTARY

- 140** BEEN THERE, DONE THAT: GETTING TO A WIN
How industry responds to your RFP
- 147** INTELLIGENT CONTRACTING
A vision of the future of federal contracting
- 154** INDUSTRY INSIGHT: COMMUNICATION SKILLS
Industry helps to keep tactical communications interoperable as Army modernizes

WORKFORCE

- 158** FROM THE DACM: TRAINING MARCHES ON
Training doesn't stop, even in a pandemic
- 162** FACES OF THE FORCE: STAFF SGT. DEBRA STOKES
Show up and try
- 164** CAREER NAVIGATOR: MAXIMIZING POTENTIAL
Senior Rater Potential Evaluations help identify future leaders
- 167** LESSONS LEARNED FROM A MIDDLEMAN
For liaison officer, much work and many rewards in helping to unify network modernization
- 172** SECURITY COOPERATION GOES PRO
Certification, education herald new era for the specialty field
- 176** FACES OF THE FORCE: MAJ. TOM BEYERL
Driving change in the AAW
- 178** ON THE MOVE
- 190** THEN & NOW: HELLO HELOS
In Army transport materiel, the best tech wins

From the Editor-in-Chief

The Industrial Base. What is it and why is it important, not only to the Army, but also to the nation? Regular readers surely know this (you'd better), but you can't just go to the store and buy a tank or missiles, secure communications gear, attack helicopters or myriad other weapons. Hence, we have an industrial base to make the things that nobody else can make.

To create this "arsenal of democracy," as some have called it, the government also created an organic national defense industrial base that provides services and goods different from those produced by the commercial industrial base. The vision, according to Army Regulation 700-90 "Army Industrial Base Process," is to create "a complementary and synergistic industrial base (commercial-owned and government-owned) that has the capability and capacity to satisfy the joint warfighter's materiel requirements in peacetime, wartime and during national emergencies."

As the vision states, the government is not in competition with commercial industry. Pieces of our systems do use what they call commercial off-the-shelf (COTS) products, but not whole weapons systems. The problem with using purely commercial equipment in military operations is that commercial items are simply not designed to operate in such a complex and harsh environment as the military often finds itself. Normal products aren't necessarily designed to be rugged, weatherproof or "hardened" against electro-magnetic radiation encountered in a battlespace. Plus, building products to such demanding criteria is simply cost prohibitive. No company in the world would build a fleet of products hoping they guessed right about what the military needs and the associated specifications. They would go out of business—and quickly!

No, almost everything the Army uses has components or subsystems that have been custom designed and built for specific military needs, using COTS products and partnering with commercial industry where ever possible. Where there is no industry for a particular item, the Army creates a depot, arsenal or ammunition plant—either a government-owned and government-operated facility or a government-owned and contractor-operated facility—to create, maintain and update the unique products it needs.

Because the Army provides the largest range of services resulting from its scope of capabilities (ammunition, communications, land vehicles), and supports other branches of the military, it should come as no surprise that the Army has the most facilities of all the services, almost 30 at last count, across the United States. The Army supports Air Force ground-based communications and electronics repair; ground and air missile systems for the Navy, Air Force and Army; Marine Corps tracked vehicles; and is the single largest producer of small arms ammunition for the U.S. armed forces at the Lake City Army Ammunition Plant in Independence, Missouri.

To see some of the facilities in action, and find out what they are working on, go to Army Material Command's Industrial Base Web Portal at <https://ibwebportal.ria.army.mil/>. But for now, to see what our Army Acquisition Workforce professionals are doing, look for the article "Modernizing Partnerships" (Page 14) from the U.S. Army Rapid Capabilities and Critical Technologies Office.

Find out how its streamlined approach to rapid prototyping is evolving partnerships with industry and accelerating development and delivery of needed systems. COVID-19 ain't slowing down defense! Discover what numerous companies have done to maintain safety and the manufacturing pace, even during these trying times, in "On a Dime" (Page 134). While we frequently focus on large corporations, many components and unique products come from small businesses. However, working with the Army isn't always easy. Learn what changes small business executives say are needed in the acquisition process to help them help us in "Small Business Perspective" (Page 8).

As always, if you have a suggestion for a story, comments or want to contribute to the magazine, please drop us a line at ArmyALT@mail.mil. We look forward to hearing from you.



Email Nelson McCouch III
@ armyalt@mail.mil

Nelson McCouch III
Editor-in-Chief

QUICK DRAW

Sgt. Brett Knox with the Kendrick Memorial Blood Center, located outside Fort Gordon, Georgia, takes blood from Patrick Young, an employee at Winn Army Community Hospital, as a participant in the DOD COVID-19 Convalescent Plasma Program in September. (Photo by Zach Rehnstrom, Winn Army Community Hospital)



A WINNING TEAM



The Army, ASA(ALT) and the U.S. defense industry work together to overcome COVID-19 difficulties.

This issue gives me another opportunity to praise the transparent and productive working relationship we've established with our commercial and organic industrial base partners, particularly throughout the COVID-19 pandemic. Earlier this year, the Army and our defense industry colleagues were presented with unique challenges, and we've faced (and continue to face) them together.

The Army has issued more than 25 policies implementing expanded authorities and acquisition flexibilities for our industry partners, allowing a rapid response from the Army contracting enterprise. These include increasing progress payment rates up to 90 percent for large businesses or 95 percent for small businesses and granting limited exemptions and waivers from certain federal contracting requirements.

In many cases, we've also accelerated payment schedules and shortened payment times from 30 days to 15. We worked hard to make sure the cash flow was managed in the industrial base and our industry partners did the yeoman's work in trying to manage that as well. Hundreds of millions of dollars, particularly with our large vendors, were advanced to subcontractors so they could stay afloat. This extraordinary teamwork is exemplary, and it's keeping both our testing and fielding schedules, as well as our programs and modernization priorities, largely on track.

For me personally, my daily report on the health of the industrial base that once spanned more than 80 pages is now a weekly report. Early on, I spent many hours each week in conference calls and on the phone with company executives. I continue this outreach today, but now have an opportunity to travel, although with limitations, and see firsthand the resilience of our industry partners. However, I continue to miss having engagements where I am able to visit multiple companies in one setting. Those 20 to 30 minutes together with company representatives in a face-to-face discussion at events—such as those held by the Association of the United States Army, the National Defense Industrial Association, the Aerospace Industries Association and other important organizations—will be hard to do again until the restrictions related to COVID-19 are resolved.

PEOPLE ARE THE MVPS

As we assess the industrial base and programmatic impacts of the pandemic, I am reminded once again that people are our most valuable asset. It's significant how we've learned to take better care of our people. As I write this, the Pentagon is currently at 50 percent staffing. Some observers have said that only essential people now go to work at the Pentagon; I tell them, *all* workers are essential. The question is, how do we make it effective for our workforce to do their jobs while remaining safe and protected? We've found numerous ways to do that, both within the Army and in industry. The

safety and health of our workforce—and the workforces of our industry partners—continue to be my top priority.

Within the acquisition, logistics and technology community, we've adopted a three-pronged approach to protecting our workforce and our warfighters. This includes:

- **Protect and prevent**—A comprehensive effort employing personal protective equipment, cloth face coverings, disinfecting technology and vaccine development.
- **Detect and screen**—A layered approach comprising diagnostic instruments and tests, mobile laboratories, thermal-imaging screening devices for fever detection, biosurveillance technology and contact tracing.
- **Treat and return to duty**—Deployment of therapeutics and other COVID-19 treatments to effectively treat and return personnel to duty.

For most people, the U.S. Army doesn't come readily to mind when they think about the national response to the COVID-19 pandemic. Still, the Army—and the acquisition community in particular—have a critically important role. Our COVID-19 Task Force monitors impacts to the commercial and organic defense industrial base, and addresses the impacts to manufacturing, engineering, service and supply chains as a result of company closures, minimal manning and other restrictions within the defense industrial base. In addition, the Task Force assesses programmatic impacts that result from industrial base constraints on Army testing and fielding of capabilities to our Soldiers.

TASKED WITH EXCELLENCE

The Task Force also has an important role in coordinating the Joint Program Executive Office for Chemical, Biological, Radiological and Nuclear Defense (JPEO-CBRND) response. The JPEO-CBRND is the primary acquisition office supporting the COVID-19 response and the primary DOD office supporting Operation Warp Speed, a federal interagency organization with a goal of producing and delivering 300 million doses of safe and effective vaccines, with the initial doses available by January 2021.

JPEO-CBRND has undertaken herculean efforts to support as needed, from helping develop capabilities in detection, diagnosis, treatment and vaccines for warfighters, to tools that increase situational awareness of the coronavirus.

When the pandemic hit, JPEO-CBRND re-prioritized and shifted to fielding the Army's testing and protection requirements, such



LOAD IT UP

In April, Oregon Army National Guard Soldiers loaded shipments of personal protective equipment (PPE) to be distributed throughout the counties and tribes of Oregon. These shipments of PPE were sent to Oregon by the U.S. Agency for International Development from Dubai. (Photo by Sgt. 1st Class Zachary Holden, Oregon Military Department)



PASS IT ON

Arizona Army National Guard service members pick up and deliver boxes of PPE gowns to local nursing homes and rehab centers in September at the Fabric Fashion Resources Innovation Center in Tempe. (Photo by Spc. Thurman Snyder, 123rd Mobile Public Affairs Detachment)

as diagnostics, mobile labs and personal protective equipment to highly impacted DOD locations. It then supported DOD's acceleration program providing medical countermeasures, including vaccines and therapeutics, diagnostics and testing capabilities, personal protective equipment, decontamination capabilities and disinfectants, and enablers such as needles, syringes, serology kits, collection kits, thermometers, initial standoff screening capability like thermal cameras and fill-finish capabilities, among others.

JPEO-CBRND and the U.S. Army Medical Research and Development Command collaborate frequently, leveraging each organization's unique skill sets as a force multiplier to deliver medical products and countermeasures to our nation's armed services. The U.S. Army Medical Research and Development Command focuses primarily on research and development to address non-CBRN issues such as endemic diseases. The JPEO-CBRND focuses on CBRN threats, working with government science and technology organizations and industry partners through contracts and other agreements to transition, develop and field critical CBRN medical countermeasures to our warfighters in operations across the globe.

CONCLUSION

Working together to combat COVID-19 is imperative, and no one organization or department can possibly tackle the complexities of the mission alone. The federal interagency partnership with industry relies heavily on coordination and collaboration among scientists, program management offices, company representatives, regulatory experts, legal counsel, contracting specialists and leadership to streamline efforts and deliver results for the benefit of the nation, the Army and the Soldiers we serve. 🇺🇸



WELL SUITED

U.S. medical personnel at the Landstuhl Regional Medical Center in Germany conduct training in April on the Powered Air-Purifying Respirator system, a full-body respirator used to safeguard staff members from contaminants. (Photo by Marcy Sanchez, Landstuhl Regional Medical Center)



COLD STORAGE

Maj. Juan Guzman, the chief of the Armed Services Blood Bank Center – Pacific Northwest, shows Assistant Secretary of Defense for Health Affairs Thomas McCaffery where the center stores the convalescent plasma it collects from donors who have recovered from COVID-19, during McCaffery's visit in July to the center at Madigan Army Medical Center on Joint Base Lewis-McChord in Tacoma, Washington. (Photo by John Wayne Liston, Medical Research and Development Command)



Illustration by Getty Images/exdez

SMALL BUSINESS PERSPECTIVE

DOD and the Army can do more to help, innovative firms say.

by Michael Bold

Tapping the innovation of small high-tech businesses has been a goal of DOD and the Army for some time now. How well has the effort gone? Army AL&T talked to some small businesses that range from 250 to five employees. They have some definite ideas about what government can do—and stop doing—to work better with them.

“Having come from industry and understanding the challenges associated with entering ‘the process,’” Dr. Bruce D. Jette, the assistant secretary of the Army for acquisition, logistics and technology and the Army acquisition executive, wrote in his column for the Fall 2018 issue of Army AL&T magazine, “I know firsthand that the Army must proactively and aggressively engage with innovators to see what new ideas, concepts, systems and subsystem components they can bring to the table. The next generation of enabling technologies required to achieve our modernization priorities may not currently exist—or they may, and not be apparent to the Army.”

This is by no means a comprehensive list, but it does provide a snapshot of the types of problems small businesses run into when working with DOD and the Army.

IT HELPS TO HAVE HELP

Tobin Fisher is co-founder and CEO of Vantage Robotics, a team of 20 Stanford- and Yale-educated engineers based in San Leandro, California, that builds ultralightweight and compact unmanned aerial surveillance drones.

After focusing on consumer and commercial opportunities, Vantage became involved with DOD through the Defense Innovation Unit’s (DIU) Short Range Reconnaissance (SRR) Unmanned Aerial Vehicle project. In August, DOD gave



five small drone manufacturers, including Vantage, permission to sell to the U.S. military and federal agencies, in the wake of last year’s ban—based on espionage fears—on these agencies buying Chinese-made drones.

Fisher, who had worked with DOD earlier in his career at other companies, found DIU invaluable in helping Vantage land the SRR project. “There’s great people involved that understand the challenge and are really working hard to do it,” he said. “[The credit] certainly goes to the work of DIU—I can’t say enough good things about them.”

“DIU did a spectacular job of really streamlining the process for working with DOD to the extent possible,” he said. “So I’d say, in general, it’s been a really great experience for us working with DOD. Having worked at the DOD over a long period of time, I have definitely seen a real massive change in the streamlining of approaches that DOD has. I think the big challenge for us is we want to develop

great products and we want to make a lot of them for our customers who can use them. Anything that’s other than that, in our minds at least, it’s a hindrance.”

For Lumineye, a five-person company based in Boise, Idaho, the initial push for working with DOD came from a Hacking for Defense class at Boise State University. Corbin Hennen, a co-founder and CEO of Lumineye, and Megan Lacy, a co-founder and chief design officer, were members of the Hacking for Defense team tasked by U.S. Special Operations Command (SOCOM) with coming up with a way to identify humans through radio frequencies. Through their work in solving the challenge, the students started Lumineye in 2017. (See “More than a Competition,” Army AL&T, Winter 2020, Page 94.)

The lightweight, compact device they created, the Lux, can provide first responders and warfighters “through-wall sensing” and can detect moving and still people from more than 10 meters away. It enabled Lumineye to win the xTechSearch 2.0

competition, sponsored by the Office of the Assistant Secretary of the Army for Acquisition, Logistics and Technology.

But, in establishing Lumineye and trying to work with DOD, the team discovered it had to find its own way. While at Boise State, Hennen talked his professors into sending him to the Hacking for Defense educators class at Stanford, thinking it would benefit his studies in cybersecurity. But the problem addressed to him wasn't about cybersecurity but about how to understand what threats lay behind a wall. "They talked more about the problems, about blind breaches and not knowing what's on the other side of a door or wall when they know they need to go in there," Hennen said. "And that really hit home with me because my uncle is a detective, and his partner was actually killed in a blind breach. And so I was, like, 'I want to help solve this problem.'"

"We ran into a lot of obstacles in the beginning, just because, one, we didn't have any funding," said Lacy. "So it's kind of hard to build hardware when there's no money. SOCOM was kind enough to give us some prototyping funds, so that was really helpful, because we did have some support there. But still, to kind of stop your master's programs and work on something full time is definitely challenging.

"And then also just figuring out how to start a DOD-compliant company. You've got to get your SAM.gov [System for Award Management] situated, your DUNS [Data Universal Numbering System] number. And all those things seem really easy now looking back at them, but in the moment, we had no idea what we were doing. ... So there was a lot of work that had to be done outside of just building the through-wall radar, which was kind of hard as it was."

The xTechSearch competition proved to be a bit of a life preserver for Lumineye. "The fact that they give you those small checks for travel throughout the process and then give you more funding for the six-month feasibility type of study and then the grand prize, I just think that program's really cool," Lacy said.

LPTA SOURCE SELECTION

Erin Horrell is chief growth officer for Intelligent Waves LLC, a 250-employee company based in Reston, Virginia, that provides IT solutions to both public and private sector clients. What's been her biggest headache working with DOD?

"Easy. LPTA [lowest price technically acceptable]. Sometimes, government makes the wrong choice by selecting this route, which could result in inferior outcomes and not meeting the

Just because you've been awarded work doesn't mean the check is in the mail.

mission requirements," she said. "To get the best value, contracts should set higher standards so contractors can deliver the value that government deserves, with full accountability and superior performance."

In an LPTA source selection, the award goes to the lowest-priced offeror who submitted a technically acceptable proposal. LPTA is not the optimal mechanism to procure IT services, Horrell said.

"Naturally, when there's an LPTA procurement, there's a race to the bottom. And when there's a race to the bottom, it becomes a price shootout among bidders, which may result in compromising the integrity of solutions or their quality," Horrell said. "Moreover, the winning contractor struggles to staff critical positions at the lower labor rates that they bid to win, and then is unable to fulfill the quality positions that the government deserves and expects to perform the work to the highest standards. This can result in



Erin Horrell



open vacancies and unhappy customers, which is self-defeating to mission success. We know we don't and can't control it, but in my opinion, it's not a good business model for professional IT services, where innovation, quality of the solution and the expertise of the people matter. LPTA should be relegated to commodity purchases, where all specifications are equal."

OFFSITE WORK FLEXIBILITY

Eric Strauss is director of business development at Connected Logistics, a Huntsville, Alabama-based Service Disabled Veteran-Owned Small Business with 35 employees that provides logistics, systems engineering and program support to DOD, the Army and other government contractors. "My recommendation would be focus less on counting butts in seats and more on

results and outcomes and how effectively the mission is being accomplished."

Requiring contractors to work onsite—most of his clients are based at Fort Belvoir, Virginia—limits the available talent pool, he said. He admits he's as guilty as anyone of wanting "to be able to see people in their seats as I walk down the hallway." But "that fear and concern clouds our judgment and our ability to really focus sometimes on what's most critical, which is not is that person working from my office from 8 a.m. to 4:30 p.m., but at the end of the week, did they get done what they needed to get done to be successful?"

Roughly half of his company's work is with the Army, the other half is with the Defense Logistics Agency (DLA). "I think it's fair to say that DLA has been more forward-thinking in its approach to offsite work," he said. One of the DLA projects requires a lot of travel to DLA sites in both the continental United States and abroad. The Connected Logistics-led team on that contract is based in eight states across several time zones. "And it works great," Strauss said.

"We couldn't have gotten to that point had DLA said we need everyone to be within 50 miles of Fort Belvoir," he said. "And that gave Connected Logistics and our teammates huge flexibility to recruit and hire and retain the most qualified personnel for the job, not those individuals that happen to be either closest to Fort Belvoir or most willing to say, OK, I'll spend an hour and 15 minutes in my car each day or each way traveling to and from Fort Belvoir."

EXCESS, REPETITIVE PAPERWORK...

Vantage's Fisher finds the paperwork involved in working with DOD to be a challenge. "I think whatever could be

done to allow the company to focus to the extent possible on innovation is, I think, best for both sides."

Not only is there a lot of paperwork, but it's often duplicating the same information on multiple forms, he said. "Occasionally, just the nature of working with a larger organization like the Army, we find ourselves filling out the same information in multiple different formats, and there being a bit of documentation overhead that obviously we prefer to minimize. But we also understand that it's a large organization and there's a lot of complexity they've got to manage. I think it's an adaptation process on both sides a little bit."

His company is good at building drones, and that should be its focus, he said. "Our expertise and our skill set is not understanding the details or the ins and outs how to navigate the Army's organizational structure. So the more that we can get help in understanding how to navigate the organizational structure and how to work effectively, which the Army or other parts of DOD can be extremely helpful for us."

...AND UNCERTAIN FUNDING

For a tiny startup like Lumineye, funding is key. But they've learned that, in dealing with DOD, just because you've been awarded work doesn't mean the check is in the mail.

"We spent the first two years bootstrapped," Hennen said. "We were working full time on this [developing their through-wall sensing technology], but we were working odd jobs as well to be able to pay our bills. we were doing pitch competitions and stuff to get funding around the state and everywhere else so that we could pay for new prototypes."

"And any of the additional funding, we were just trying to keep ourselves afloat;



Eric Strauss



Megan Lacy & Corbin Hennen



xTechSearch was some of our first real significant funding.” Lumineye has been able to get funding through some high-tech startup accelerators. “Initially, cash flow is extremely important. And even as you go on, for hardware and everything, if I need the tooling and everything else set up at a particular point in time and that cash flow doesn’t make the time that they originally intended it to, that can delay everything.”

Many startups and small businesses work on very tight, and often unforgiving, margins. “Every business has to make assumptions,” said Lacy. “But startups and small businesses have to make a lot of assumptions about their revenue model and where they’re going to get funding and when they’re going to get that funding. And you want those to be as accurate as possible because you’re spending money on different investments.

“I think one of the things that the DOD could be helpful with is faster payment and regular execution dates. With contracts, there’s always a little bit of wiggle room as to when they’ll actually start, versus when you’re selected for them. So having some consistency there would do wonders.”

BETTER-WRITTEN REQUIREMENTS

When DOD releases a request for proposal, and then materially changes the requirements after the request, it costs companies money, said Strauss of Connected Logistics. He noted that, in the week before he talked with Army AL&T, he had seen two different requests amended by DOD “that significantly changed the requirements” before both were canceled.

“What it means from industry’s perspective is additional time and effort spent to revise and resubmit proposals. And we’re one of X number of bidders. If you look across all bidders on a given opportunity, you probably easily have 1,800 to 2,000 hours being spent by industry to revise these proposals. On one hand, the government may look at it and say, well, we need to make sure the requirement is right. But perhaps in this case, with additional time spent upfront by the government, it might have saved 2,000 hours on the industry side, which in the end, saves the government money.”

CONCLUSION

Much has changed since the Army convened its first innovation summit in 2016. DOD, working with Congress, received new authorities beginning with the 2017 National Defense Appropriations Act to get small, innovative businesses on board. Despite the paperwork and the bureaucracy faced by the companies that Army AL&T talked to, their work would have been much harder, if not impossible, if the government had had to rely on traditional Federal Acquisition Regulation-based contracting.

New organizations like the U.S. Army Futures Command and DIU, and new efforts to reach small businesses like the xTech-Search, will enable a more diverse ecosystem to meet the Army’s evolving needs. For these businesses and others like them, trends are promising, but more work needs to be done.

For more information, contact the author at mbold@networkrunners.com.

MICHAEL BOLD provides contract support to the U.S. Army Acquisition Support Center. He is a writer-editor for Network Runners Inc., with more than 30 years of editing experience at newspapers, including the McClatchy Washington Bureau, The Sacramento Bee, the San Jose Mercury News, the Dallas Morning News and the Fort Worth Star-Telegram. He holds a Bachelor of Journalism degree from the University of Missouri.



NOT YOUR MOTHER'S MICROWAVE

RCCTO will field a prototype Indirect Fire Protection Capability – High Power Microwave at the platoon level in fiscal year 2024. (Photos courtesy of RCCTO)

MODERNIZING PARTNERSHIPS

The Army Rapid Capabilities and Critical Technologies Office's streamlined approach to rapid prototyping is evolving partnerships with industry.

by Nancy Jones-Bonbrest

It's October 2019 and China unveils a hypersonic missile, Dongfeng-17, along with a new stealth combat drone, during a military parade. Two months later, Russia announces its successful deployment of Avangard, a hypersonic glide vehicle it claims can fly 27 times the speed of sound. Thousands of miles away in the Middle East, ongoing drone attacks demonstrate how low-tech weapons can create high-impact concerns.

As U.S. adversaries continue to modernize and adapt at a rapid rate, the U.S. Army is pursuing its own aggressive modernization strategy to prevail in current and future conflicts. One piece of that strategy requires rapidly transitioning technologies from industry and the science and technology community, developing them into combat-capable prototypes and delivering them to operational units on an expedited schedule. To accelerate this task, Army leaders empowered the Army Rapid Capabilities and Critical Technologies Office (RCCTO) with the authority to accelerate development and delivery for several of the country's most critical capabilities, including hypersonics, directed energy and disruptive technologies.

Key to executing this vision is the RCCTO's relationship with industry. Instead of following a traditional acquisition path, the organization is asking vendors to take a leap of faith and develop first-of-a-kind prototypes in a limited number and on an expedited delivery schedule, often supplemented by internal research and development funds.

The prototypes not only equip the Army with a new line of weapons and inform future programs of record, but also give Army leaders options to incorporate new technologies and approaches in an increasingly complex environment. By investing

their resources and intellectual property—often through deep networks of prime contractors and subcontractors throughout the industrial base—companies have an increased stake in the outcome of the rapid prototyping process.

The approach isn't completely new, but more of a streamlined version. It's still Army acquisition—with all of the responsibilities and safety concerns that come with providing a weapon to Soldiers. Yet in tailoring the traditional acquisition process to include unique authorities, abbreviated chain of command and rapid navigation or exemption from many of the traditional processes that govern a program of record, the RCCTO created a new relationship with industry that helps to break down barriers and allows innovation at the speed of relevance.

In this article, you'll read about several of the key individuals at RCCTO who are implementing this new way of business, working with industry partners to execute rapid experimental prototypes and field residual combat capabilities to Soldiers.

The RCCTO project office leads discuss how rapid prototyping is helping the Army move faster and be a better partner for industry as they work together to deliver new weapons and technologies.

DR. CRAIG ROBIN, DIRECTED ENERGY PROJECT OFFICE

The Directed Energy Project Office is charged with delivering the Army's first meaningful laser weapon for tactical use: 50 kilowatt (kW)-class lasers integrated on a platoon of Strykers by the 2022 fiscal year. The project office is also prototyping a 300 kW-class Indirect Fire Protection Capability – High Energy Laser for delivery to a platoon and partnering with the Air Force to deliver an Indirect Fire Protection Capability – High Power Microwave prototype, both in the 2024 fiscal year.

Robin: Directed energy is a completely new technology for the Army. Most other areas of modernization focus on the



SHOW AND TELL

In July, the RCCTO welcomed Secretary of the Army Ryan McCarthy to its new headquarters building at Redstone Arsenal, Alabama.

improvement of an existing weapon system, but directed energy represents a revolutionary change to the battlefield, while being a complementary capability to existing air defense weapon systems. Since directed energy is an emerging technology, the community is relatively small. This familiarity helps to enhance collaboration and coordination across the services and industry.

I began my career in the Air Force Research Laboratory, moved to industry, and then came back into the government with the Army. I know what it's like to call a point of contact in the government and not get a response. And I know what it costs to pull together a white paper. Experience on both sides of this business gives me a unique perspective and the ability to effectively manage stakeholders across government and industry.

Lessons learned: The acquisition model we use calls for co-investment from industry in the early stages of prototype development,

A TIMELINE
RCCTO INDUSTRIAL BASE

- AUGUST 2016**
Secretary of the Army establishes the Rapid Capabilities Office (RCO).
- DECEMBER 2016**
RCO office is chartered; directed to field electronic warfare (EW) capabilities to Europe.
- JANUARY 2018**
RCO fields EW prototypes to the 2nd Cavalry Regiment.

leading to a decision point for Army senior leaders with three outcomes: make more and enter into a program of record; cancel the effort; or send it back for more development. In executing this, we often perceive a “valley of death” as the insurmountable obstacle in keeping directed energy from transitioning to a program of record. Sometimes this is a self-imposed limitation and we are finding new ways to cross the bridge, to connect the science and technology communities in both government and industry with the program of record community.

At the same time, the RCCTO is organized to leverage this enthusiasm in industry as well as investment from other government agencies and authorities, like other-transaction authority, granted by Congress. We will transition a revolutionary and new weapon system to the warfighter by assembling the right team and providing senior leaders with a credible path to a capability.

Recent wins: All of our efforts are on track; holding steady on schedule and budget. Every day that our team battles through COVID-19 and continues to meet the mission is a win.

What’s next: Now we execute the programs approved by Army senior leadership and deliver directed energy capability to our Soldiers.

MIKE FOSTER, RAPID ACQUISITION PROTOTYPING PROJECT OFFICE

The Rapid Acquisition Prototyping Project Office accelerates acquisition and technology assessments to move prototypes that fall outside of hypersonics and directed energy through the RCCTO and into the hands of Soldiers. The most recent projects include hybrid power solutions for combat vehicles and advanced radar solutions.

Foster: Rapid is in my office name so moving fast is key. Our project timelines typically span two years or less to fielding. That’s from contract award to delivery of a prototype to Soldiers. In developing a prototype, we take some of the risk out for the project manager who will oversee the prototype once it becomes

a program of record, and we partner with the project manager throughout the process.

The prototypes we are delivering provide a proof of concept—does it work? For example, we are working to rapidly prototype hybrid electric drives into Army combat vehicles as a key step in scaling up this widely available commercial technology. With this effort we will jump-start advanced hybridization of Army platforms and encourage industry to invest in these products. We’re starting with the Bradley vehicle as a surrogate. In working this effort, we already know that the battery location in the prototype vehicle is not where it will be for future uses. And that’s OK, because instead of spending months on designing where those batteries will go, we’re able to build a prototype and demonstrate that the technology works. Then, as the program of record comes along, they can look at the most effective place to put the batteries on the vehicle. That approach allows us to move out with delivery in under two years. And, in those two years, the batteries will be newer, more powerful and probably smaller for easier integration.

Lessons learned: This concept is new to industry partners who are used to traditional acquisition. So where they are used to hearing, “Design this,” we are saying, “We want it to do this, offer your expertise on how to do it.” We still make sure that it meets safety standards and we still have requirements. For industry, this process can be a shock, but it actually works very well for them. But communication is key. You have to be able to communicate and let them know exactly what the expectations are.

RCCTO is asking vendors to take a leap of faith and develop first-of-a-kind prototypes in a limited number and on an expedited delivery schedule.

APRIL 2018

RCO launches Army Signal Classification Challenge scoping artificial intelligence in support of EW signal classification.

MAY 2018

RCO partners with Project Manager Towed Artillery Systems to double the range of a modified M777 howitzer.

DECEMBER 2018

The RCO and Program Manager Electronic Warfare & Cyber win the 2018 David Packard Award for Excellence in delivering EW prototypes to Europe.

Recent win: The Rapid Acquisition Prototyping Project Office and the RCCTO recently awarded an other-transaction authority prototype agreement for hybrid electric drives in an Army combat vehicle. The effort from contract award to delivery is expected to take 24 months. The Bradley is being used because of the size of the engine, which is smaller than other tracked vehicles and can then scale up to be applied to other platforms, including future vehicles. There are multiple benefits to [hybrid electric drives], including fuel reduction, increased automotive performance, increased survivability (by reducing the thermal and acoustic signature of the vehicle), better acceleration capability and improved lethality. We see a lot of potential to benefit other Army platforms in the future.

What's next: We will continue working closely with the Program Executive Office for Ground Combat Systems to integrate the hybrid electric system into two Bradley A2s. Once the prototyping effort is over and the two Bradley hybrid electric vehicles are complete, we will conduct government acceptance testing prior to handing it off to the Program Executive Office for Ground Combat Systems.

ROB MONTO, ADVANCED CONCEPTS & EXPERIMENTATION PROJECT OFFICE

Within the RCCTO is a dedicated cell called the Advanced Concepts & Experimentation (ACE) Project Office. Its mission is to rapidly develop, test and transition advanced technologies to address high-priority items identified by Army leaders. Serving as a quick reaction cell for rigorous research and analysis, prototyping and assessment, ACE acts as a portal to national experts, academia, industry and startups.

Monto: We're the Swiss Army knife of the organization. ACE is the closest thing to the science and technology part of the RCCTO, covering a wide spectrum of topics. We consider all concepts and ideas and provide information so senior leaders can make better informed decisions on emerging technology. We do that multiple different ways: by hosting innovation days, working

We strive to develop rapid prototypes, enabling Soldiers to assess the items before we decide to invest in large quantities or develop formal requirements.

with the science and technology community, and engaging with academia. Our mission is to look for innovation and find ways to introduce innovation into the Army.

Lessons learned: Industry sees us as a conduit to getting good ideas in front of Army leadership. And that's a good thing. But in working with companies—many of which are not traditional defense contractors—we have to be careful to communicate each step of the process because it is not traditional acquisition. What we do is not cookie-cutter, so we are careful to say, "This is how we think it will work."

Recent wins: We held two innovation day events—one in September 2019 and one in February 2020. The intent of innovation days is to allow companies to rapidly pitch new technologies and ideas that reduce near- and mid-term operational risks against near-peer adversaries. If selected by a board of Army leaders, the companies presenting these ideas could be awarded a contract to develop a prototype and potentially deliver an operational capability to the Army. Out of those events, we had almost 900 submissions and close to 80 were pitched to Army leaders and decision-makers. From those, 21 are in the process of moving forward either in concept refinement or for a possible contract award and two are already on contract to produce a rapid prototype. The technologies we selected are all on a one- to three-year timeframe for delivering prototypes to Soldiers.

DECEMBER 2018

Secretary of the Army signs new charter reestablishing the office as the Rapid Capabilities and Critical Technologies Office (RCCTO) with a focus on hypersonic, directed energy and space.

APRIL 2019

Lt. Gen. L. Neil Thurgood receives his third star and assumes duties as the director of hypersonic, directed energy, space and rapid acquisition, which includes the RCCTO.



FAST PITCH

Innovation day in Austin, Texas. Innovation days allow companies to pitch new ideas and technology rapidly.

What's next: Executing, executing, executing.

ROBERT STRIDER, ARMY HYPERSONICS PROJECT OFFICE

Responsible for delivering the prototype Long Range Hypersonic Weapon to an Army battery by the 2023 fiscal year, the Army Hypersonics Project Office is also helping create a new U.S. industrial base for hypersonic weapons by moving production out of government laboratories and into commercial manufacturing.

Strider: The Army Hypersonic Project Office is working at a pace to rapidly field a prototype system. To do this, we pulled together a hand-picked group that has the talent in their specific areas and are not constrained with milestone decision processes

that would slow this down. At the same time, we are making sure that the system we provide is safe to operate and has been tested to perform as designed.

We are creating a new industrial base by transitioning the technical knowledge from Sandia National Laboratories to industry. Sandia has had the key responsibility of developing the Common Hypersonic Glide Body (CHGB), producing it and testing it for several years. There has been some excellent work to move this knowledge to our industry partners. To date, Sandia has trained some 66 personnel on the unique production methods used for the CHGB, and this will be the foundation to move the production out of the lab and into industry. Even with coronavirus restrictions, the team has managed to find ways to be successful, stay safe and stay on schedule.

Lessons learned: In working with industry, we keep it very transparent and all program reviews are done jointly. We are partnered with the Navy to execute hypersonics through use of a common glide body, missile design similarities and joint test opportunities. We are all truly one team. We don't pay attention to the color of someone's badge, but look to the capability and talent they bring and make the most use of it. Being fully transparent with our industry partners has created an open communication atmosphere.

Recent wins: The recent joint flight test with the Navy, Army, Office of the Secretary of Defense and Missile Defense Agency in March was a huge success in demonstrating the capability of the CHGB. It will also provide a wealth of data to anchor our models and simulations. Another win is the use of Soldier-centered design and Soldier touch-point events, where we work with Soldiers who will use the systems and bring them in to a virtual environment to get their input and influence the design of the equipment. Getting Soldier feedback early in the process and adjusting the design with their ideas is key to a successful delivery.

What's next: We have two major tests with our joint partners in the near future. The first will be an extended range test to obtain

JULY 2019

Army RCCTO issues a contract to rapidly prototype and field the first combat-capable laser weapon system, a 50 kilowatt (kW)-class laser on a platoon of four Stryker vehicles in the 2022 fiscal year.

AUGUST 2019

Army RCCTO issues two contracts for its Long Range Hypersonic Weapon supporting the design, integration and production work that enables a series of flight tests and leads to fielding in the 2023 fiscal year.

more data on the performance of the CHGB. The second will be the first test of the Army’s fielded configuration and will be the first test with the new booster that both the Army and Navy will use. Another monumental event will be providing the launchers and the command and control to the Army’s operational unit later next fiscal year.

JULIAN WILLIAMS, COMPUTING AND ELECTRONICS SECURITY DOMINANCE

Computing and Electronics Security Dominance maps advanced technologies from innovators to Army warfighting capability gaps to develop rapid prototyping strategies to get emerging technologies to Soldiers.

Williams: The RCCTO charter provides our team with unique authorities, including the ability to forego creation of many of the standard DOD 5000 series documents. We are able to engage directly with technology providers in search of innovative state-of-the-art capabilities. We strive to develop rapid prototypes, enabling Soldiers to assess the items before we decide to invest in large quantities or develop formal requirements. This enables us to capture Soldier feedback directly and immediately to shape and influence future requirements. The RCCTO charter gives us the ability to move rapidly while engaging with warfighters and top technologists for input and to deliver capabilities much more quickly than the traditional acquisition process.

Executing a well-defined rapid prototyping process with direct Soldier input, coupled with innovative technologies, allows us to rapidly deliver capability to the warfighter.

Lesson learned: Communication is key. We strive to have frank, honest and transparent discussions so we can formulate a concept and then decide, as a team with industry, on the best path that is technically achievable and worthy of a prototype. We aim for a relatively short (normally 12 months or less) development-to-delivery period. Maintaining frequent, continuous and open communications with all stakeholders is of paramount importance in achieving success.

Recent wins: We are developing close relationships with many of the top performers in the field of cyber and computing and we are learning more each week. The differences are seen in the discussions we are able to have with our industry partners, allowing them to help us shape the prototype developments without formal requirements, but rather, based on the current technology and our collective inputs, to address a capability gap or enhance current systems.

What’s next: We are a relatively new office in the process of defining our cyber outreach and engagement strategy. Our goal is to leverage technology providers within government, academia and industry circles to garner the “best of breed” technologies to meet our challenges. We place special emphasis on engaging with small businesses and nontraditional defense industry providers to deliver new and innovative solutions to Army capability gaps and improve current systems.

Our mission is to look for innovation and find ways to introduce innovation into the Army.

PETE MANTERNACH, COUNTER-SMALL UNMANNED AIRCRAFT SYSTEMS PROJECT OFFICE

The secretary of the Army established the Joint Counter-Small Unmanned Aircraft Systems Office (JCO) unmanned aircraft systems solutions. The RCCTO works in support of the JCO, as the acquisition and resources lead.

SEPTEMBER 2019

Groundbreaking for one of the nation’s first hypersonic facilities.

SEPTEMBER 2019

RCCTO holds its first innovation day, hearing 40 pitches with the goal of fast-tracking the best ideas into prototypes.

DECEMBER 2019

RCCTO awards its first innovation day contract to TRX, a small Maryland-based business.

In tailoring the acquisition process, the RCCTO created a new relationship with industry that helps to break down barriers and allows innovation at the speed of relevance.

Manternach: In order to keep pace with the rapidly evolving [small, unmanned aircraft system] threat, the services found separate solutions to meet immediate needs. This led to disparate systems with sustainment and training challenges. In January, DOD established the JCO to align these efforts. Since then, our main focus has been on establishing efficiencies and commonality across the services. In June, DOD leaders approved results of an evaluation of counter-small unmanned aircraft systems capabilities currently in the field and proceeded with seven interim systems and associated command and control.

Now, we're working with industry to advance these interim systems against a larger threat set and bring in new systems to provide a scalable and layered counter-small unmanned aircraft systems defense. Following the selection of interim systems, we are focusing on identifying and consolidating technology developments into a DOD road map. The road map will align science and technology and research and development efforts among the services. From there, we will decentralize execution by identifying the appropriate acquisition organization to develop and transition those into joint capabilities and enduring solutions.

Lessons learned: To find efficiencies, we have to first make sure there is not overlap in investments among the services. By centralizing planning and priorities, and decentralizing execution, our industry partners should be better able to focus internal research and development. In other words, industry will have an aligned strategy instead four separate service strategies. We think this centralized prioritization model will help make more efficient use of DOD development dollars and align efforts towards the evolving [small, unmanned aerial system] threats.

Recent wins: Selecting the counter-small unmanned aircraft systems was a big first step. Those systems, seven counter-small unmanned aircraft systems and three command-and-control systems, will help standardize counter-small unmanned aircraft systems capabilities for the DOD. This gives the DOD a range of joint capabilities that they can immediately procure and use as protection, as we continue to streamline layered, incremental improvements.

What's next: Continue to identify efficiencies in development, conduct testing and develop procurement pathways with the service acquisition organizations. We will continue to engage industry partners to innovate solutions and align funding to emerging threats. We'll also work with the services to provide solutions for the DOD, other government agencies and our allied partners.

For more information, go to <https://rapidcapabilitiesoffice.army.mil>.

NANCY JONES-BONBREST is a public communications specialist for RCCTO. She has written extensively about Army modernization and acquisition for several years, including multiple training and testing events. She holds a B.S. in journalism from the University of Maryland, College Park. A frequent contributor to Army AL&T, her articles, "Every Minute Counts" and "Innovation Days: Concept, Prototype, Deliver," appeared in the Summer 2020 edition.

FEBRUARY 2020

RCCTO holds its second innovation day, hearing 38 pitches for new technology.

MARCH 2020

U.S. Navy and Army jointly execute the launch of a common hypersonic glide body, which flew at hypersonic speed.

JUNE 2020

RCCTO moves into its new headquarters building at Redstone Arsenal, Alabama.

AUGUST 2020

RCCTO holds ribbon-cutting ceremony for its new headquarters building.



FIBER OPTICS

Advanced Functional Fabrics of America (AFFOA) research-and-development technician Chhea Chhav monitors a fiber draw on one of AFFOA's five fiber-draw towers. Draws need to be monitored throughout the draw process to ensure fiber's reliability and success. (Photos by Greg Hren, AFFOA)

THREAD LEVEL GREEN

DOD looks to create value and capabilities for the Soldier while helping rebuild the once-dominant U.S. textile industry with automation and innovations in advanced manufacturing.

*by Jeffrey Pacuska, Clay Williamson, Suzanne Horner
and Stephen Luckowski*

Domestic textile manufacturing capacity is rapidly diminishing as a result of globalization. A healthy domestic industrial base is essential to meet wartime surge production requirements and to ensure that our warfighters are equipped with the most advanced uniforms and other textile-based combat equipment in the world.

The Office of the Secretary of Defense (OSD) Industrial Base Analysis and Sustainment (IBAS) office is dedicated to ensuring that DOD is positioned to more effectively and efficiently address industrial base issues and support the national security innovation base. The Textile Automation to Enhance Domestic Military Production program is an IBAS initiative to spur modernization in the domestic clothing and textile defense-industrial base, an industry that has largely relied on the same machinery and manufacturing techniques for decades.

The U.S. textile industry is also facing diminishing workforce availability and increased global competition, primarily from Asia. Investing in new manufacturing technologies that offset workforce losses and create higher value products in the United States will promote global competitiveness in existing textile markets while lowering the risk for technology investments. The payoffs to DOD for this investment are a more robust supply chain that minimizes cost to the services, and advanced capabilities for Soldiers through next-generation “smart” textiles being manufactured commercially in the United States.

To this end, the IBAS office has partnered with the Product Manager for Soldier Clothing and Individual Equipment (PM SCIE), within the Program Executive Officer for Soldier (PEO Soldier), and the U.S. Army Combat Capabilities Development Command – Soldier Center (CCDC-SC) to execute the Textile Automation to Enhance Domestic Military Production program. While there are many elements of the textile supply chain that could benefit from new technology, this effort will initially focus on the automation of textile production and the insertion of robotic cut-and-sew technologies in the final assembly. In doing so, it will take cues from efficiencies gained in the microprocessor industry.

This effort will provide the foundation for innovation and technological dominance required to support the National Security Strategy (NSS) and National Defense Strategy (NDS) in three key areas:

- Assess the financial and production capability of current domestic textile producers that support key product lines from fiber to finished product, ensuring resiliency and redundancy throughout the relevant supply chains (fiber, fabric and assembly). These assessments will allow the IBAS program to prioritize limited resources toward more vulnerable sectors of the industry.
- Develop prototype machinery and production lines that address emerging operational needs and existing technology gaps to drive affordability and availability across the domestic defense industrial base. By comparison, overseas advancements in textile technology may not be available to DOD, potentially creating a situation where peer competitor forces have advantages in area such as detectability and environmental and ballistic protection.
- Expand the current United States manufacturing industrial base to meet critical material supply requirements through capability and skill improvements with traditional and nontraditional suppliers through innovative financial investments and technology infusion. The United States must maintain surge production capacity for textile products to support rapidly emerging wartime demand. This will not be possible without modern factories and trained workers.

BERRY-REGULATED

From the 1970s until 2004, world textile trade was governed by the Multi Fiber Arrangement (MFA). This consisted of a system of quotas that limited bilateral

imports of specific types of textiles and apparel with the purpose of preventing any one country from dominating the textiles export market. Phasing out of that agreement began in 1995, and it was eliminated in 2005 as the textile trade came under the jurisdiction of the World Trade Organization.

The defense textile industrial base has always surged to meet wartime requirements. This default expectation may no longer be possible.

In 1995, the United States was the world’s leading apparel maker, accounting for 13 percent of the world’s textile market. However, by 2017 that number had dropped to 3 percent. The second-order effects to the United States have been the loss not only of manufacturing competencies but also of more skilled design, engineering and production skills across supporting industries.

Textiles form an integral component of many defense and commercial systems in ways that don’t appear obvious to the common observer. While uniforms, tents, parachutes and backpacks are certainly fabric-based, textile applications also include composite and non-woven structures. Kevlar body armor, fiberglass in drones and carbon fiber in advanced aircraft are all textile-based applications.

For DOD textile products, the government retains domestic capability through protected supplier arrangements such as the Berry Amendment and the Javits-Wagner-O’Day Act. These protections have also resulted in a fragile DOD supply chain, for which the government is often the only customer.

The Berry Amendment requires DOD to give preference in procurement to domestically produced, manufactured or home-grown products, most notably food, clothing, fabrics and specialty metals. No textile-based product procured by DOD can contain any foreign-made fiber or be processed otherwise overseas. The Berry Amendment-protected DOD supply chain represents the output of 12 percent of textile mills, 21 percent of textile product mills and 26 percent of apparel production, and these are generally seen as an essential element of the remaining U.S. textile, apparel and footwear industrial base.

Increased automation and assembly capabilities would help to add flexibility to the Berry-protected supply chain, allowing for greater diversity in production and potential expansion into non-DOD markets. Moreover, the U.S. textile industry is identified in a report drafted by the Interagency Task Force in Fulfillment and Strengthening the Manufacturing and Defense Industrial Base and Supply Chain Resiliency of the United States” (September 2018). With the large movement of textile manufacturing to cheaper foreign markets—and fewer domestic companies producing textiles—sources for shelters, clothing, individual equipment and composites, such as body armor and helmets, face greater risk. Currently, only a few domestic sources can provide the material requirements for defense-specific textiles.



MATERIAL DIFFERENCES

Advanced manufacturing techniques can introduce technology into fabrics, like this swatch with integrated LED fibers. AFFOA's product development team continuously innovates around incorporating fiber technology seamlessly into fabrics.

CHANGING THE PLAYING FIELD

At the materiel level, the equipment used in most fabric manufacturing and cut and sew operations has not changed substantially in over a century. These machines are highly manpower-intensive, not upgradable and ill-suited for incorporation of eTextiles, smart materials or other next-generation technologies. Most of the mills and factories, particularly in the DOD supply chain, operate on extremely tight margins that rarely offer them the ability to innovate or upgrade existing equipment, both of which are critical

to remaining viable and sustainable. Not only does this limit or threaten DOD's current and future procurement activities, it all but eliminates the possibility for manufacturing advanced fiber- and fabric-based technologies.

While automation will certainly help to shore up elements of the textile value chain, the gains to be made in traditional textiles may be limited because of the significant losses to global competitors through the last three decades. A solution may be to leverage U.S. innovation by creating a new textile paradigm based on microelectronics and advanced materials that could provide operational advantages to warfighters, and new commercial consumer markets.

Examples on the DOD side might include Soldier-worn sensors, unmanned aerial vehicles with communication or detection components built into their structural elements, and materials that change shape or appearance based on environmental or physical conditions. Commercial applications could include such things as patient-monitoring technologies for hospitals, monitoring and recording systems built into the panels on new lightweight vehicles, or adaptive insulation and moisture control for construction applications.

Additionally, a new high-tech workforce will be required to support building the infrastructure and operating automated textile manufacturing facilities. Advanced skills will be needed for textile manufacturing, finishing, programming digital machine interfaces and managing intelligent-sourcing decisions in more complex, higher value textile supply chains.

Future Soldier systems objectives include lightening the Soldier's load, capitalizing on lessons learned after years of fighting, and developing modular, agile materiel solutions that take advantage of advances in sensor technology and materials engineering.

To achieve these ends, the Army needs access to a skilled workforce and modernized industrial base capable of achieving advanced designs and developing novel industrial capabilities. Substantively enhancing the capabilities of the domestic textile industrial base is a major challenge. Through the Textile Automation to Enhance Domestic Military Production program, the OSD IBAS office is combining its manufacturing base expertise with the product knowledge and buying power of PM SCIE and the technical acumen of CCDC-SC.

Working together with forward-leaning industry partners, the program team expects to begin affecting change toward a more

modernized domestic textile industry. However, spurring change in an industry that is slow to change and limited in resources is likely beyond the scope of a single DOD program effort. Therefore, as this effort evolves, it will lean more heavily on both a widening circle of industry partners and other DOD investments in manufacturing technology that are currently ongoing to help develop new technologies and providers. Investments made by the OSD Manufacturing Technology office in functional fibers at the Revolutionary Fibers and Textiles Institute and robotics at the Advanced Robotics for Manufacturing Institute are developing

enabling technologies to enhance Soldier performance and add value to what were formerly commoditized products. Inclusion of these new technologies will require automation to make the technology affordable and accessible.

CONCLUSION

By investing in and working with industry, the Textile Automation to Enhance Domestic Military Production program will enable the commercial rollout of automated manufacturing solutions by building a public-private collaboration to strengthen the U.S. industrial base while also making production more economically viable for all customers. Furthermore, these investments will serve to establish U.S. leadership in this critical area, thereby improving domestic competitiveness.

This will create a growing need for a high-tech workforce in burgeoning, lasting markets, serving both the government and commercial industries. Because the domestic textile industry operates on extremely low profit margins and, as a result, is collectively limited in its access to internal research and development funding, it is highly unlikely that manufacturers would make the required capital investments in automation for the limited DOD market alone. Given partnership and investment through this OSD program and other federal investments, however, it may be possible to modernize the sector. By focusing on near term gains through automation of legacy textile and textile product production, the program may demonstrate the increased value proposition for technology insertion across a wider swath of the entire industry.

Of course, the initial reaction of many is that an increase in production automation and robotic assembly would reduce existing jobs across the textile industry. However, a 2017 study by the U.S.

Textiles form an integral component to many defense and commercial systems.

Department of Commerce’s Bureau of Industry and Security titled “Textile and Apparel Assessment” paints a different picture. Of the 571 domestic manufacturers surveyed, 61 percent reported difficulties hiring and retaining employees, specifically “production line workers such as operators and machine technicians.” The reasons for this are many, but include facility locations that lack a large labor pool from which to draw, as well as competition for that same labor pool. Further, the study cites the lack of available workforce as the number one condition limiting their ability to increase manufacturing utilization rates to 100 percent in the event of a surge in demand. These factors seem to indicate that increased domestic manufacturing is not hampered by lack of jobs, but rather by the lack of people to fill them. Increased automation and the implementation of new technologies could help to fill these gaps.

The impacts to defense-related procurement are significant, both in the ability to surge the industrial base in times of conflict and also to integrate advanced capabilities into uniforms and equipment that can increase Soldier effectiveness. The defense textile industrial base has always surged to meet wartime requirements, but this default expectation may no longer be possible. Labor, fiscal and global market constraints limit future adaptability.

The incorporation of increased automation and robotic assembly can help to offset

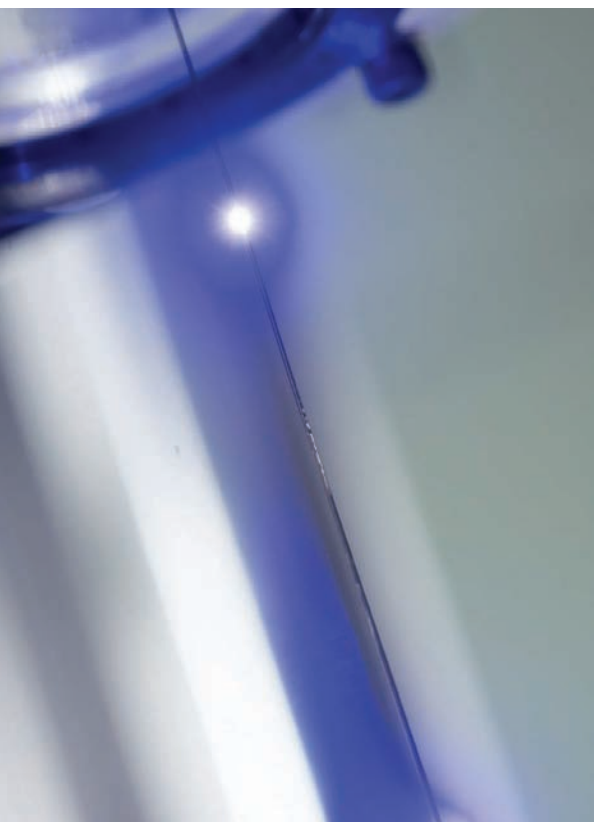

OUT OF THE BLUE

There are many potential uses for fabric containing advanced monofilament LED fibers, which are able to emit and receive data.

industry production and innovation challenges resulting from a shrinking labor pool and legacy machinery. Meanwhile, these new innovations can both increase domestic competitiveness and create the adaptability needed for future Army requirements. The successful venture between PM SCIE, CCDC-SC and OSD IBAS in the Textile Automation to Enhance Domestic Military Production program will help foster these industry changes.

For more information, visit the Office of the Secretary of Defense (OSD) Industrial Base Analysis and Sustainment (IBAS) website at: <https://www.businessdefense.gov/IBAS/>.

JEFFREY PACUSKA is the program manager for Future Technologies Integration at the U.S. Army CCDC-SC at Natick, Massachusetts, and the technology and systems integration lead at the Defense Fabric Discovery Center (DFDC) at the Massachusetts Institute of Technology Lincoln Labs. He previously worked as a CCDC-SC team leader and portfolio manager and as an assistant product manager and project engineer within the PEO Soldier. He holds an M.S. in materials system engineering management from Worcester Polytechnic Institute and received a B.S. in biochemistry from Tufts University. He is certified as a Project Management Professional, and is a member of the Army Acquisition Corps (AAC).

CLAY WILLIAMSON is the future programs officer for PM SCIE at PEO Soldier and serves as DOD Soldier Systems Sector Lead for Executive Order 13806. He retired as a major from the Army, and was an assistant product manager and then co-founder and president of a publicly traded defense industry company. He has an M.A. in procurement and acquisition management and a B.A. in industrial-organizational psychology. He is certified as a Project Management Professional and is a member of the AAC.

SUZANNE HORNER is the lead systems engineer for Soldier Clothing and Individual Equipment at PEO Soldier at Fort Belvoir, Virginia. She served as an assistant director technical management for Project Manager Soldier Survivability, managing research and development programs for the Soldier Protection portfolio. She received a M.S. in mechanical engineering from the University of Massachusetts and is a member of the AAC.

STEPHEN LUCKOWSKI is a directorate advanced manufacturing associate at the Combat Capabilities Development Command Armaments Center at Picatinny Arsenal, New Jersey. His primary roles are program manager of the DOD Revolutionary Fibers and Textiles Manufacturing Innovation Institute and providing strategic planning for the Armaments Engineering Analysis and Manufacturing

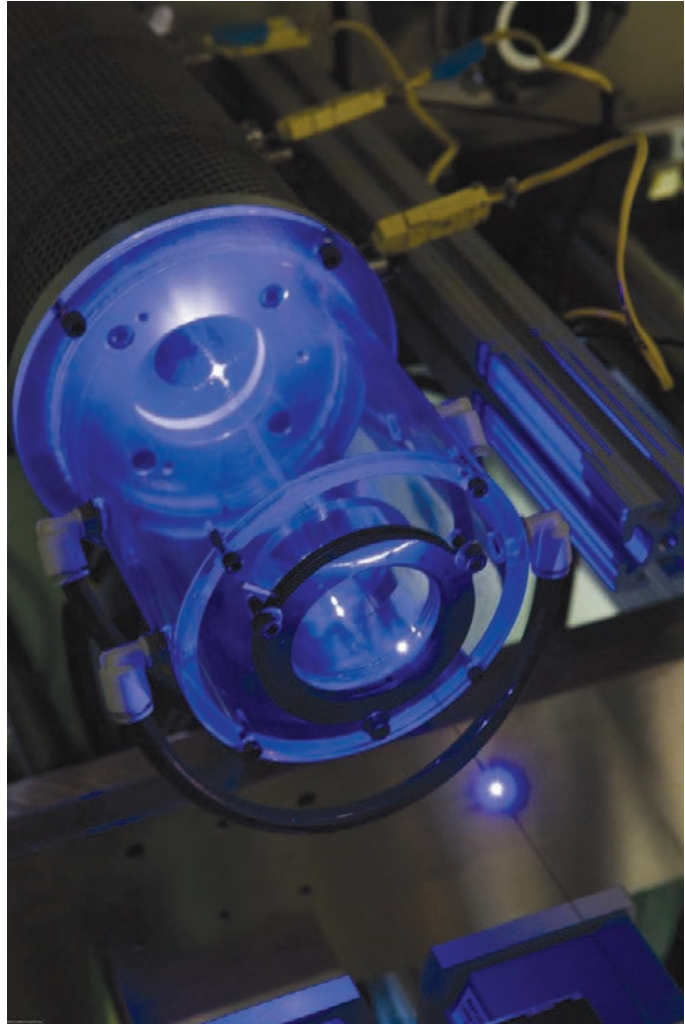

SWEET NEW THREADS

Semiconductors so small they are measured in microns are embedded into monofilament fibers by drawing the semiconductor, insulators and conductors at the same rate using AFFOA's draw towers.

Directorate. He is working on behalf of DOD's Manufacturing Technology Program to establish an advanced fibers and textiles manufacturing innovation ecosystem. He holds a B.S. in materials engineering from Drexel University and previously served in the U.S. Army, leaving service at the rank of major. He is a member of the AAC and a prior chair and current member of the American Welding Society D1.9 Structural Welding Titanium Code Committee. He has been awarded multiple patents and has been recognized by the Army's Greatest Invention Awards Program for inventions in titanium welding as well as armament and protection systems.

THE HYPERSONIC AND THE CAVE

The organic industrial base needs major upgrades if weapons facilities are to keep pace with modernization.

by Col. Stephen P. Dondero and Lt. Col. Dennis K. Williams II

In a recent meeting among numerous Army depot commanders, one asked the rhetorical question, “Would any of the services be comfortable storing a sensitive hypersonic missile system or any of its complex subcomponents in a wet cave?” The answer is obvious.

Weapons modernization is accelerating at a blistering—some might say hypersonic—pace to stay ahead of our potential adversaries. There is general agreement in defense circles that this drive is critical to success if our joint forces are to win in near-peer, large-scale combat operations.

Among these modernization advances are the hypersonic programs, directed energy weapons, long-range precision fires and upgrades to existing missile systems.

U.S. Army Futures Command has transformed the testing and acquisition process to field the next generation of weapons, but they are being developed faster than the sustainment planning for these systems. The Army must prepare the depots and arsenals within its organic industrial base to maintain, store and distribute these new and complex weapon systems in modernized facilities that are fit for the purpose. Though a great deal of effort has been made to maintain our strategic storage facilities over the decades, their average age is 70 years old. Many are more than 80 years old, having been designed and built in response to World War II. The need for major upgrades or even replacement is endemic.

We cannot modernize all of our facilities in five years—or even 20—because of numerous limiting factors such as funding, planning cycles, design timelines and competing defense priorities. We have to focus our efforts and start with what we call our strategic out-load locations, which are regional locations that can ship munitions globally at a moment’s notice.



THE MODERN LOOK

Modern storage magazines, which are larger, drier and provide electrical service, would provide greater capability to properly store modern munitions (Photos by Thomas W. Peske, Crane Army Ammunition Activity).

We must also keep a close eye on the second priority, our storage facilities. It is impractical for warfighters to carry all the munitions that they need in a conflict. There are seven geographic combatant commands across the globe, each with munitions requirements that Joint Munitions Command must meet. Both out-load and storage are key to maintaining munitions readiness. As Col. Gavin J. Gardner, commander of Joint Munitions Command, said in July, “We need modernized facilities and equipment to properly handle, store and distribute [munitions] at the speed of war.”

READINESS IS KEY

Readiness is among the top priorities across the services. The role of the organic industrial base is to support that priority. Readiness in the base can be measured by how quickly we can get to

the munitions, how fast they can be shipped and whether we can deliver serviceable munitions at the point of need without additional preparation. It is important to think about it in these terms, because some of our installations and activities have thousands of storage magazines—munitions storage facilities—of various types and numerous out-load platforms totaling over 20,000 acres.

For context, across the Joint Munitions Command—whose responsibility it is to execute the production, maintenance, storage, distribution and demilitarization (rendering inert) of America’s munitions—there are thousands of potentially explosive sites where these activities take place. Rail or road access to those sites can degrade over time, and some magazines’ doors and loading docks are aging. Some shipping facilities need upgrades to handle the net explosive weight (NEW) of surge shipments

Ready and reliable munitions equal readiness, lethality and victory in the physical battle domains.

because the facilities were designed, approved and built to handle lower-NEW shipments in an era with older equipment.

For those unfamiliar with the concept, net explosive weight is not the actual weight of the munition, but rather the total mass of the contained explosive substances minus all the packaging, casings, etc. If munitions are stored in magazines affected by water intrusion or pests, such as mice or bats, then quality suffers. Bat droppings corrode electronics, likely rendering the munitions unusable. Those items damaged by water or pests may not be suitable for immediate use by the warfighter, requiring costly and time-consuming refurbishment, repair or destruction of severely degraded munitions deemed beyond economic repair.

If a production facility is not approved for the net explosive weight it is needed to produce, yet another limiting factor is introduced to the equation.

The infrastructure that supports our munitions enterprise is equally as important to our military's readiness as the munitions themselves. Without serviceable ammunition at the point of need, our combat aircraft, main battle tanks and artillery systems are merely giant paperweights.

CLIMATE CONTROL NEEDED

Some of our emerging weapon systems are much larger and more sensitive than a basic 2,000-pound bomb. Therefore, the physical size and internal climate of our storage facilities are important concerns

to address. A touch of rust on a "dumb" munition may have little to no effect on its functionality, but it is unlikely to instill confidence in the airman or sailor loading it onto an aircraft's bomb rack. More importantly, a high-humidity environment may severely damage the sensitive electronics designed into many modern smart munitions, costing time, money and overall readiness.

What if magazines are too small, or cannot be accessed by special handling equipment, such as modern forklifts? We may find ourselves in possession of

expensive weapon systems without a suitable home. Imagine trying to move a 32-foot container full of sensitive electronics into a concrete, cavelike storage room with a concrete berm 10 feet in front of it. It would be physically impossible to maneuver the container through the door. And water intrusion—leaks or flooding—and bat droppings would seriously corrode the electronics, rendering them useless.

LEADING THE WAY

All of these factors and more must be taken into consideration in our modernization planning, prioritization and execution, preferably during development. Retrofitting existing facilities with temperature and humidity controls—either active, or more effective passive controls—will be critical to munitions readiness in most environments. Also key to modernization success, near and long term, will be demolishing old smaller magazines such



OLD SCHOOL

A black powder magazine, constructed in 1943, is limited in size, explosive storage capabilities, electrical services and environment controls.

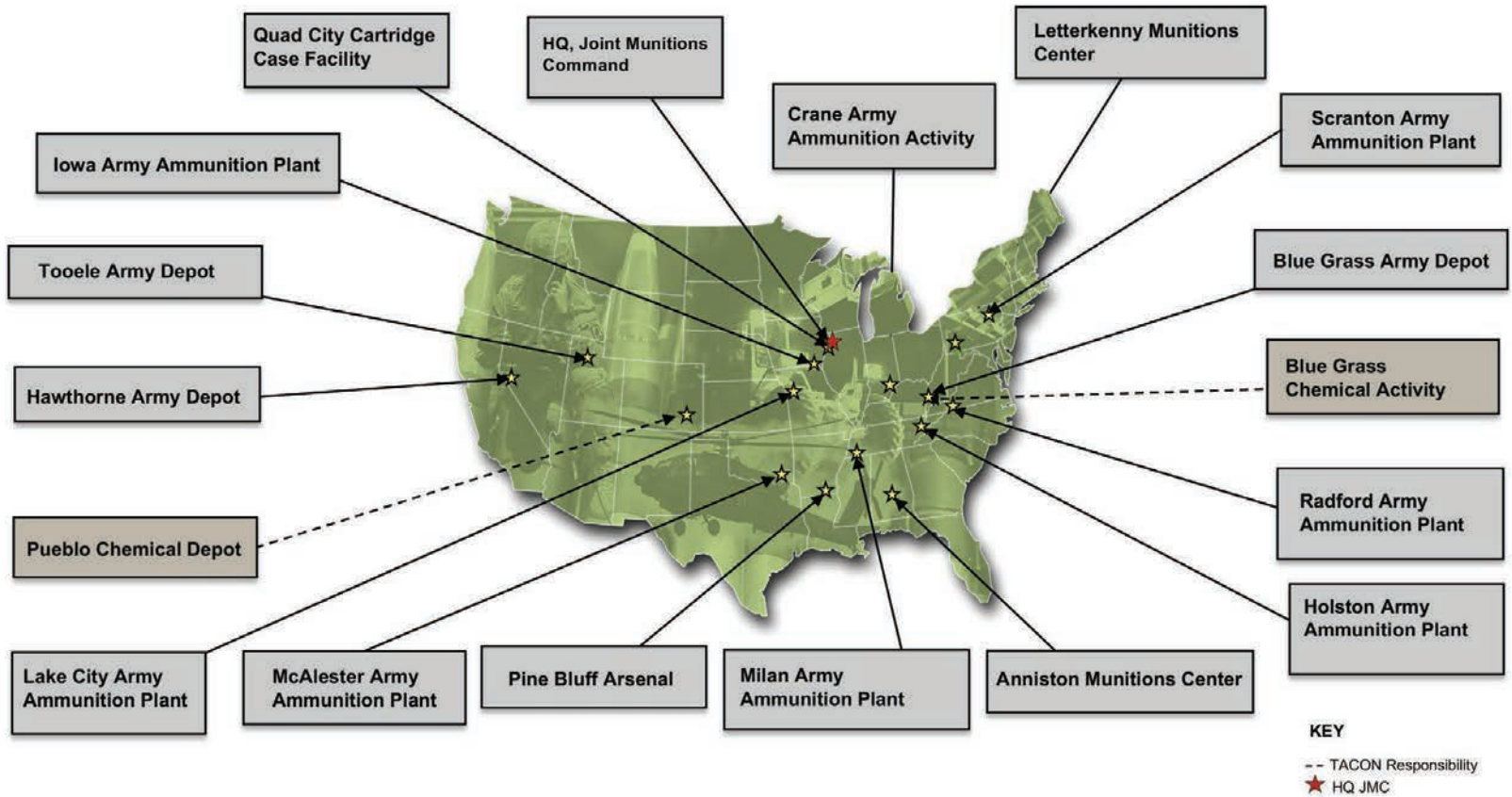

NATIONWIDE

Storage at regional locations across the nation allow munitions to be shipped globally at a moment’s notice. (Source: Joint Munitions Command)

as those for black powder, fuses and detonators, to free up real estate for modern storage and shipping complexes. Acknowledging that money will continue to be limited for the foreseeable future, we must develop a phased approach to modernize the munitions infrastructure across the depots and arsenals so that we maximize buying power.

KEEPING AN EYE ON ASSETS

With our aging infrastructure comes outdated storage, inventory and security protocols and procedures. We can improve markedly on those as follows:

To maximize available storage, we should switch from outdated two-dimensional square footage to three-dimensional, cubic-foot space management.

Currently, we are conducting costly and time-consuming in-person inventories. This certainly has a place in the modern world as a means to audit the accuracy of electronic systems, but it should not be the primary method in 2020. A more effective way to inventory and manage a large footprint containing tens of thousands of different items would be to use modern techniques such as artificial intelligence

(AI) and machine learning. We also could employ other commercial off-the-shelf solutions such as the latest radio frequency identification and smart tag technology, with automated sampling conducted by a small fleet or swarm of reader-equipped, autonomous or semiautonomous unmanned aerial vehicles (UAVs).

UAVs also could be an effective way to save time and money by reducing the number of security personnel needed to check every facility within a 24-hour period. Using AI and change detection technology—which detects changes in what should be there,

versus what is, or isn't, there—a fleet of UAVs with preprogrammed routes could perform required security checks while being monitored remotely by a smaller security workforce, and cover more ground in less time.

CONCLUSION

The first challenge facing our strategic munitions storage installations and facilities is ensuring that we have the ability to surge quickly, safely and effectively in order to out-load the munitions our joint forces need to fight and win.

Second, we must focus on our storage facilities and whether they can support larger, more complex munitions designed for the modern fight. Without serviceable munitions now, the speed of out-load is irrelevant.

Lastly, a modern approach to the space management, inventory and security of our munitions is necessary for the most effective overall management of our assets.

Working with the defense industrial base during development of the next generation of munitions will ensure that the organic industrial base understands future requirements. This approach allows the Army to

“We need modernized facilities and equipment to properly handle, store and distribute [munitions] at the speed of war.”



WASHOUT

A washed-out road at Crane Army Ammunition Activity limits magazine access by road crews.



WATER DAMAGE

Water intrusion in a high explosives earth covered magazine at Crane is one of the issues to be addressed with placing the next generation of munitions in older magazines.

make early decisions on where to invest in modernizing the base, rather than reacting to “what’s next.” In the process, we should look at commercial off-the-shelf solutions that optimize how we see space in 3D instead of 2D, improve accountability and ensure security.

We will have to invest wisely as we prepare to synchronize, prioritize and execute our modernization plans for the fiscal year 2023-2027 program objective memorandum and beyond. We must focus on those facilities where we store and distribute one of the most critical assets needed to deter and defeat our adversaries in the 21st century. Ready and reliable munitions equal readiness, lethality and victory in the physical battle domains. They also ensure that our most precious asset, our people, can accomplish their mission and come home.

For more information, contact Col. Stephen Dondero at stephen.p.dondero.mil@mail.mil or Lt. Col. Dennis Williams at dennis.k.williams8.mil@mail.mil. Or contact Joint Munitions Command at usarmy.ria.jmc.bmx.amsjm_pa@mail.mil or visit the JMC website at: <https://www.jmc.army.mil>.

The Army must prepare the depots and arsenals within its organic industrial base to maintain, store and distribute these new and complex weapon systems in modernized facilities that are fit for the purpose.

COL. STEPHEN P. DONDERO is the commander of Crane Army Ammunition Activity, Indiana, one of the organic industrial base’s largest munitions depots, with three subordinate depots. He is a career logistician with 25 years’ experience supporting American and Allied forces from the tactical to the strategic level. He has led Soldiers and civilians at the platoon, company, battalion and, currently, brigade levels. He holds a Master of Science Administration with a concentration in leadership from Central Michigan University, an M.A. in defense and strategic studies from the Naval War College and a B.A. in political science from Loyola University, Maryland.

LT. COL. DENNIS K. WILLIAMS II is the commander of Letterkenny Munitions Center, Pennsylvania, one of four strategic out-load sites among the organic industrial base’s munitions depots. He is a career logistician with 28 years of experience supporting American and Allied forces from the tactical to the operational level. He has led Soldiers and civilians at the platoon and company levels and, currently, the battalion level. He holds a Master of Management from the University of Phoenix, a B.S. in history from the University of Maryland, and a Demonstrated Master Logistician certificate from SOLE, the International Society of Logistics.

OUT WITH THE OLD, IN WITH THE NEW

An old, wood-core magazine door compared with a new, all-steel magazine door. Most munitions magazines were designed and built during World War II, and their building materials are degrading. Proper storage is one of the keys to maintaining munitions readiness.



MISSION CRITICAL

A brand name restriction may be necessary under certain circumstances, like a particular manufacturer's information technology that is an essential component of a certain system. (Images by Getty Images)



ON CONTRACTING

NOTHING TO SNEEZE AT

| What to know and what to avoid about brand name restrictions.

by Dennis P. Longo

The fourth article in the On Contracting series, based on the Competition in Army Contracting course developed by the author for the Office of the Deputy Assistant Secretary of the Army for Procurement.

I have allergies. For years I've had to sneeze into a handkerchief or wipe my nose at the most awkward moments. And when a handkerchief isn't available, I'd discreetly reach for a Kleenex, hoping that no one would discover my hideous disorder. It's embarrassing. And because of these face-leaking episodes, my having a Kleenex when a handkerchief isn't available is essential to maintain my personal dignity.

I realize that Kleenex is a commercial brand name product and I don't necessarily need a Kleenex brand tissue, I just need a tissue to relieve the face leak.

Which brings me to the real point of this article—understanding and articulating the government's procurement needs for commercial brand-name items or services.

"I need a Dumpster because it satisfies my agency's needs."

A commercial item is given a brand name to mark the item as being sold by its manufacturer to the general public. These brand names are usually easy to identify—such as Kleenex, Dumpster and Novocain.

When the government wants to buy a commercial item, does the government need that particular brand name item or simply need the function that the brand name item is designed to perform? Is the particular brand name item essential to the government's requirements, or can we modify a similar or generic commercial item to meet the government's requirement?

While commercial marketing may promote a product as a convincing solution to a certain need, the Federal Acquisition Regulation (FAR) requires the government to purchase the items and services it needs in a manner that will promote full and open competition.

THE EFFECT OF A BRAND NAME RESTRICTION

When the government restricts a purchase to a brand name item, or brand name-or-equal basis, it also restricts full and open competition. A brand name restriction eliminates full and open competition among all other manufacturers and suppliers of similar items or services. A restriction to full and open competition must first be authorized by documenting the sole-source action in a justification and approval (J&A), the document that authorizes, under certain conditions, contracting without providing for full and open competition.



THE KLEENEX PARADOX

Do you really need a Kleenex for your allergies, or can you survive with whatever tissue or handkerchief is handy? That's what the government wants to know during the acquisition process.

But why, you ask, does a purchase description for a brand name item, or brand name or equal, restrict competition when numerous suppliers of that brand name may be available to compete for the contract?

A purchase description that requires only Kleenex tissues, for example, effectively disqualifies all other tissue manufacturers from consideration. According to the FAR and the Defense FAR Supplement (DFARS), a brand name, or brand name-or-equal purchase description, restricts competition regardless of the number of sources solicited, and must be justified.

However, a brand name restriction may be necessary under certain circumstances. Information technology parts manufactured by a particular manufacturer, for example, may be essential components of a certain military system used in critical mission-related functions relating to both national defense and human safety. In this

example, the J&A must explain why the brand name information technology parts are “essential to the government’s requirements, and market research must indicate that no other companies’ similar products meet, or can be modified to meet, the government’s requirements.”

WHAT TO KNOW

A brand name description restricts competition typically because the government considers the brand name item or service to be available from only one responsible source and no other type of supplies or services will satisfy the government’s requirement—an exception to full and open competition allowed by FAR 6.302-1. All sole-source contracts awarded under this “one source” exception must be supported by an approved J&A.

The rationale for a brand name restriction that exceeds the \$250,000 simplified acquisition threshold must address two



CONSIDER THE OPTIONS

Is your chosen brand name item or service essential to the government’s requirements?



MAY THE BEST BRAND WIN

Even when deciding between two brand names, acquisition personnel need to produce proof that one brand is superior to the other through market research.

elements in a J&A, in addition to any mission-specific reasons to support the one source authority:

The brand name item or service must be “essential to the government’s requirements.”

Market research must indicate that other companies’ similar products do not meet or cannot be modified to meet the government’s requirements.

Element 1—Essential to the government’s requirements.

“Essential” means indispensable, or something that is critical to sustain the life of something. Brand name items may be critical, for example, to the operation of a certain military system to ensure human safety or the mission effectiveness of a system. The need to procure a brand name item or service that is essential to the government’s requirements eliminates all other commercial

items or services from consideration—even commercial alternatives that may perform the same function.

Explaining why the particular brand name item or service is essential to the government’s requirements is vital to support the brand name restriction in a J&A.

In April 2015, for example, the Navy’s request for quotations (RFQ) for brand name computer servers was challenged by a protest to the Government Accountability Office (GAO). The protester claimed that the request’s brand-name requirement improperly restricted competition.

The Navy’s J&A supporting the brand name restriction stated that the brand name computer servers were necessary because the servers were an integral component of the Navy’s submarine network and the use of the brand name components throughout that system was essential to the government’s requirements. Because

the servers were deemed mission-essential upgrades for the Navy's submarines, the justification effectively disqualified products manufactured by other companies.

The GAO denied the protest because the brand name servers were integral components of the Navy's network system used in critical submarine functions relating to both national defense and human safety and were necessary to achieve the highest possible reliability and effectiveness. See Core Systems, B-411060.

Element 2—Market research must indicate other companies' similar products do not meet, or cannot be modified to meet, the government's requirements.

Thorough and objective market research will help the government identify the capabilities and availability of commercial products or services that meet the government's needs. When the government intends to procure a brand name item or service, it must conduct market research to determine if other companies' similar products can meet its requirements. The market-research report must describe the extent and the results of the market research conducted. The research must have been meaningful.

According to FAR 10.001, agencies shall conduct market research to determine if commercial items or services meet or could be modified to meet the government's requirements. See FAR 10.001(a) (2) and (3). Failure to do so will invalidate a brand name restriction.

For example, in 2010 the Coast Guard restricted competition to authorized ITT Goulds Pumps repair facilities. The Coast Guard's J&A restricting the use of Goulds' brand name pumps and repair services stated that use of other than Goulds brand name parts could cause equipment

failure and render the patrol boats unable to complete mission requirements and possibly place the crew in danger.

A pump repair company that was not an authorized Goulds pump repair facility protested the Coast Guard's brand name restriction and demonstrated that it had successfully provided these pumps and services in the past. GAO subsequently overturned the brand name restriction because the Coast Guard had not presented any evidence of conducting market research to determine if commercial items or services meet or could be modified to meet the government's requirements. See Missouri Machinery & Engineering Company, B-403561.

When the government intends to restrict its needs to a particular a brand name item or service, by regulation it must conduct market research to accurately identify its needs and evaluate commercial items or services that may be available to meet those needs. Market research for a brand name restriction must be robust and

comprehensive to ensure the requirement is not unduly restrictive—that the brand name restriction is reasonably necessary to meet the government's needs. See also Land Shark Shredding, B-415785.

A brand name restriction also must be predicated on an evaluation of other similar products and of other companies' similar products that meet, or may be modified to meet, the government's needs and must be adequately documented in the J&A.

One agency's RFQ limiting competition to authorized resellers of brand name "AtHoc" licenses, upgrades and technical support for its mass warning and notification system was challenged by a protest to the GAO in 2013.

The J&A that approved the brand name restriction explained that the AtHoc system was already installed in the agency's infrastructure and in use by all its regions. The market research explained that the brand name restriction represents



CONSIDER THE COST

Purchasing brand name items or services without market research may waste government resources.



RESTRICTION NEEDS JUSTIFICATION

If a purchase is restricted to a particular brand name, or brand name-or-equal, it restricts full and open competition—and that needs a J&A documenting the sole-source action.

the best value, exceeds technical specifications, reduces training and provides quick alerts within the agency.

The GAO sustained the protest because the agency failed to document its market research of other vendors' similar products. Instead, the J&A stated that, based on market research, the purchase of the AtHoc brand name represented the best value solution because it exceeded technical specifications. See Desktop Alert, B-408196.

Finally, requiring the purchase of a brand name item or service without conducting market research not only violates acquisition regulations, but also may waste government resources.

In September 1990, for example, the General Accounting Office, as it was named then, reviewed a U.S. Army

Corps of Engineers \$3.3 million contract for upgrading electrical systems at Clear Air Force Station, Alaska. The General Accounting Office sought to determine whether the Corps' \$1.4 million brand name restriction for General Electric (GE) equipment included in that contract was proper.

The General Accounting Office review found that the Corps' actions were not in accordance with FAR market research requirements because it did not determine whether similar commercial products would meet its needs. Had the Corps competed the electrical equipment instead of requiring the GE brand name equipment, it might have saved over \$600,000 of the contract's total cost, according to the General Accounting Office. See Corps of Engineers Weak Contracting Practices.

CONCLUSION

A brand name, or brand name-or-equal, purchase description restricts full and open competition regardless of the number of sources solicited and must be justified. Although a brand name restriction may be necessary under certain circumstances, the particular brand name item or service must be essential to the government's requirements and fully supported by robust and comprehensive market research to ensure the requirement is not unduly restrictive of competition.

Additional information on Notice of a Proposed Contract Action and its impact on Competition in Contracting is available in the Training Library at: <https://spcs3.kc.army.mil/asaalt/procurement/SitePages/NewTraining.aspx>.

DENNIS P. LONGO is advocate for competition, task and delivery order ombudsman and senior procurement analyst at Army Contracting Command at Aberdeen Proving Ground, Maryland. A member of the Army Acquisition Corps, he holds a bachelor's degree from University of Baltimore and is Level III certified in contracting. His assignments include acquisition specialist at the Program Manager for Chemical Demilitarization within the U.S. Army Chemical Materials activity and procurement analyst at the U.S. Army Legal Services Agency. He served in the Army from 1971 to 1973 at the Southern European Task Force, Italy, and was deployed to Iraq as a civilian in 2003. He authored the Defense Acquisition University (DAU) Continuous Learning DOD Purchase Card tutorial in 2003 and DAU CON 160 Competition in Contracting course in 2020. He has been an instructor for competition in contracting since 2004. The first of the author's On Contracting articles appeared in the Winter 2020 edition of Army AL&T.

TARGET: RISK REDUCTION

JMC develops risk model to address vulnerabilities in munitions supply chain.

by Col. Gavin J. Gardner

Joint warfighters around the world depend upon a steady supply of ammunition. Understanding and maintaining the ammunition supply chain is especially complicated because of the wide array of components needed to produce bullets, bombs and other munitions. The U.S. Army Joint Munitions Command (JMC), in conjunction with governmental and private partners, is working aggressively to identify and mitigate vulnerabilities in the supply chain. To this end, JMC has developed a risk model, which, when incorporated with other data analysis tools, will ensure the maintenance of both ongoing production and surge capabilities, in service to the joint warfighter.

JMC's risk model is a more holistic way to view the ammunition supply chain and risk, based on information drawn from various data analysis tools. The risk model synthesizes existing supply chain information and includes metrics that highlight problem areas and measure progress. Effective use of this risk model requires the collection of information from a variety of sources.

An important source of information is the Industrial Base Assessment Tool, a web-based tool that provides supply chain management and decision-support information to enhance acquisition planning and industrial base preparedness. This tool documents the production capabilities, capacities, schedules, deficiencies and metrics of the ammunition supply chain. In particular, the database contains information for more than 1,300 components and 1,200 manufactured products used to produce ammunition. More than 300 U.S. government, and domestic and foreign commercial producers supply this information.

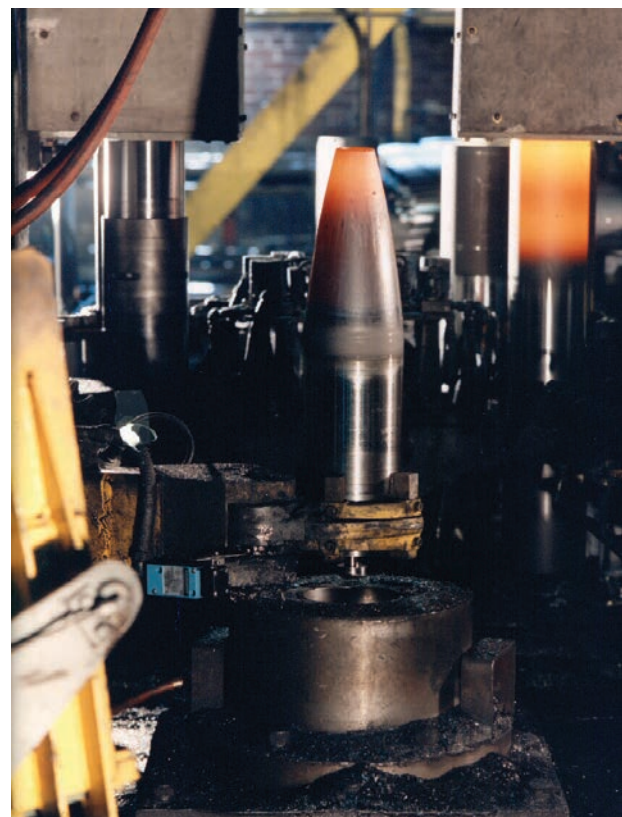

HOT OFF THE ASSEMBLY LINE

In the nosing process, shown here for large-caliber metal projectiles at Scranton Army Ammunition Plant in Pennsylvania, the open end of the cylindrical part is formed into the round tapered ogive, the curve of the forward section. The parts are glowing red from the forming process. (Photo by Dori Whipple, JMC)



BUILT FOR SURGE

Contractor employees at Iowa Army Ammunition Plant prepare 155 mm artillery rounds to be filled as a part of the load, assemble and pack operation. The plant is an example of surge production, a key consideration in JMC's risk model. The Iowa plant began production in 1941 to supply troops in World War II, then stopped in 1945 before resuming ammunition manufacturing in 1949, with a surge in 1950 in response to the Korean conflict. (Photo by JMC)

IDENTIFYING THE RISKS

Maintaining a consistent, unbroken chain of munitions requires accurate, up-to-date knowledge of sources of supply, production capabilities and the available stockpile. Acquiring this information requires close partnerships with the organic and commercial industrial base, as well as allied partners around the globe, each working to understand its capabilities and vulnerabilities at every step of the process. Using such information is critical for JMC to successfully manage the munitions enterprise while focusing particularly on supply issues, system resiliency and modernization planning.

The risk model helps analysts identify potential weak points that could develop into threats. Analysts then consider “what-if” scenarios to highlight potential disruptions to the industrial

base. This gives planners a better picture of challenges within the ammunition industrial base. Threats to the supply chain come in a variety of forms, including minimal availability of component materials, limited and evolving production capabilities, human interference and natural disasters.

Assembling and evaluating information about component materials is further complicated by the number of components that can go into a single item. Bomb, small-caliber and large-caliber ammunition currently rely on multiple components and chemicals from outside the United States. For example, the 30 mm ammunition, which is a relatively simple round by ammo standards, has a bill of materials that includes 35 unique components, made by 23 producers across 15 states and three foreign countries.

CHUTE FOR SHOOT

Lake City Army Ammunition Plant in Missouri produces 7.62 mm small-caliber munitions for the warfighter in support of global operations. Established in 1940, it is government-owned and contractor-operated. (Photo by JMC)

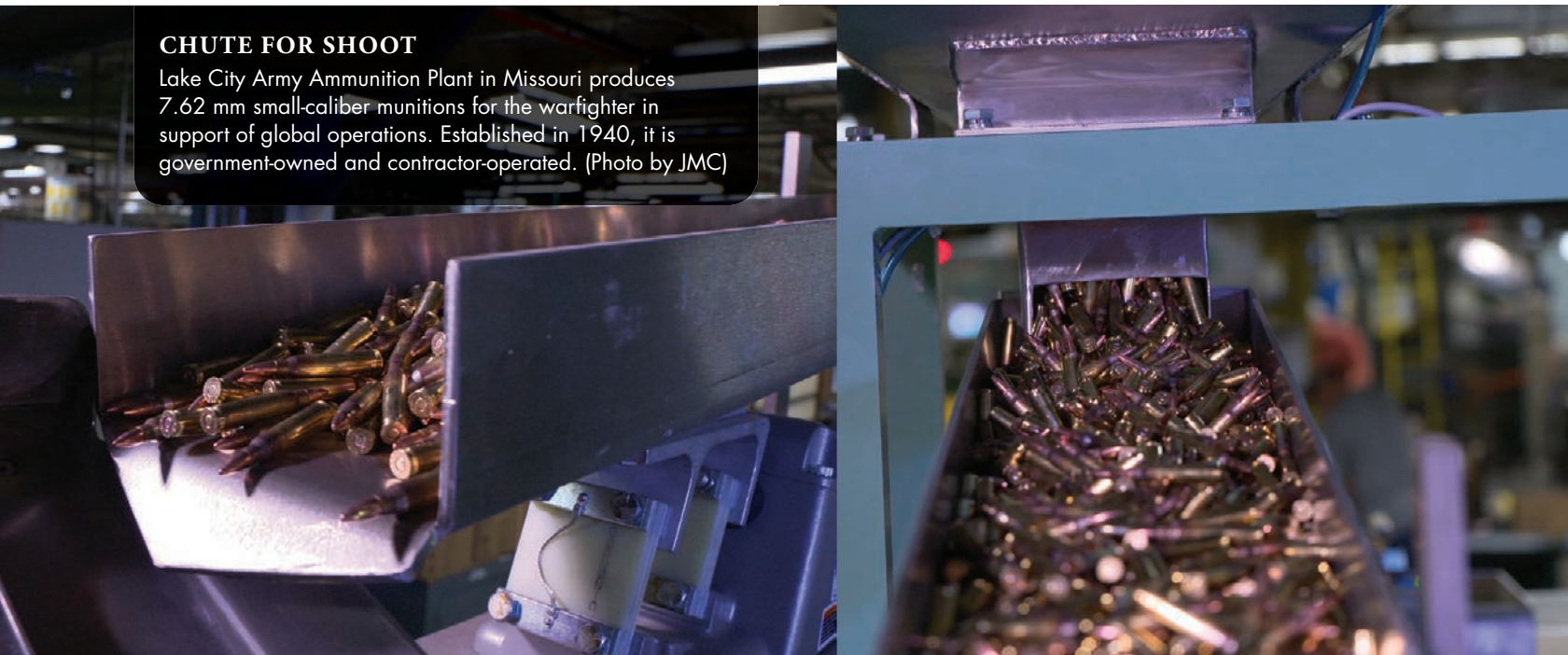

Depending on sources from outside the United States presents obvious security concerns. In addition to the standard transportation issues involved with importing components, an adversary might choose to interfere with the supply of materials or cut off the source completely. Limited availability of components would likely create further disruptions in the production stage.

JMC and its enterprise partners are investigating alternate sources of supply in an effort to mitigate risks to the supply chain and assess future workload needs. Ensuring ammunition readiness requires partnership between government and industry to address weaknesses in the ammunition supply chain. Potential solutions to address these concerns include developing a stockpile of components large enough to make up for potential shortfalls, or finding alternate sources for items that may be in short supply.

To this end, it is vital that contractors conduct full assessments of their industrial capabilities and their sources of supply. For example, there may be two manufacturers producing the same item, but if both manufacturers use raw materials that come from a single source, an upstream disruption to the supply of that component would impact both producers. Industrial partners must be aware of such vulnerabilities.

Likewise, where multiple layers of industry are involved, a primary contractor cannot assume that its subcontractors have multiple sources of supply, or that those supplies come only from the United States or its allies. Without comprehensive top-to-bottom knowledge of every level of the supply chain, potential vulnerabilities may not be evident.

Limited production capabilities can also negatively impact the supply chain. For example, if the production of an item relies on a single production facility, any disruption to production at that facility could create a critical break in the supply chain.

KEEP A BACKUP

Advancements in technology can create additional problems. Today's munitions use unique metal and polymer formulations machined with computerized equipment to improve functionality. Some of the greatest technology breakthroughs have been in electronics. For example, where there was once a mechanical fuze, there is now a fuze guidance system, requiring even more unique and technical components. Upgrades like improved circuitry not only add complexity in the production phase, they often require more specialized materials. All of this adds to supply chain requirements.



Counters to vulnerabilities in the manufacturing stage include maintaining redundant production facilities and, if necessary, modernizing existing facilities. It is critical that JMC and its partners move toward further modernization efforts.

Natural disasters can also have a devastating impact on supply lines. While these events are largely unpredictable, careful analysis using the risk model can help JMC prepare for such problems. Foresight, combined with flexibility when disasters do occur, can mitigate the impact. The emergence of the COVID-19 pandemic is an important case in point. Before the outbreak, JMC had already worked to develop an in-depth awareness of its supply chain. As global shutdowns occurred, JMC subject matter experts quickly worked with suppliers to mitigate risks to the supply chain.

Along with the ability to source components and produce material, a major concern for the ammunition industrial base is the ability to meet an uptick in requirements. There are several issues to consider when mitigating threats that work against a need for increased production. After-action reports from previous incidents when ammunition needs greatly increased provide leaders with lessons learned, allowing decision-makers to better understand

past needs. Current operational plans and “what-if” scenarios then enable leaders to anticipate future needs. It is critical for JMC and its partners to use such tools in order to accurately assess potential demand fluctuations, surge production given current equipment, the ability to hire workers to cover surge requirements, and the length of time required from time of contract award to time of delivery.

At each stage, contractors must be aware of their abilities and relate them to the current situation so that JMC and its partners can collaboratively anticipate and mitigate potential shortfalls. It is vital that both commercial and organic production facilities are communicating and are responsive to industrial-base inquiries regarding production-line layouts, shared production equipment and associated concerns. This will ensure that assessments use accurate data and correctly model the ammunition-production industrial base to enable the government to properly see itself.

CONCLUSION

Given the importance of safeguarding the munitions supply line for the joint warfighter, JMC maintains a stockpile of ammunition for use in the event of war or surge needs. Collectively, stockpiles of components and complete items ensure preparedness



LABEL AND LOAD

A contractor employee at Iowa Army Ammunition Plant labels a 155 mm artillery round as part of the load, assemble and pack operation. (Photo by Dori Whipple, JMC)

domestically and at global strategic theater locations. JMC continuously weighs its detailed knowledge of industrial base capabilities against the costs of establishing and sustaining strategic stockpiles of ammunition and components to ensure munitions readiness.

The successful delivery of munitions to the joint warfighter depends on cooperation among all partners within the ammunition industrial base. This partnership, in turn, requires effective communication not just between industry and government, but between industry and industry, ensuring that government, contractors and subcontractors understand one another’s vulnerabilities and capabilities as well as their own. Through active assessment and open communication, JMC and its partners can reduce reliance on foreign sources and mitigate potential threats to the munitions supply chain, meeting the needs of the joint warfighter by consistently providing lethality that wins.

For more information, visit www.jmc.army.mil.

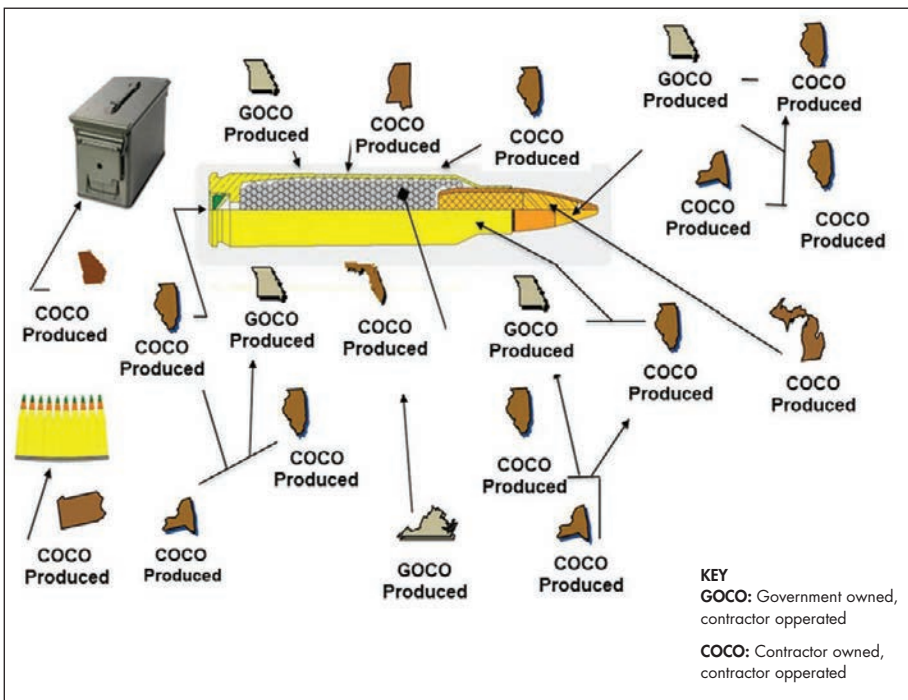

SUPPLY STRATEGY

Of the multiple parts that go into the cartridge of the 5.56 mm M855 Enhanced Performance Round (EPR), the vast majority are produced at more than one facility in the Army industrial base. The M855 EPR ammunition box is an item produced at only one facility. The graphic shows the type of facility—government-owned and contractor-operated or contractor-owned and -operated—and the state where it is located. (Graphic by JMC)

COL. GAVIN J. GARDNER assumed the duties of commander of the Joint Munitions Command and Joint Munitions and Lethality Life Cycle Management Command, headquartered at Rock Island Arsenal, Illinois, on June 11. He holds an M.S. in logistics management from the Florida Institute of Technology, M.A. in national security and strategic studies from the U.S. Naval War College and an M.S. in national resource strategy from the Eisenhower School for National Security. He earned a three-year Army ROTC scholarship and is a Distinguished Military Graduate from the University of Georgia with a Bachelor of Business Administration in production and operations management.

THE VISIBLE SUPPLY CHAIN

PM IVAS develops a dashboard to readily see its product supply line.

by Courtney E. Bacon

A BETTER VIEW

The IVAS Capability Set 2 Heads Up Display, shown here at the second Soldier touch-point event, held in November 2019 at Fort Pickett, Virginia, incorporates Microsoft HoloLens commercial technology to provide a tactical mixed-reality display that improves Soldiers' battlefield awareness. (Photo by Courtney E. Bacon, PM IVAS Public Affairs)



C OVID-19 has imposed chaos on industry supply chains around the world. The pandemic has curtailed people's ability to work in close proximity and assemble products in large facilities for transport by land, air or sea. It has sent demand soaring for personal protective equipment and package delivery of consumer goods. Both of these effects have been detrimental to the traditional operations of business markets, with significant delays in production and distribution.

The U.S. Army's modernization efforts require careful management of multitiered supply chains to synthesize products that are essential to maximizing Soldier lethality and ensuring an unparalleled advantage to the close combat fighting force. Disruptions to these supply chains can set back production timelines for modernization projects, potentially delaying the fielding of critical weapons and equipment to a deploying Soldier and squad.

In order to mitigate these compounding risks, the Army's Project Manager for Integrated Visual Augmentation System (PM IVAS) overlaid data on COVID-19 "hot spots"—areas where the rate of infection is rising—with the display of their tiered supply-chain tracker. The objective was to equip leaders with the best data possible to make optimal acquisition and fielding decisions for the project.

PM IVAS had already paved the way in Army acquisition best practices by applying rapid-prototype acquisition approaches to deliver a single platform for Soldiers to fight, rehearse and train.

EYES ON THE FUTURE

IVAS, assigned to the Program Executive Office (PEO) for Soldier, is adapting Microsoft's HoloLens commercial mixed-reality technology to develop a tactical goggle display complete with a conformal wearable battery, squad radio and integrated sensors that will increase a Soldier's battlefield awareness and ability to rapidly identify and engage potential threats.

The device integrates next-generation 24/7 situational awareness tools, including aided target recognition and squad performance metrics; high-resolution simulations that enable a portable synthetic training environment; and a networked cloud package for increased secure communications, ultimately delivering a suite of capabilities that improve Soldier sensing, decision-making, target acquisition and target engagement.

PM IVAS found success partnering with industry and other Army organizations, collectively making up "Team IVAS," to develop

and procure the highly specialized, integrated materiel solution. However, as COVID-19 emerged, international quarantine protocols impacted the global supply chain and had the potential to severely impact the project's delivery schedule.

Nicholas Pate, PM IVAS manufacturing engineer, and Daniel Maxwell, PM IVAS senior business intelligence analyst, were part of the team that was integral in leveraging the already



SEEING THE SUPPLY CHAIN

Full visibility of the supply chain has been a high priority for the PM IVAS team, in collaboration with industry partners. The security and quality of the composite IVAS system that Soldiers will receive depend on it. (Photo by Courtney E. Bacon, PM IVAS Public Affairs)

instituted Microsoft Power BI business intelligence software and elevating it to meet the evolving needs of the project during the pandemic. Pate explained the impact of the pandemic.

“The lockdown measures began just ahead of the scheduled opening of Microsoft’s IVAS manufacturing facility and start of the process of honing and refining the manufacturing procedures in preparation for IVAS early prototype production and then rapid-fielding production,” he said.

The pandemic threatened the success of the manufacturing facility, as the limited availability of resources and overall disruptions to the supply chain of subcomponent suppliers could have slowed or even prevented production.

A SENSE OF URGENCY

Fortunately, leaders understood the significance of the pandemic and its potential impact to the program.

“IVAS and PEO Soldier leadership recognized the urgent importance of monitoring how domestic and international vendors could be affected in their own localities and how the realities on the ground could potentially impact supply chain deliveries and, in turn, the IVAS schedule,” said Maxwell.

More importantly, leaders realized that the IVAS team had the capability to manage the risks in a more effective way than past traditional efforts.

“Our program’s aggressive schedule depends upon a global supply chain that is firing on all cylinders, and ‘black swan’ events like natural disasters and pandemics wreak havoc to such supply chains,” said Pate. “This most recent pandemic event has quickly brought the topic of

supply chain risk to the forefront of the program’s risk management efforts.”

DASHBOARD ON BOARD

Because the IVAS team initially understood the importance of this process from both product quality and security perspectives, it had already developed a dashboard to navigate the IVAS bill of materials that breaks down individual pieces of the composite system and tracks each component’s associated vendor on a global map.

Disruptive events are occurring more frequently. Therefore, stakeholders and customers must have redundancy and flexible mitigation plans in place.

“The overall dashboard allows our visibility into the tiered assemblies of an IVAS [unit], and how the lowest-level components are built into the highest-level device,” said Maxwell. “The bill of materials helps us build a great picture of our vendor map, while still only representing a small sliver of the truly expansive supply chain.”

Therefore, in response to the impending pandemic, PM IVAS data management and quality teams optimized their existing

dashboard capability and organized it to best view and manage potential COVID-19 supply chain implications as well.

“The team leveraged World Health Organization source data and began constructing the data model that merges it with the IVAS vendor list, creating a single heat map overlay of the two,” said Maxwell. “This creates a dashboard that highlights IVAS vendors in precise locations across the global map and reflects the most recent COVID-19 status at virtually any location.”

IVAS leaders refer to the overlay of data on coronavirus-positive areas with their supply chain as the “IVAS Supply Chain vs Black Swan Event” dashboard. This overlay allowed leaders and vendors to optimize information flow, exchange information across tiers and identify pandemic-related disruptions throughout the tiered chain so that minor obstacles and bottlenecks could be addressed before they had the potential to cause major disruptions.

“The objective is to allow stakeholders the ability to plan and manage the program with full visibility of the supply chain, including the sole, limited source and long-lead items as well as key raw materials,” said Pate. “In reality, each item has its own unique supply chain consisting of numerous steps for manufacturing, assembly, calibration, test, packaging, transport and warehousing. So the dashboard has been an effective tool for allowing leadership to better understand where potential problems lie so that appropriate actions can be taken to keep the program on track.”

The IVAS team has developed this solution to enable the project’s supply chain visibility. The goal of increased transparency is to enable the accurate communication of data and streamline monitoring processes



THE SUM OF MANY PARTS

Capability Set 3 of IVAS, the military form factor prototype, is set to be tested during the third Soldier touch-point event at Fort Pickett, Virginia, in October and November. To get to this point despite the coronavirus pandemic required PM IVAS and PEO Soldier leaders to understand how the lockdowns affected the supply chain for domestic and international vendors and, in turn, the IVAS production schedule. (Image by Microsoft Corp.)

to best support informed, data-based acquisition and fielding decisions. These solutions are valuable to both military programs and private vendors because of the high cost of supply chain losses as well as the real-world implications to the warfighter of a product delay.

“The dashboard allows our visibility into the tiered assemblies of an IVAS [unit], and how the lowest-level components are built into the highest-level device.”

“It is a big deal right now, considering the massive realignment of global supply chains as a result of recent events such as COVID-19, international trade disputes and new laws for foreign-owned businesses,” said Pate.

NO WEAK LINKS

Disruptive events are occurring more frequently. Therefore, stakeholders and customers must have redundancy and flexible mitigation plans in place.

“This is not the first time, nor will it be the last time, that a program encounters a black swan event that wreaks havoc with the schedule due to impacts on the supply chain,” said Pate.

Mark Stephens, PM IVAS director of acquisition and operations, led the team that prioritized supply chain visibility and security, and explained the critical need for supply chain visibility solutions across the board.

Leaders realized that the IVAS team had the capability to manage the risks in a more effective way than past traditional efforts.

“Organizations need better tools for quickly assessing the impact and reacting to black swan events. A [supply chain visibility] solution will enable entirely new risk mitigation strategies to ensure business continuity in spite of such occurrences.”

Although preparation and forward thinking can streamline supply chain logistics, the problem is complex. “Currently there is no enterprise-wide supply tracking system, as each vendor has individualized methods of monitoring their production, with data housed in different departments and locations, and with various requirements for database communication. This causes information to be stovepiped and fragmented, leading to inaccurate delivery projections,” Stephens added.

Stovepiped information is problematic, especially because supply chain disruptions can have real-world impacts to the Soldier and squad. At a program level, supply chain visibility provides oversight to end-product fielding timelines that impact military readiness across the enterprise.

For supply chain visibility to work, there must be trust and collaboration between the company and its customer, as the solution hinges on the ability to partner with vendors to track supply movement. While for some, the transparency component may sound daunting, the benefits are numerous.

“An end-to-end [supply chain visibility] solution aims to reduce supply chain risks,

improve lead times and identify problems in product security, quality and shortage along the chain,” Pate said. “The visibility allows for improved lead times, more evenly distributed sourcing and risks, more efficient shipping routes, better understanding of diminishing manufacturing sources and materiel shortages and a better understanding of security and quality risks.”

Stephens contrasted the projected improvements of enterprise-wide supply chain visibility with current contracting processes.

“Our vision is that this enterprise-wide [supply chain visibility] monitoring system initiative is the next revolution of program management in predicting [the] probability of successful project delivery. Even with firm fixed-price contracts, if the manufacturer misses delivery dates, the impact is felt by a waiting unit commander,” he said.

The ideal end state of the dashboard will allow the tracking of component movements across the supply chain, ultimately ensuring minimal impact to the project and warfighter.

“A comprehensive [supply chain visibility] solution gives program managers the ability to better forecast production and delivery schedules, prioritize risks and implement alternate sources of supply or contingency plans to ensure equipment can be fielded as planned,” said Stephens. “For fielded systems, [supply chain visibility] will provide unit commanders the

ability to better estimate the material availability and readiness for mission tasking and training exercises.”

CONCLUSION

The IVAS team, strengthened by its collaboration between government and industry partners, initially prioritized supply chain visibility efforts to ensure the security and quality of the composite system. The supply chain visibility solution postured the team for maximum flexibility, which allowed them to better manage both the direct and indirect impacts of COVID-19 to the full scope of the project.

According to Maxwell, “In other words, we are currently tracking ‘what’ is being built, but our goal is to expand into ‘how’ it is built by tackling [supply chain visibility].”

For more information, contact PM IVAS public affairs specialist Courtney Bacon at courtney.e.bacon.ctr@mail.mil or visit the PEO Soldier website at <https://www.peosoldier.army.mil/>.

COURTNEY E. BACON is a public affairs specialist providing contract support to PEO Soldier’s PM IVAS on behalf of TMGL LLC. She has a B.S. in biology from George Mason University and is working toward a master’s degree in biodefense and international security from George Mason’s Schar School of Policy and Government. She previously worked in communications and public affairs for the Defense Information Systems Agency.

INDUSTRIAL STRENGTH

A large military helicopter, likely an Apache, is shown in flight over a desert landscape. The helicopter is viewed from a low angle, showing its rotor blades and various armaments. A missile is being fired from the helicopter, with a bright flame and smoke trail visible. The background consists of a vast, arid desert with sparse vegetation and distant mountains under a clear sky.

FLIGHT TEST

The JAGM missile was tested at Yuma Proving Ground, Arizona, before the project moved into low-rate initial production. (Photos by U.S. Army)



Missile-seeker components illustrate how the Army works with industry to develop unique or exotic materials to fill capability gaps.

by Argie R. Sarantinos

The U.S. Army Combat Capabilities Development Command's (CCDC) partnerships with industry are essential to success as it continues to solve some of the Army's most complex problems by transforming critical technology into capabilities. These collaborative partnerships not only drive CCDC's science and technology efforts, they also enable the command to provide Soldiers with the best technology for the future fight.

CCDC, a major subordinate command of the U.S. Army Futures Command, maintains a steady stream of world-class technology through its partnerships with other government organizations, academia and industry. With six research and development centers, an Army research laboratory and a data-analysis center, the command works with hundreds of nontraditional defense companies and industry to strengthen its extensive technology portfolio. CCDC also has three regionally aligned international elements, the CCDC – Americas, – Atlantic and – Pacific centers. Through its partnerships, CCDC develops, integrates and delivers technology to support multidomain operations by 2028, while maintaining a balance of scientific research for technology that may not be developed until 2050 or beyond.

The command collaborates with industry by using traditional contracting methods, cooperative research and development agreements, and a number of different collaborative consortiums, including the Defense Ordnance Technology Consortium and the Aviation and Missile Technology Consortium. CCDC also works closely with small businesses by communicating its strategic direction and investing in emerging commercial technologies.

Beginning in 2017, CCDC partnered with industry to develop an affordable manufacturing solution for complex missile-seeker components that will be used on attack helicopters, including the AH-64 Apache and Future Vertical Lift systems. A missile seeker, which is the front part of a missile, senses heat, light or radio waves that keep the missile on target. A missile-seeker component is part of the missile seeker and includes the window, optics, sensors and other electronics. The seekers provide additional capability and enable missiles to precisely hit targets in the anti-access and area-denial environment

by using different modes, allowing the missile to switch between optical and radio-frequency guidance that greatly increases the ability of the missile to stay on target. This project strengthened the industrial base and mitigated production delays of the missiles, enabling the Joint Air-to-Ground (JAGM) program to meet its low-rate initial production schedule.

The project was spearheaded by the U.S. Army Manufacturing Technology (ManTech) program, which CCDC manages on behalf of the deputy assistant secretary of the Army for research and technology, who has overall responsibility for the Army's program. ManTech supports Army readiness and modernization priorities by improving and maturing manufacturing capacity and capabilities. Managers at CCDC centers and labs coordinate efforts by tracking advanced manufacturing science and technology topics of interest in support of their laboratories and acquisition partners. The managers work with science and technology, program executive office and cross-functional team stakeholders to prioritize the best manufacturing technology projects for the Army, including the complex missile-seeker components project.

SEARCH FOR SOLUTIONS

One of the Army's challenges is finding companies in the defense industrial base that have the expertise or production capability to make items or produce the prototypes that scientists and engineers develop in laboratories. ManTech funds projects to mature high-risk, high-payoff manufacturing processes that strengthen U.S. industry and provide more affordable weapon system components for the Army. The ManTech team also works closely with the Army's organic industrial base, which includes



TRIPLE THREAT

A copper-graphite-metal composite is one of the main materials used in JAGM missile seekers. The composite has unique thermal properties for heat removal.

depots, arsenals and ammunition plants, to provide these manufacturing solutions.

The ManTech program invested in improved manufacturing processes for boron carbide, which is used in body armor plates. Body armor plates use a combination of elements in a metal-like matrix that improves performance by providing an extremely hard material to protect Soldiers. ManTech invested in an improved manufacturing process for boron carbide and functionally equivalent silicon carbide in the 1990s, which enabled initial production of the Interceptor Multi-Threat Body Armor system. The armor was used by the armed forces during the 2000s, with limited usage into the mid-2010s.

In response to the need for more affordable manufacturing solutions for complex missile-seeker components, ManTech selected two manufacturing improvement projects, one for a complex material and one for lenses. These efforts kicked off in the 2017 fiscal year and concluded in the 2019 and 2020 fiscal years, respectively.

A main material used in JAGM missile seekers is a copper-graphite-metal composite (trade name Cu-MetGraf), which is a unique material that dissipates heat, allowing the missile seeker to function properly. Effectively removing heat from sensitive electronic devices attached to circuit boards is critical for high-performing JAGM seeker assemblies. Making the material for this application is unique and specialized. When the Army required JAGM production to ramp up, Parker Hannifin's Advanced Products Business Unit in North Haven, Connecticut, partnered with the National Center for Defense Manufacturing and Machining (NCDMM) to transition from a low-volume, pilot-scale operation to a full-rate production environment. Improvements to yields, cycle time and capacity were needed in order to effectively strengthen the copper-graphite manufacturing for long term supply chain sustainability.

One of the key improvements focused on automating the melting and handling of molten copper, which is used to make Cu-MetGraf. NCDMM was instrumental to bringing industry best practices and new ideas to this project because it offers technical expertise and access to a vast alliance network of other companies.

ManTech's partnership with NCDMM began in 2003. NCDMM established a strong connection between acquisition program needs and science and technology solutions from the beginning of this partnership and facilitated implementation



LOAD IT UP

A JAGM missile is loaded onto an AH-64 Apache attack helicopter during the JAGM initial operational test and evaluation. The test was conducted at Eglin Air Force Base, Florida.

of ManTech-funded projects within the industrial base that ultimately affected Soldier warfighting capabilities. NCDMM has increased its portfolio since its inception with a variety of collaboration and partnerships across DOD. NCDMM, which is a not-for-profit company, proactively engages with all branches of the U.S. military and its industrial base to control cost and improve productivity and performance of manufactured parts and assemblies. The company strengthens the U.S. industrial base by connecting manufacturing companies across the country. Recently, NCDMM was selected to lead America Makes, the Manufacturing USA Institute for additive manufacturing.

CUSTOMIZING PROCESSES

Lenses are used in guided missiles to change the direction of the light rays to enable missiles to see their targets. Scratched or warped lenses alter the laser line of sight, which may disrupt the

missiles' mission. The ManTech team partnered with industry on the missile seeker project by implementing custom tooling and an automated process.

Before the new process, lenses were often damaged and ultimately scrapped during the grinding and polishing process. The team implemented a customized machine with a vacuum tool to pick up the lenses without damaging or dropping them. The new process reduced the number of steps the operators needed to perform and enabled operators to measure components without worrying about alignment issues. The new process is also much more efficient and repeatable, and is easier for new operators to learn.

The project drastically reduced the processing time for lens assembly from seven days to approximately one and a half hours and improved safety by automating the transfer and pouring of molten

copper. Automating the process not only controlled the copper transfer and pour time, it also improved repeatability of the process. NCDMM was also instrumental in this project—for example, the team discovered that adding bumps to the bottom of the lens allowed the epoxy to evenly disperse without impacting the function of the lens. Without this partnership, a great idea may have been missed and the project may not have been as successful.

CONCLUSION

NCDMM's role through the years has ranged from project integration to project execution of Army ManTech projects. They have used a variety of contracting methods, including traditional contracting, cooperative agreements and other-transaction authorities. Through America Makes, NCDMM also participates in developing technology road maps and informing strategic planning for critical topics, including additive manufacturing.

CCDC's relationships with industry partners around the world enable the command to discover new and different manufacturing processes that are critical to developing technology for Soldiers. These technologies are the foundation for the battlefield of the future, supporting the Army's modernization priorities and giving Soldiers the tools they need to fight and win.

ARGIE R. SARANTINOS, a public affairs specialist for Huntington Ingalls Industries – Technical Solutions Division, provides contract support to CCDC. She holds an M.S. in professional writing and a B.A. in mass communications from Towson University. She has 14 years of public affairs experience supporting DOD.

GFEBs FINDS ITS SEA LEGS

Teaming with industry, the Army is helping the Navy adopt its General Fund Enterprise Business System.

by Paul “Pablo” McKellips

Mention the word legacy in a military setting and images of Chesty Puller, Colin Powell and Chester Nimitz come to mind. There is the legacy of Michael Jordan in basketball, Jim Brown in football, Mia Hamm in soccer and Babe Ruth in baseball.

Legacy.

But add one word to the end of legacy, and a “Field of Dreams” quickly morphs into a swamp of nightmares.

Legacy *systems*.

SPECIFICALLY, FINANCIAL SYSTEMS

With more than 35,000 current users, the U.S. Army has replaced upward of 80 legacy systems for 37 different organizations in 71 countries with its comprehensive solution, General Fund Enterprise Business System (GFEBs). GFEBs is an enterprise-resource planning solution that integrates financial, cost and performance data across the Army and beyond. The software system captures and records financial transactions on a single, worldwide platform, eliminating the need for data reentry. Built on SAP commercial off-the-shelf software, GFEBs complies with statutory and regulatory requirements for funds control and accounting, providing real-time visibility that improves financial decision-making.

The GFEBs implementation is designed to standardize business processes by replacing or subsuming legacy accounting and asset management systems to maximize the potential for a successful financial statement audit. GFEBs allows the Army to track and audit each business event to ensure proper financial accountability.



LEARNED DISTANCE

Comptroller Lt. Carla Santiago of the Naval Health Clinic Annapolis and Deputy Comptroller John Day discuss the GFEBs platform while maintaining the recommended social distance outside the clinic. (Photo by the author)

Fully fielded in 2012, GFEBS improves internal controls by providing full cost reporting of the various operating agencies for the proper use and control of their budgets. In addition, GFEBS accommodates emerging requirements, including improved funds balance with the U.S. Treasury. It has simplified processes of the financial community by sunsetting legacy systems, and has improved integration of financial data across DOD. GFEBS is a project management office within the Program Executive Office for Enterprise Information Systems (PEO EIS).

WELCOME ABOARD, NAVY

With the Army's transition to GFEBS now complete, it was time to bring the Navy on board. In late 2018, Vice Adm. C. Forrest Faison III, the Navy surgeon general, mandated that Navy Medicine transition from its Standard Accounting and Reporting System – Field Level (STARS-FL), a “noncompliant legacy accounting system,” to GFEBS.

The Defense Health Agency had the mission to consolidate all military health systems into one systemwide accounting solution so as to meet the requirements for financial auditability and comply with other DOD initiatives and reporting requirements.

The Navy's Bureau of Medicine and Surgery (BUMED) and the Army's GFEBS portfolio managers quickly forged a strategic alliance to navigate away from STARS-FL and over to the GFEBS platform.

“Our original schedule took us out to the summer of 2021,” said Maj. Lloyd Alaimalo, the assistant product manager of GFEBS who serves as the project lead for BUMED. “Once underway, the mission objective was accelerated to complete the



SAFE HARBOR FOR SAILORS

The Naval Health Clinic Annapolis, which went live on the GFEBS platform on Jan. 1, 2020, provides medical services to the United States Naval Academy as well as active-duty Sailors and their families in the area. (Photo by the author)

transition to GFEBS prior to the start of the government's fiscal year 2021.”

Navy BUMED has an enormous global footprint, loaded with geographic and logistical challenges. Throw in an accelerated timeline—then amplify that with a global pandemic—and software conversion becomes a much harder pill to swallow, even for Navy Medicine.

MAKING WAVES

IBM's Federal Government Sector team offered an innovative solution as an industry partner to the GFEBS program. The BUMED deployment was broken down into four geographical waves, starting on

the East Coast of the United States in Wave 1, and moving incrementally across the globe. The BUMED conversion to GFEBS would take place in multiple waves, ultimately fielding to more than 1,100 users at 36 separate military treatment facilities.

According to Tom Kennedy, BUMED project manager on the IBM Army GFEBS program, IBM's key role was to lead the organizational change management to make the transition a success. “Our mission was to transition BUMED from STARS-FL to GFEBS on schedule, giving them the knowledge and skills necessary to perform their daily duties.”

Moving Navy BUMED from legacy systems to GFEBs was not a “light switch” event. The Army deployed roadshow teams comprising five IBM staffers; Alaimalo as the GFEBs project lead; representatives from the functional organization, the Office of the Assistant Secretary of Defense for Health Affairs; and a BUMED transition team of experts familiar with both the old Navy system and the new Army platform.

A comprehensive team of stakeholders is part of every GFEBs implementation.

Scott Wardell is director for Health Affairs, the proponent organization for the BUMED deployment of GFEBs. Wardell oversaw a team of experts who assisted in the coordination of the roadshow development. Health Affairs bridged the gap between “as is” and “to be.”

“The roadshow team has their boots on the ground and visits each site,” said Alaimalo. “It’s an important part of the deployment where end users can meet with the folks who have the subject matter expertise. All stakeholders—IBM, Health Affairs, GFEBs and the BUMED transition team—all have a piece of it and own the success.”

“It was like a whole new language,” said John Day, deputy comptroller for Naval Health Clinic Annapolis. “It helped having people there who spoke both languages—Navy and Army—so that we could better understand the language we were learning.” The roadshows included training, transactional simulations and role-playing to define the various user roles. “The training was very good,” said Day. “It wasn’t like typical military training where you have to click through slides. You actually had to pay attention and do some transactions.”

GETTING TO GREEN

There are many different user roles within GFEBs. Data entry, inventory, cost management, reconciliation and analysis are just a few. To bridge the language gap between Army and Navy, roadshows focused on identifying how each person at the Navy’s military treatment facilities would use GFEBs to perform their daily duties. “We gave out initial role

assignments and quickly realized we gave some people too much access—others not enough—and had to dial that back a bit,” said Day.

Every role assigned during the roadshow incorporates associated training that must be completed by the user before accessing GFEBs. “We monitor the metrics of these users as they prepare for GFEBs,”

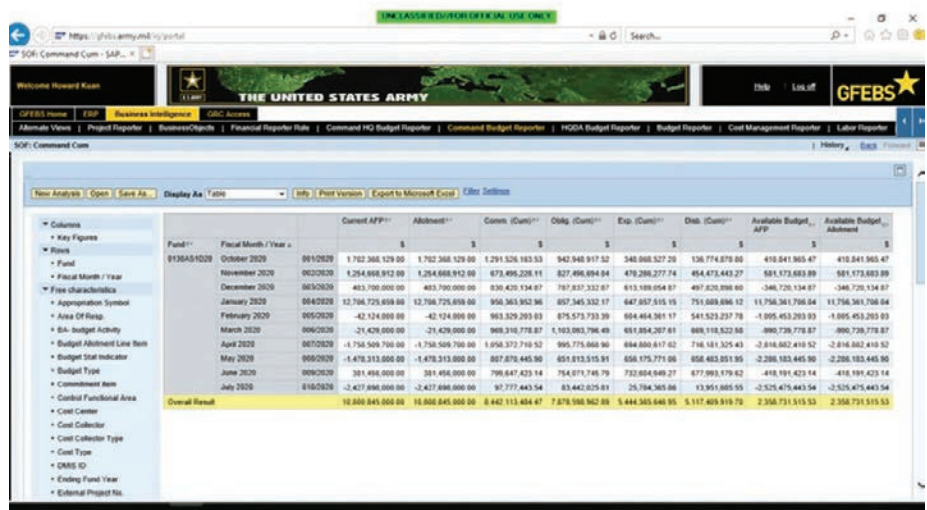
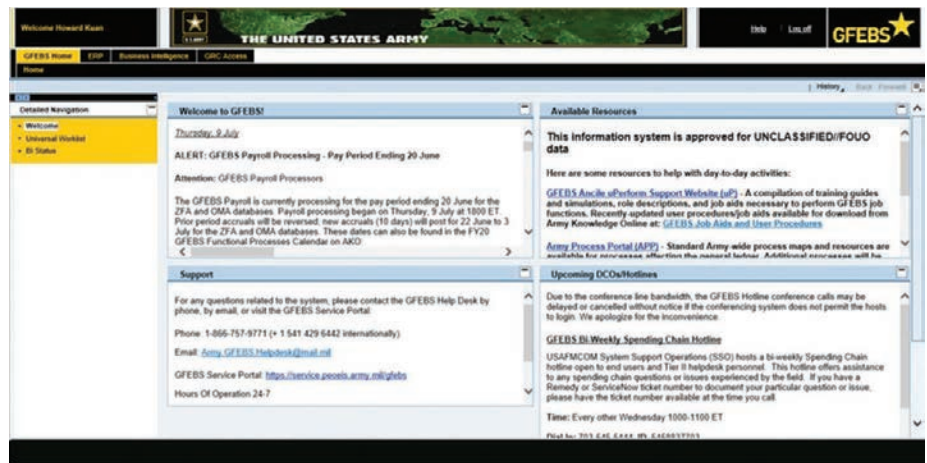

A LOOK INSIDE

The GFEBs software captures and records financial transactions on a single, worldwide platform, eliminating the need for data reentry. It is built on SAP commercial off-the-shelf software, and complies with statutory and regulatory requirements for funds control and accounting. (Image courtesy of PEO EIS)



**DASA Financial Information Management (FIM)
Functional Integration Division**

- Requirements collection & adjudication.
- Subject matter expertise.



**Health Affairs Functional Champion (HAFC)
GFEBs Implementation Support**

- MHS implementation lead.
- Requirements definition.
- Subject matter expertise.



**GFEBs Program Management Office (PMO)
Development & Modernization**

- System integrator acquisition.
- System integrator oversight.
- System integrator (IBM).
- Deployment & change management.



**Financial Management Command System
Support Operations (SSO)**

- Business process & system subject matter expertise.
- Training.
- System sustainment.

THE CREW

The Office of the Deputy Assistant Secretary of the Army for Financial Information Management, the Health Affairs Functional Champion and the U.S. Army Financial Management Command’s Systems Support Operations each provided support to the GFEBs transition effort. (Image by PEO EIS)

said Alaimalo. “We review these numbers with the customer every week. A week from ‘go live,’ we have a ‘go/no-go’ decision meeting with all stakeholders. We produce the latest metrics, and senior leaders vote on whether a site is ready to go live or not. Our mission is to always get to green.”

“Health Affairs worked closely with the Army on change management, communications and training activities,” said Wardell. “With our most recent wave, we became the only organization to have 100 percent of all users trained prior to go-live.”

WEATHERING COVID-19

Naval Health Clinic Annapolis, which was part of Wave 1, went live on the GFEBs platform on Jan. 1, 2020. “Our over-the-shoulder support was scheduled to end after 90 days, around the beginning of April,” recounted Day. “COVID pulled them out of here sooner than planned. Being able to pick up the phone and have a question answered was still a great benefit, but just not the same as having an expert sitting outside my office.”

“We had to exercise flexibility to respond rapidly to COVID-19 challenges faced by military treatment facilities throughout the world,” said IBM’s Kennedy. “Moving from an on-site, in-person user support strategy to a virtual approach for both roadshow and over-the-shoulder support was a significant undertaking in both planning and execution. There was no interruption to the support provided to Navy facilities, and it has proven to be an effective approach to deploy GFEBs.”

Wave 2 began on May 1 and stretched from the Charleston, South Carolina, military treatment facility to the one at Great Lakes, Illinois, from Corpus Christi, Texas, to Navy Medicine West in San Diego. It encompassed 13 more sites and more than 380 additional users. Wave 3 received the go-live decision on time in late June, adding 11 sites and more than 340 users to GFEBs.

AUDITABILITY SEA CHANGE

In the world of military finance and accounting, auditability is the GFEBs game changer. Perhaps the greatest benefit of GFEBs



WAVE ON WAVE

GFEBs was deployed to Navy Medicine in geographic waves, beginning with facilities throughout the eastern U.S. and ending with locations on the West Coast and outside the continental U.S. (Image by PEO EIS)

is the audit trail and traceability. Every transaction is recorded and available instantly with complete transparency.

“Auditability is really the byproduct of accountability,” said Jonathan Moak, the senior official performing the duties of the assistant secretary of the Army for financial management and comptroller. “GFEBs was designed to deliver functionality that enhances accountability through increased transparency. Improving the efficiency and oversight of business processes is what will ultimately put you on the path to a successful audit. With that in mind, it’s important that we, the Army, continue

to share systems that encourage good business practices that benefit our service members and fulfill our obligations to the American taxpayer.”

The Navy agrees that through GFEBs, accountability has increased dramatically. Day explained the power of real-time visibility. “GFEBs is much more robust than what we were used to,” he noted. “You can go through and see the transactions. You can see who did what. The greatest impact is to your financial statements and your auditability. If I want to look up something, I can go into GFEBs and find the information quickly.”

As an example, Day elaborated on the process to track pharmacy orders. “In STARS-FL, I could probably go back, but I would need to pull in other people and other systems to see where pharmacy placed an order. Now, in the single GFEBS system, you can see exactly how much aspirin was ordered, how much it cost, who placed the order and when it was delivered.”

LESSONS LEARNED

GFEBS changes and simplifies business processes for Navy Medicine, from payroll to the way goods and services are procured subject to a real-time check of available funds. BUMED is now in full compliance with congressional and DOD requirements, and it meets the critical milestones for financial statement auditability. As with all organizations on the GFEBS platform, senior leaders can now focus on critical analysis instead of data entry and reconciliation.

“Collaboration between the numerous organizations involved with the deployment has been critical to the successful fielding of GFEBS,” said Wardell. “The Health Affairs-led stakeholder council brought senior leaders from all organizations together monthly to review progress, challenges and solutions.” In addition, weekly deployment meetings and system focus groups prepared other stakeholders and educated the BUMED community. But as with any major change, there have been a few challenges along the way.

“Was the GFEBS changeover smooth for Navy Medicine? Yes and no,” said Day. “The soft launch was good because at the time, we had minimal funds until the third quarter,” which meant there were only a few options for documents to be processed. “It was nice to be dealing with a small universe of a few documents in case we had issues. But we felt that we were



ON THE ROAD AGAIN

Sailors and civilians assigned to Naval Medical Center San Diego attend a Bureau of Medicine and Surgery roadshow that brought the Army’s GFEBS rollout team to San Diego to provide training on the new system, which will be implemented at the hospital. (U.S. Navy photo by Petty Officer 3rd Class Harley Sarmiento)

ready to go full bore on day one in the full system. If we had been overwhelmed with a lot of transactions, it might have made things more difficult in the beginning, but in the long run, it might’ve put us farther ahead in the learning curve.”

CONCLUSION

In addition to Navy BUMED, GFEBS is now being used at Walter Reed National Military Medical Center, National Capital Region Medical Directorate, the Defense Health Agency and the Uniformed Services University of the Health Sciences, as well as more than 30 other organizations. Other branches of the military will likely transition to GFEBS in the future as part of DOD’s ongoing effort to modernize and streamline its enterprise resource planning systems.

The example provided by the Army-Navy partnership, accomplishing this complex transition a full year ahead of schedule,

serves as a model for those yet to make the leap. Teamwork is the new legacy.

For more information, go to <https://www.eis.army.mil/programs/gfebs> or <https://www.milsuite.mil/book/groups/gfebs>.

PAUL “PABLO” MCKELLIPS provides strategic communication support at PEO EIS for Credence Management Solutions. He served as a global outreach officer in Baqubah, Iraq (2006-2007); NATO’s public affairs trainer to the Afghan National Army’s 203rd Corps in Paktia, Afghanistan (2010-2011); press secretary at the Federal Emergency Management Agency; and strategic communication support to the Army’s Chief Information Officer/G-6. A veteran of the U.S. Air Force, he has an M.A. in international relations from the University of Memphis and a B.A. in journalism from Oral Roberts University.

STRENGTH THROUGH COOPERATION

The U.S. works to strengthen alliances, attract new partners and enhance interoperability through foreign military sales.

by Maj. Seth R. Fort

“Fuze armed” was the last transmission heard over the radio, seconds before the M982A1 Excalibur projectile hit its intended target 22 kilometers away during the Lot Acceptance Test at Yuma Proving Ground, Arizona, on April 10, 2019. Delegates from three different countries watched as dust and debris from the explosion cleared, revealing how lethality is augmented by precision. Eight months later, on Dec. 9, 2019, at the Pokhran Field firing range in India, the same lethality was demonstrated as India became the latest partner to add precision cannon artillery projectiles to its military arsenal.

In the 2018 National Defense Strategy, then-Secretary of Defense James Mattis declared “strengthening alliances and attracting new partners” as one of the strategy’s lines of effort, while highlighting “deepen[ing] interoperability” as one of the elements necessary “for achieving a capable alliance.”

The U.S. defense industry, together with U.S. military standards for testing and evaluation, provides materiel solutions that are sought after by militaries throughout the world. The demand for U.S. military materiel was enumerated in October 2019, when the Defense Security Cooperation Agency (DSCA), which is responsible for the financial oversight and program management of foreign military sales (FMS), announced \$55.4 billion in FMS during fiscal year 2019.

From senior political leaders to operators in the field, each foreign military sale provides an opportunity to strengthen alliances, attract new partners and increase multinational interoperability, while underscoring the U.S. government’s commitment to meeting a foreign military’s materiel objectives.

FOREIGN MILITARY SALES PROCESS

FMS is a carefully regulated process that requires comprehensive exchanges between multiple agencies within the U.S. and the foreign government. The process



PRESIDENTIAL PRAISE

President Trump, during his visit to India, gives recognition to members of the Office of Defense Cooperation at the U.S. Embassy in New Delhi on Feb. 25 for their pivotal role in the foreign military sale of Excalibur M982A1 projectiles. (Photo by U.S. Embassy New Delhi)

TEAM TRAINING

Indian Army soldiers together with members from Program Manager Towed Artillery Systems New Equipment Training team conduct maintenance training in India on M777A2 Lightweight Towed 155 mm howitzers following the delivery of the howitzers in May 2019. (Photo by Indian Army)



formally begins when a foreign government submits a letter of request (LOR) to obtain product pricing and availability information in support of a specific materiel objective.

Upon receipt of the letter, the corresponding U.S. Embassy's Office of Defense Cooperation, the State Department's Office of Regional Security and Arms Transfers, DSCA, the applicable implementing agency and the program office for the queried systems work together to gather the requested information.

The gathered information may be provided to the requesting government only after the appropriate agencies assess the letter of request as supportable and when "the President [of the United States] finds that furnishing the defense articles ... will strengthen the security of the United States and promote world peace," according to the Arms Export and Control Act.

If requested by the foreign government, a letter of offer and acceptance (LOA) may be issued from the U.S. government approving the continuation of the FMS case. All foreign military sales cases have underlying economic and political factors. An LOR can be denied for a number of reasons. However, if an LOA is issued, it begins a series of exchanges between the U.S. and the foreign customer. Quantities, prices and additional required items are negotiated and included in the final contract between the two governments.

Depending on the complexity of the requested systems and the parties involved, there may be variations in the FMS process.

However, once a letter of offer and acceptance is issued, all U.S. government parties diligently work to provide the requested capability to the foreign government.

ALLIANCES AND PARTNERSHIPS

Alliances and partnerships are an integral part of the United States' success. Even before declaring independence in 1776, the U.S. sought to establish both with governments that shared its objectives. When operating abroad, alliances and partnerships can provide U.S. forces a unique perspective of an area of operations; they can enhance capabilities while reducing burdens; and they can signal a higher level of commitment against an adversary.

The United States Conventional Arms Transfer Policy, updated in the National Security Presidential Memorandum (NSPM-10) in April 2018, highlights the crossroads between FMS, allies, partners and U.S. objectives. "The security of the United States and the defense of our interests require a strong military, capable allies and partners, and a dynamic defense industrial base. ... Strategic conventional arms transfers lie at the intersection of these interests and play a critical role in achieving our national, economic security, and foreign policy objectives."

Throughout the FMS process, there are numerous interactions at various levels between the U.S. and the foreign government that assist in strengthening alliances and partnerships. Upon initiating an FMS case, and during contract negotiations, senior representatives from both governments interact daily. As contracts are

formed and amended, exchanges help develop an understanding of each government's requirements and limitations.

Many FMS cases require supplemental or corresponding system acquisitions and support packages for a "total package," or more holistic approach. With each of these additional requirements, more representatives from each government enter the alliance-and partner-building effort. In most cases, these representatives work directly with their foreign government counterparts as they collaborate to accomplish fulfillment of specific contractual requirements.

At the unit or user level, unit planners and sustainers for the foreign military become involved as new equipment training is scheduled and executed. From the highest levels of government to the users in the field, the FMS process provides an opportunity for the U.S. to strengthen its ties with the foreign government.

INTEROPERABILITY

In addition to strengthening alliances and attracting new partners, FMS also increases interoperability between the U.S. and foreign militaries.

The Defense Standardization Program, together with test and evaluation plans and standards, "provide the warfighter with equipment that is interoperable, reliable, technologically superior and affordable," according to DOD Manual 4120.24, issued Sept. 24, 2014. To accomplish this, the systems and ammunition used by the U.S. military undergo extensive testing and evaluation before being fielded and further proven on the front lines. Because of these standards and the subsequent quality that is achieved, militaries throughout the world seek to acquire U.S. military products through FMS.

During the foreign military sales process, information is often shared between the U.S. and the foreign customer on the architecture of the acquired systems to assess compatibility between the newly purchased systems and existing systems. To establish compatibility, FMS cases often require additional tests, evaluations and system modifications. Munitions are tested on new foreign weapon systems, software modifications are developed and tested and all potential system and user touch points are assessed to ensure complete compatibility.

FMS cases result in U.S. and allied militaries operating with compatible systems, which in turn enhances multinational interoperability. The importance of interoperability is stated repeatedly in TRADOC Pamphlet 525-3-1, "The U.S. Army in Multi-Domain Operations 2028." "Interoperability across service, interagency, and multinational partners is a key element to executing MDO [multidomain operations]." FMS promotes interoperability, which then "builds capacity and expands the range of options for the joint force commander."

Interoperability considerations can range from technology and equipment to training and cultural factors, all of which can be directly impacted by FMS. The processes involved during an FMS case, from contract negotiation to fielding, help support interoperability at the strategic, operational and tactical levels.

PARTNERSHIP FOR MODERNIZATION WITH INDIA

As one of the largest armies in the world, the Indian Army has, over the past decade, focused on modernizing its artillery forces. One of the most notable steps to modernize the artillery came in September 2018, when India received its first delivery of the U.S. M777A2 Lightweight Towed 155 mm howitzers.

ON TARGET

An M982A1 Excalibur projectile detonates directly over the target vehicle during a Lot Acceptance Test on April 10, 2019, at Yuma Proving Ground, Arizona. (Photo by Yuma Proving Ground)



Throughout the FMS case for M777A2 howitzers, Program Manager Towed Artillery Systems (PM TAS), together with multiple U.S. government agencies and organizations, worked diligently with the Indian government to ensure the acquisition and fielding of the howitzers, while strengthening the partnership and shaping future operations. The relationship and trust built between PM TAS and the Indian Army proved key to the follow-on effort to equip the howitzer with the Excalibur projectile.

The second step occurred in May 2019, eight months after delivery of the first M777A2s, when the Indian government submitted a request for M982A1 Excalibur projectiles. Over the next five months, during one of the fastest FMS cases in U.S. Indo-Pacific Command's history, Program Manager Combat Ammunition Systems (PM CAS), along with representatives from other U.S. agencies, commands and offices, collaborated its efforts and worked directly with their Indian counterparts to overcome obstacles and meet India's requested delivery date. During early discussions, PM CAS identified critical associated items such as the propellant, training package and fuze setting system to enable the fastest path to qualification that were also added to the effort.

On Oct. 13, 2019, M982A1 Excalibur projectiles, along with several supplementary systems, were delivered to Mumbai, India. Less than two months later, on Dec. 9, following a three-week new equipment training, Indian artillery instructors and Soldiers at the Pokhran Field firing range in India successfully employed M982A1 Excalibur projectiles with M777A2 howitzers at targets ranging from 17 to 36 kilometers, each time achieving the desired effects while impacting the intended targets with precision.

Building upon the success of these and other FMS cases, on Feb. 24, during his visit to India, President Donald Trump announced the U.S. was working with India to sign agreements for more than \$3 billion in planned military sales. As with other allies and partners, through past and future FMS, the U.S. will strengthen its partnership with India, while building interoperability between the two militaries.

CONCLUSION

The 2018 National Defense Strategy states, "The willingness of rivals to abandon aggression will depend on their perception of U.S. strength and the vitality of our alliances and partnerships." Each FMS provides the acquisition community, along

with other U.S. government agencies and organizations, an opportunity to support the National Defense Strategy by strengthening alliances, attracting new partners and increasing multinational interoperability.

The Defense Standardization Program, together with the requirements for test and evaluation, result in U.S. military systems and ammunition that are effective, reliable and affordable. Consequently, these tested and proven products are sought after by militaries throughout the world.

During the FMS process, the U.S. government works closely with the foreign government to accomplish a common goal and provide a materiel capability. The FMS process results in regular engagements between both governments, as well as product modification and integration. Each of these actions help support multinational interoperability and further strengthen U.S. alliances and partnerships.

For more information on foreign military sales to go <https://www.dsca.mil>. For more information on Excalibur or M777 to go <https://jpeoaa.army.mil/jpeoaa/>.

MAJ. SETH R. FORT is an assistant product manager with Product Manager Precision Attack Cannon Munitions, Project Manager Combat Ammunition Systems, Joint Program Executive Office for Armaments and Ammunition. He holds an MBA from The College of William and Mary, and a B.A. in government and international politics, with a minor in Islamic studies, from George Mason University. He is Level II certified in program management.





A PROBLEM SOLVER TAKES ON ACQUISITION

Since he was just a kid, Giovanni Oddo has been fixing things. The middle child and only boy in his family, he stepped into the role of the household “fixer-in-residence” while his dad worked nights building, repairing and later managing newspaper presses. Or, as he explained it, “I had to learn how to do all the chores the girls didn’t want to do.” The role was a natural fit for Oddo, who had always loved tinkering and learning how things worked. “I always wanted to take things apart and modify them,” he said. “I wanted to know how things worked.”

GIOVANNI ODDO

COMMAND/ORGANIZATION:

Product Lead for Tactical Network Initialization and Configuration, Project Lead for Network Enablers, Program Executive Office for Command, Control and Communications – Tactical

TITLE: Assistant product manager, Initialization Tools Suite/Product Support

YEARS OF SERVICE IN WORKFORCE: 11**DAWIA CERTIFICATIONS:** Level

II in program management, Level II in information technology

EDUCATION: M.S. in systems engineering, Johns Hopkins University; B.A. in informatics, Rutgers University

AWARDS: C5ISR Top 10 for 2019; Department of the Army Achievement Medal for Civilian Service 2019

In college, his curiosity and natural aptitude led him to a new kind of problem-solving. He began building data-driven websites for local businesses as a way to pay his bills. “I built custom websites for real estate firms, hair salons and a couple of pizzerias,” he said. In the days before Zillow, just as Amazon was coming online, there was a huge demand for public-facing e-commerce websites for businesses. Oddo was Johnny-on-the-spot, and this foray into the world of technology was the beginning of a career he couldn’t yet anticipate.

Oddo was working as an IT risk specialist at an investment firm during the financial crisis in 2009. Looking for stability and hoping to do more practical, hands-on problem-solving, he started his first government job at Fort Monmouth, New Jersey. “As the new guy in a DOD job, I couldn’t believe what I was seeing,” he said. He was surprised by the sheer complexity and breadth of the Army workforce. He started out doing research and development (R&D) in the network operations branch of the Space and Terrestrial Communications Directorate at what was then the Communications-Electronics Research, Development and Engineering Center. That has since become the U.S. Army Combat Capabilities Development Command C5ISR Center.

It was there that he learned an important lesson about solving problems for Soldiers. “In the R&D side, we were a little too optimistic,” he said. He and his team had designed a device that would use cutting-edge technology to converge multiple networking tools onto a single platform, saving time and effort for Soldiers. “We took it to Fort Polk [Louisiana], and they loved it. But then I found a major challenge—that was taking the solution from a good idea to a reality,” he explained.

“We didn’t necessarily account for what was in the field at that time,” a combination of disparate network operations tools that lacked system-of-systems integration. “Our product wouldn’t integrate well,” Oddo said. He now understands that that’s where the rubber meets the road for Army acquisition. “The challenge is never the technology. The hardest part is integration. We can build a solution, but if it doesn’t fit with the other pieces of the puzzle, then it’s useless,” he said. “When I



NETWORKING

Giovanni Oddo's job revolves around initialization products, which assign every system in a command post a unique identifier, role, and Internet Protocol address—a numeric designation that identifies its location on the internet. Each act of initialization takes into account a unit's specific mission, personnel footprint and mix of networked mission command systems. The result is identifying information that enables the various systems to connect and share information. (Photo courtesy of PEO C3T)

started in R&D, I was further away from the acquisition process. I knew after a year of working in that area that I wanted to be in the program office.”

That lesson stuck with him. In 2018, he was selected as the assistant program manager for Product Lead Tactical Network Initialization and Configuration (TNIC), within the Network Enablers program management office at the Program Executive Office for Command, Control and Communications – Tactical (PEO C3T). TNIC works to secure the Army's tactical network, simplify network operations and streamline hardware and software solutions for operational units and program management offices.

“The one-liner is that we build all the data products and network configurations for tactical Army units,” Oddo explained.

“Imagine you buy a brand new cellphone. When you turn it on for the first time, there are already things going on in the background, unbeknownst to you,” he said. Your phone will connect to the nearest cell tower and then be routed through the network, for example. That information is all preconfigured, usually by the carrier. Similarly, “We create the phone numbers, IP addresses, routing information, and all the information required by the equipment on the tactical Army side,” he said.

That's something he really enjoys about his work. “We don't build a specific product. We make products for *everything*.” He and his team have to understand all the requirements and the ways in which the puzzle pieces fit together. “We work with all sorts of stakeholders to gather that information and put it together.

Every piece has to fit just right,” he said. To make that happen, Oddo said, the key is communication.

“Communicating early and often throughout the life cycle with all stakeholders, teammates, leadership and end users is vital,” he said. Only with good communication can the team ensure that it is purchasing or developing the right solutions for Soldiers. In fact, Oddo would rank communication skills above unique technical expertise if he were hiring someone for his current position. “It helps to have at least a foundation in technology, but you don't need to be a master of a certain skill,” he said. “We work with super-smart subject matter experts, so it's more important that you can speak their language and communicate effectively with our stakeholders.”

Oddo has seen many things change since he started working in Army acquisition 11 years ago. The biggest, he named without hesitation. “The Army Rapid Equipping Force and the use of the OTA (other-transaction authority),” he said. “Without a doubt, they are the biggest acquisition movers I've seen over the last decade.” That's high praise from a guy who always tinkers with process improvement and wants to understand how things work.

Ultimately, Oddo said he has found his niche. “My life before becoming a government civilian was hopping from one tech job to the next, so I can't believe I've been here this long.” But he isn't looking for the offramp anytime soon. “I take immense pride in supporting our country and our Soldiers,” Oddo said. “I did not serve, but I have the greatest admiration and respect for them. I love that feeling of pride here, and I don't want to go anywhere else.”

—ELLEN SUMMEY

FREE, URGENT AND SCARCE

The Army's xTechSearch program leverages its success to find the innovation the Army needs—and reveals good old American ingenuity.

by Christopher J. Semancik

The COVID-19 pandemic hit the United States rapidly, and with little time for Americans to prepare for what we were about to face. Instantly, there were equipment shortages all over the nation, ranging from personal protective equipment (PPE) such as gowns, masks, and gloves to shortages on complex medical devices like ventilators.

The COVID-19 crisis provided an opportunity to demonstrate the speed of discovery to potential acquisition that can keep up with emerging and changing Army operational requirements that the xTechSearch program offers the Army.

On April 5, the Army put out the call for ideas to respond to a problem statement for a low-cost, easily manufactured, deployable ventilator technology that could operate in austere and rural environments. The Army was searching for a solution that could be used in the long term, to not only support the nation in times of need but also to continue supporting warfighters and medics during field operations.

SPEED TO CONTRACT

In just 10 days, 150 American companies, academic institutions and individuals submitted concepts for review by Army scientists and engineers, healthcare clinicians and medical doctors.

The evaluation criteria included mission requirements, technical viability, regulatory burden and the ability to deliver 10,000 functional units at an enhanced production speed. Just 16 days after the U.S. Army acquisition executive launched the Expeditionary Technology (xTech) COVID-19 Ventilator Challenge, a panel of Army judges made its initial recommendations for potential limited acquisition. The competition facilitates access to other-transaction authority contract vehicles that enable delivery of prototypes for additional government testing.

At the conclusion of the COVID-19 Ventilator Challenge, which ran for just 20 days, the xTech program received and processed more than 200 technology submissions resulting in 11 companies being invited for virtual pitches. Five of those companies were selected as winners, each receiving a \$100,000 cash prize. The winners quickly entered into potential contract negotiations with the Army, representing a substantial cost savings and demonstrating speed and flexibility to respond to emerging requirements.

XTech worked, at speed, to seek and locate novel dual-use technology and evaluate it, just as it was envisioned. The COVID-19 Ventilator Challenge accomplished its technological review in less than a month, proving that American technology was available to quickly meet the requirement and that the xTech program's format could respond quickly to Army operational needs.

AS ENVISIONED

Dr. Bruce D. Jette, the assistant secretary of the Army for acquisition, logistics and technology (ASA(ALT)), in a recent interview hosted by the Army xTechSearch Accelerator, explained how he conceived of the Army prize competition known as xTechSearch. “The idea was, how do I open a door for people with great ideas and great opportunities to come and participate in sharing their ideas,” he said. “Congress was good enough to give us what is called ‘contest authority,’” and Jette used that to generate the xTechSearch. “My objective was to generate a mechanism by which people could bring their ideas forward, get them seen by the right people [and] get feedback by the right people.” Jette noted that small businesses and startups are often at the leading edge of scientific inquiry and technology development, but are often reticent to engage with the Department of Defense.

So what makes xTech so successful? According to Josh Ledgard, the founder of kickofflabs.com, a contest-hosting website oriented to promoting small businesses, there are strong psychological factors associated with opportunities that are free, urgent and scarce, which bring a broad appeal to contests and drive participation.

Army prize competitions are executed under Title 10 United States Code (USC) Section 2374a or Title 15 USC Section 3719. The psychological drivers of free, urgent and scarce are designed into the xTechSearch construct. Submission deadlines and juried elimination events for non-dilutive seed money provide the “urgent” and “scarce.” The maximum amount that the grand prize winner can receive through all four phases is \$385,000. (Non-dilutive seed money enables the business to receive money for its intellectual property without sacrificing a portion of its ownership.)

Besides the cash, participants gain access to a host of additional benefits, including detailed product and business-model feedback from Army subject matter experts, xTech Accelerator team events and Army-sponsored networking opportunities at national level land warfare conferences. In addition, the winner may gain access to government labs and testing facilities through cooperative research and development agreements with the Army.

FREE BUT PRICELESS

The cost of entry? A concept white paper outlining the technology, potential impacts, scientific viability and dual-use applications. Although there is no fee to send in the white paper, as Jette observed about tech entrepreneurs, “...what they have in their head is their resource, what they have in their head is their

VENTILATOR CHALLENGE

These are the selected winners of the xTech COVID-19 Ventilator Challenge, Part 2: Prototype Proposals.

AIRMID CRITICAL CARE PRODUCTS, INC.

This company created a non-Ambu bag convertible ventilator that is a volume-controlled resuscitation device with reliable safety features and dual-mode operational capability for versatility of use in environments requiring hand-operated manual use or mechanized automated use. (Ambu is a ventilator-maker not involved in the competition that “developed the world’s first self-inflating resuscitator, that was designed for manual ventilation,” according to its website. Their ventilators use a bag known as an Ambu bag.)



DUAL USE

The ventilator designed by AirMid Critical Care Products is convertible, meaning it can function in either a handheld or a machine-operated capacity. It is also meant to prevent over-inflation of the lungs during manual ventilation. (Photo courtesy of AirMid Critical Care Products Inc.)

Continued on next page

capital value...,” and the concept paper represents that capital investment in the competition.

Since its inception in April 2018, the Army xTechSearch program has evaluated more than 1,500 dual-use technologies for potential application to Army modernization priorities. Currently running its fifth open-topic iteration, which is set to conclude in the spring of 2021, xTechSearch has evolved into an overarching program including both open-topic and directed-topic competitions to tackle specific problems; an accelerator program that seeks to develop xTech competitors into viable companies; and an expanding set of partners across the Army, the Department of Defense and the world.

Army partners that comprise the Army innovation ecosystem, and that are actively engaged in the xTechSearch program, include Army Futures Command (AFC) and its constellation of laboratories and testing facilities, the Army Applications Lab, the Army Rapid Capabilities and Critical Technology Office (RCCTO), the 75th Innovation Command (an Army Reserve component), the Army Corps of Engineers and Army Materiel Command (AMC). These organizations provide the xTechSearch program with a powerful resource of experts to power the prize competitions’ ability to rapidly evaluate science and technology proposals from a broad spectrum of disciplines across all phases of the acquisition life cycle.

URGENT

As opposed to the current 15-year concept-to-fielding process, the prize competition authority model provides the Army with a rapid alternative means to discover and potentially acquire novel dual-use science and technology from virtually any source, on a compressed schedule.

The technology-readiness level (TRL) scale is one of the metrics that xTech judges use to review and classify the maturity of proposed technology. The scale runs from 1 to 9, with TRL 1 representing the lowest level of readiness dealing with the observation and reporting of basic principles through a paper study that may contain a proposal for application. TRL 9, on the other end of the scale, would be applied to technology that can be tested and evaluated under actual field conditions, with hardened prototypes ready to transition to full production.

As an example, in recent xTechSearch phase II technology pitches, 16 of the 20 companies selected offered examples of desired technological solutions to Army problems that the panel of Army judges rated as TRL 5 or above, meaning that the solutions were capable of demonstrating their value. Thus, in the space of a few months and, at minimal cost to the Army, the xTech process documented specific technology that answered the problem statement of a sufficient maturity to move along to the prototype and testing phase.

Problem statements developed by experts, standardized review metrics, and a systematized and automated judging structure enable xTech judges to proceed at a high level of speed and fidelity, resulting in accelerated decision making.

The xTech program has proven to be a popular and flexible platform for technology scouting. The open topic format has brought forward technologies as diverse as a more efficient rocket motor propellant to a handheld wall-penetrating radar, to topic specific competitions such as the xTechSearch COVID-19 Ventilator Challenge. When faced with the cancelation of in-person programs because of COVID-19, the xTechSearch team seamlessly transitioned to virtual events, a switch

that has served to extend opportunities of accessibility and participation across all the associated stakeholders.

Moving to a virtual format has further lowered event overhead costs and has increased the speed and frequency at which contest iterations can be held. “I was amazed at how interactive the virtual competition was and how much dialogue we could have on the technology in ten minutes,” said Keith Jadus, director for the Ground Maneuver/Next Generation Combat Vehicle portfolio in the Office of the Deputy Assistant Secretary of the Army (DASA) for Research and Technology (R&T) after participating in a recent xTech virtual event.

SCARCE

Even before it initiated the Ventilator Challenge, AFC was exploring how to leverage the xTechSearch program to meet immediate Army needs. AFC’s Innovation Combine (See “Great American Novel Technologies,” Page 72), which took place from April 15 to July 15, expanded the topic-driven prize competition to include two very specific topics open to all business types with an option to join a consortium that has an existing other-transaction authority agreement at the end of the competition. All finalists were eligible for other-transaction authority agreement awards through the National Advanced Mobility Consortium. Two winners were selected for awards during the Innovation Combine event and the remaining six companies have their proposals placed in the “Ground Vehicle System other-transaction authority electronic basket” that makes them eligible for an award until June 17, 2023.

The wording and construction of the two Innovation Combine topics and problem statements are instructive to what makes a topic-driven competition work efficiently:

SISU

SISU is an industrial robotics company that developed an Ambu-bag solution known as the Austin P51 emergency ventilator. The ventilator solution is built into a rugged Pelican case and squeezes a standard Ambu bag connected to a U.S. Food and Drug Administration-approved standard circuit with a positive end-expiratory pressure valve and high-efficiency particulate air filter. The solution was developed in collaboration with clinical specialists at Mount Sinai and Baylor University hospitals and provides comprehensive capabilities for Ambu-bag solution, while considering Army-specific needs for forward-deployed operations.

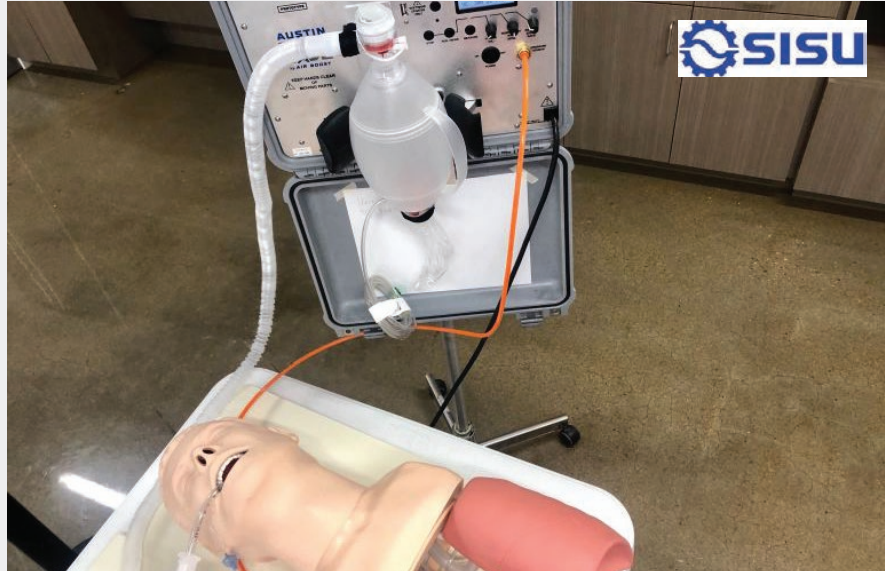

A FIGHTING CHANCE

SISU's P51 Air Boost ventilator, named after the World War II-era P-51 Mustang fighter plane, features 3D-printed "fingers" that compress the bag and move air into the patient's lungs. (Photo by Alyssa Goard, KXAN)

SPIRO DEVICES, LLC



PLUG AND PLAY

The Spiro Wave automatic resuscitator was designed to work with standard medical components widely available in most hospitals. (Photo courtesy of Spiro Devices LLC)

SPIRO DEVICES

Spiro Devices developed a low-cost automatic ventilator called the Spiro Wave. It is compatible with the standard Ambu and other ventilator bags used in clinical settings. The device features a suite of software, sensors and safety technologies to enable clinicians to monitor and adjust critical parameters.

Continued on next page

Topic A: Scalable power and energy solutions

Problem Statement A: The Army has a need for lighter, energy dense, safe, rechargeable batteries that can be demonstrated at the battery prototype level of 400 watt hours per kilogram (Whr/kg) (cell level 500Whr/kg), or a small form-factor power-generation system that could include fuel cells or small engine technologies to recharge batteries while on the move, that is light weight (<5-6 lbs. including fuel).

Topic B: Novel materials for weight reduction and survivability

Problem Statement B: For military ground vehicle structures, ballistic and blast-load requirements often trump structural requirements, leading to very thick structures. Contrary to aerostructures, for thick ground vehicle structures, materials with high strength and elongation capabilities are better than those with ultra-high stiffness. To enable lightweight military ground vehicles, there is a need for affordable materials that are resilient to high loading rate events and are able to absorb large amounts of energy without breaking.

“The broad problem statement from AFC gave enough leeway for both battery and generator technologies to be submitted,” said Dr. Imee G. Smith, director (A) of the Soldier and Squad Science and Technology portfolio for ODASA R&T, and one of the judges for the Innovation Combine. “This gave us, as judges, the opportunity to evaluate the potential impacts of each type of technology for a Soldier’s needs without constraining us to a single use case.” Keith Jadus, another Innovation Combine judge, agreed, noting that “...the AFC problem statement to reduce the weight of ground vehicles was very relevant and I saw a lot of opportunity to do this in the four companies that I reviewed.”

CONCLUSION

The problem statements of the Innovation Combine and the COVID-19 Ventilator Challenge demonstrate the potential of how the xTechSearch program can change the acquisition process. “If you go to classic acquisition documentation, it talks about requirements. In the past then, we were very specific about other aspects of whatever we are asking for... What we are trying to do now is leverage modern technology in a more reasonable manner,” Jette said, when commenting on the changing Army requirements documents. “We are not going to put a requirement in for phase one. We are going to put in a characteristic set for phase one—we are putting book ends—what you do between the book ends, we open the door, we give you the flexibility.” As with the COVID-19 Ventilator Challenge and the Innovation Combine, the problem statements did not constrain innovators into one technology solution. This results in choice in Army acquisition to meet specific needs.

This fall will see the completion of xTech 3 and xTech 4. XTech 5 will be in Phase III semifinals.

As the xTech program evolves, the Army innovation ecosystem that contributes to the program keeps exploring pathways to achieve further strategic alignments with other Army programs and authorities to fulfill a complete competition-driven technology discovery to acquisition lifecycle.

During the summer of 2020, the U.S. Army Medical Research and Development Command rearranged the traditional phases of the xTechSearch program and announced the Brain Operant Learning Technologies (BOLT) prize. The xTech BOLT prize is a research topic that is focused on exploring neural learning pathways, seeking to improve military training outcomes through optimal

There are strong psychological factors associated with opportunities that are free, urgent and scarce, which bring a broad appeal to contests and drive participation.

memory retention and access. The prize competition benefits from all the procedural developments to the xTech program to date, and starts with a 60-day white paper challenge to select up to 10 competitors for an innovative excellence award of \$10,000. As many as five of those finalists will go to Phase II, with a year to refine their research and compete for core research funding and the final prize of \$500,000. Phase I and Phase II will be announced in November and December of 2020, with the finalists selected in 2021. The xTech BOLT prize topic proves the program is flexible and boundless, seamlessly moving from research to advanced technology to rapid prototype acquisition.

For more information on the Army’s xTechSearch program, visit <https://www.arl.army.mil/xtechsearch>.

CHRISTOPHER J. SEMANCIK is an information liaison specialist with the Laboratory Management Directorate, Office of the Deputy Assistant Secretary of the Army, Research and Technology, Assistant Secretary of the Army for Acquisition, Logistics and Technology. He is a graduate of the U.S. Army War College and holds a master’s degree in Strategic Studies.

WOODWARD, INC.

In collaboration with Colorado State University, Woodward Inc. developed a unique technical solution leveraging high-performance automotive components to deliver superior ventilator capability. The Aether 100 emergency ventilator is a fully digital solution utilizing high-speed, high-flow gaseous fuel injectors to shape inhalation flow to the patient. The components of the solution are ruggedized and integrated into a compact Pelican case.



TAKING FLIGHT

Engineers for the industrial and aerospace controls manufacturer Woodward Inc. discuss the Aether 100 ventilator project, which features fuel injectors to send oxygen to a patient’s lungs. (Photo courtesy of Colorado State University)



READY, SET, GO

The ventilator designed by World Ventilator Foundation is intuitive, requiring less than 20 minutes of training for health care providers to safely operate the device. (Photo courtesy of World Ventilator Foundation)

WORLD VENTILATOR FOUNDATION

World Ventilator Foundation developed a Pandemic Rapid Response Ventilator solution that is compact and features a pneumatic subsystem and sensors for effective volume-control ventilation. The device operation mechanism uses compressed oxygen drive gas mixed with entrained ambient air. The solution is easy to use, lightweight and portable so it can be deployed rapidly to epidemic “hot spots.” It provides safe, adjustable volume-assist controlled ventilation—the most commonly used mode for critically ill patients.

—JESS STILLMAN

GREAT AMERICAN NOVEL TECHNOLOGIES

Innovation Combine finds better, cheaper and faster in more ways than one.

Finding novel technology solutions to the Army's modernization challenges is just that—challenging. This was the case for the U.S. Army Combat Capabilities Development Command Ground Vehicle Systems Center (CCDC GVSC) as it searched for ways to enable lightweight military ground vehicles with affordable novel materials for weight reduction and survivability. The CCDC Soldier Center was also looking for scalable power and energy solutions—innovative ways to find lighter, energy dense, safe and rechargeable batteries.

Part of the Army Futures Command, these organizations collaborated on a different approach to solving their problems. They wanted to discover solutions that the Army might not know were out there from the innovative small business and startup communities. The group came up with the idea of the Innovation Combine, a problem-specific pitch competition that offered an opportunity for an other-transaction authority-based contract at the end that would enable the companies to continue working with the Army, in addition to receiving a prize-money award.

“The Army Futures Command built the Innovation Combine around the idea that a pitch competition is a means to an end. Our goal was to attract small businesses, investors, academia and industry to a networking event and focus their attention on Army problems,” explained Lt. Col. Anita McGinthy, Army Futures Command orders and events manager. “We advertised the event as a pitch competition, and then we built the competition within Army programs. We combined CCDC's model for a focused competition for contract awards, with the ASA(ALT) [assistant secretary of the Army for acquisition, logistics and technology] model for a broad competition for cash awards. Then, we invited all of the small businesses who responded to the event—not just those selected to pitch at the event. Because the competition was nested within Army programs, the small businesses themselves drew the investors, industry scouts, academia and other cohorts seeking to do business with the Army.”

This first-of-its-kind competition used the framework and business model developed for the Army's Expeditionary Technology Search (xTechSearch) competitions and blended it with CCDC GVSC's “flash-to-bang”



THE LOWDOWN

Dr. Douglas Tamilio, director of the U.S. Army Soldier Center, provided an overview of the Army's need for scalable power and energy solutions. (Photos courtesy of U.S. Army CCDC)

other-transaction authority process. They wanted to attract companies from the nontraditional industrial base to provide an easier way to work with and engage the Army. Through the pitch competition, those innovators would be able to network, make connections and learn about how to do business with the Army.

One of the unique benefits of the Army pitch competition model used by the xTech Search program is that it works to bring potential Army customers to the companies to listen to their pitches and understand their technologies. The idea is that the small companies can start developing a relationship between Army subject matter experts and technology innovators. Not only does the Army want to invest in innovation, it also wants to invest in future suppliers by assisting in making connections with them.

HOW THE INNOVATION COMBINE WORKED

The Innovation Combine launched on March 15 and included two problem statements:

Scalable power and energy solutions: The Army has a need for lighter, energy dense, safe, rechargeable batteries that can be demonstrated at the battery prototype

level of 400 watt-hour per kilogram (Whr/kg) (cell level 500 Whr/kg), or a small form factor, lightweight (less than 5-6 pounds, including fuel) power-generation system that could include fuel cells or small engine technologies to recharge batteries while on the move.

Novel materials for weight reduction and survivability:

For military ground-vehicle structures, ballistic and blast load requirements often trump structural requirements, leading to very thick structures. Contrary to aerostructures, thick ground-vehicle structures need materials with high strength and elongation capabilities rather than ultra-high stiffness materials. To enable lightweight military ground vehicles, there is a need for affordable materials that are resilient to high loading-rate events and are able to absorb large amounts of energy without breaking.

The challenge of novel materials for weight reduction and survivability is relevant to CCDC GVSC. “As we look to integrate advanced capabilities onto these platforms, lightweight materials are necessary to offset the added weight from sensor packages, power terrain upgrades and more. Lighter-weight vehicles can be transported easier and at lower cost. Moreover, these vehicles with increased mobility may lead to more favorable outcomes in theater,” explained Dr. Robert Hart, senior mechanical engineer at CCDC GVSC.

Scalable power and energy will help to address power demands that are expected to increase as Army modernization continues. Dr. Douglas Tamilio, director of the CCDC Soldier Center, explained that “left as is, the current commercial batteries and small power-generation systems will not satisfy the higher demand without increasing the physical and cognitive load on our Soldiers. Scalable power and energy are so important.”

In Phase 1, U.S.-based companies submitted their white papers outlining their respective technologies and viability, the potential impact on the Army and other dual-use cases. A panel of Army judges reviewed the white papers and selected 28 companies to compete in Phase 2 and earn a cash prize of \$5,000 each.

During Phase 2, the 28 companies submitted prototype project proposals, with eight finalists then selected to present their projects at the Innovation Combine event July 14–15. The 20 runners-up were invited to participate at the Innovation Combine event with free booth

“A pitch competition is a means to an end. Our goal was to attract small businesses, investors, academia and industry to a networking event and focus their attention on Army problems.”

space and the opportunity to host office hours, to take full advantage of the networking experience. The selected finalists, four for each topic area, also joined the National Advanced Mobility Consortium, making all eight finalists eligible for an other-transaction authority agreement.

For Phase 3, the final presentations were held at the Innovation Combine, part of a first-of-its kind virtual conference called the Fed Supernova, held July 14–16. The Fed Supernova was hosted by the Capital Factory in Austin, Texas, connecting leading entrepreneurs, investors, thought leaders, corporations and defense industry decision-makers.

The two winners, TexPower Inc. and FPH USA, were selected for other-transaction agreements during the Innovation Combine event and received an award of \$45,000 each. The remaining six companies received \$15,000 each and will have their proposals placed in the “GVS other-transaction authority electronic basket,” making them eligible for an award until June 17, 2023. Read more about their technologies below:

TOPIC A: SCALABLE POWER AND ENERGY SOLUTIONS

TexPower Inc., from Austin, Texas, was the winner of Topic A for its cobalt-free high-energy lithium batteries. Their next-generation battery solution can lengthen battery life without relying on costly metals to manufacture. Using a cobalt-free, ultrahigh-energy cathode and lithium metal anode, TexPower’s solution can be simple and flexible for modern Army equipment reducing the need for heavy and complex auxiliary power sources.

Black Diamond Structures, from Austin, Texas, developed a discrete carbon nanotube additive for enhanced performance and safety of Army lithium ion batteries,

called Molecular Rebar. This nanomaterial derivative is based on proprietary discrete carbon-nanotube technology that augments battery active material and increases energy density by enabling higher silicon percentage loadings while also enhancing the lifecycle and reducing impedance growth.

LiquidPiston Inc., from Bloomfield, Connecticut, developed a compact and efficient rotary diesel combustion engine. The company’s “gearless” version of its rotary diesel “X” engine is 90 percent smaller and lighter than a piston engine, while also 30 percent more fuel efficient and capable of being scaled down to less than one horsepower. The system with one cartridge exceeds 400 Whr/kg, and it approaches 600 Whr/kg with two cartridges.

Spark Thermionics, from Emeryville, California, pitched small form factor, flexible thermionic generators. Electrons evaporate from a hot electrode into a vacuum gap and are collected by a cooler electrode, generating current. Their key attributes include extremely high power density, simplicity and modularity, scaling for any power need from individual Soldier (20-plus watts, proposed here), to small squad or platoon power (300-plus watts) and beyond.

TOPIC B: NOVEL MATERIALS FOR WEIGHT REDUCTION AND SURVIVABILITY

FPH Group USA, from Roseville, Michigan, was the winner for Topic B for its novel materials for weight reduction and survivability called FPH-Tough (FPH-T). FPH-T is a unique combination of lightweight, durable and high-modulus constituents that provides an alternative to glass-fiber composites and metallics. The company proposed a final prototype to be a completely validated rear ramp door for the U.S. Army’s Stryker vehicle, proving a weight reduction of approximately 50 percent and improved survivability.

Mafic USA, from Shelby, North Carolina, developed a solution using basalt high-performance composite fabric as vehicle armor. This technology reduced weight and cost while retaining comparable protection capabilities. This recyclable and sustainable fabric is lightweight with ballistic-, blast- and shockwave-protection capabilities.



FIRST OF A KIND

Final presentations were held July 14–16 during a first-of-its-kind virtual conference called the Fed Supernova, at the Innovation Combine. The virtual conference was hosted by the Capital Factory in Austin, Texas.

Maynard Steel Casting Co., from Milwaukee, developed lightweight, all-steel, precision-engineered, low-density prototype panels for use in military ground vehicles using a patented sand-cast process. This proposed solution can enable the Army to utilize a lightweight ballistic and blast material for military systems and significantly reduce overall vehicle weight while retaining or improving ballistic protection.

UHV Technology Inc., from Lexington, Kentucky, presented an affordable option for manufacturing military-grade lightweight metal alloys from recycling domestic automotive scrap. This cost-saving solution includes a patented aluminum recycling sorting technology that uses the latest artificial intelligence combined with a melting process of low silicon aluminum alloys.

—KRISTIN MCNELIS

10 GOOD IDEAS

| The Army's xTechSearch program uncovers value and innovation.

A panel of Army experts chose 48 concept white papers from the 351 submitted for Phase 1 of the fourth cohort of technologies for the Expeditionary Technology Search (xTechSearch) at the Association of the United States Army (AUSA) Annual Meeting and Convention in October 2019. Each small company moved on to Phase 2 and received an award of \$5,000.

Phase 2 contestants presented a 15-minute in-person technology pitch followed by a 10-minute question-and-answer sessions with a panel of Army technical experts at various locations across the United States, including Playa Vista, California, Austin, Texas, and Philadelphia. The Army invited 20 of the 48 competitors to move on to the semifinals and awarded each a prize of \$10,000.

BOUNCE IMAGING

Bounce Imaging provides a tactical throwable camera that could be used to gather vital information from a safe distance. The device captures 360-degree panoramic video and audio, and transmits it in real time. The panoramic video is stabilized, ensuring the spherical camera body does not need a specific up-direction. Teams that face immediate dangers can use the low-cost and easy-to-deploy system to gain vital information to keep themselves and civilians safer.



EYES IN THE BACK OF ITS HEAD

The Explorer – Recce 360 is a round camera that streams audio and 360-degree video in real time. (Photo by Bounce Imaging)

The Phase 3 semifinals were interrupted by the COVID-19 pandemic and had to be conducted virtually. Each small business competitor provided a detailed 10-minute pitch, after which an Army panel of experts held a 10-minute question-and-answer session. Ten of the 20 small businesses were selected for the finals and received an award of \$120,000.

Each of the finalists will provide a live proof-of-concept demonstration to a virtual audience during the 2020 AUSA annual meeting, October 12–14. One grand-prize winner will be selected during the virtual event and will receive a prize of \$250,000. All other finalists will receive an additional \$10,000. Here are the xTechSearch 4 competition finalists and snapshots of their technology concepts:

GENECAPTURE

GeneCapture provides a portable rapid infection diagnostic that identifies the genetic signature of a pathogen using direct RNA hybridization. The unique approach to the diagnostics of diseases allows GeneCapture to use RNA-based technology to bring infection detection to the point of care.

GeneCapture



TESTING 1-2-3

GeneCapture created a device that can test for hundreds of pathogens in under an hour, at a cost of less than \$20. (Image by GeneCapture)

INDUCTIVE VENTURES

Inductive Ventures created an active magnetic brake design that provides magnetic braking and electric taxi capabilities to the rotorcraft. The braking system is a direct replacement for the carbon-steel brake currently used onboard and will fit within existing spaces. The active braking solution provides rotorcraft with the ability to not only brake the aircraft but also taxi the aircraft in arduous environments without the use of the main rotor.

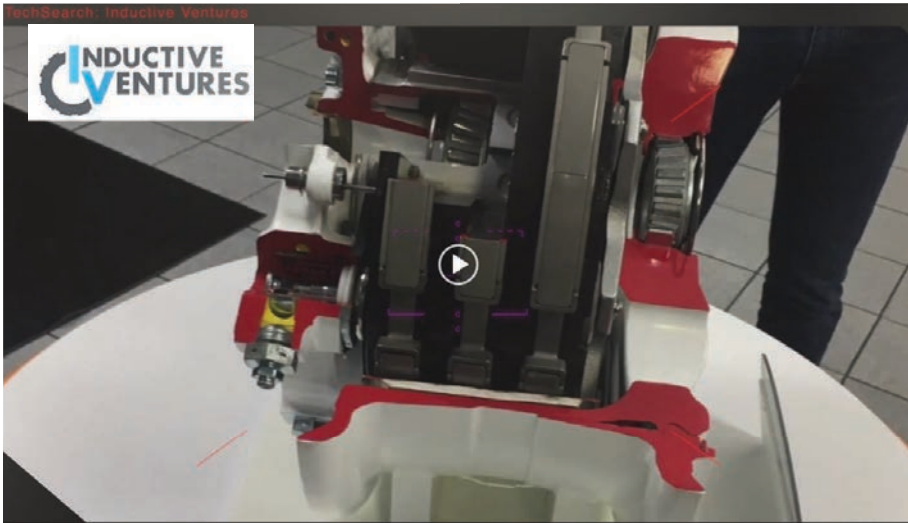

A QUICK STOP

The Inductive Ventures magnetic brake is a retrofit design that can replace the existing brake pads and rotors on military aircraft, drastically reducing maintenance needs. (Image by Inductive Ventures)

IOT/AI INC.

IoT/AI Inc. provides an “edge as a service” system that is easy to deploy and will provision real-time monitoring, data collection, distribute artificial intelligence and machine learning, collaboration and decision support. The edge platform supports more than 4,000 sensors and is an unmatched combination of tactical radio, edge computing, sensor integration and edge AI and machine learning in a commercial off-the-shelf-based military specification-certified, and anti-access and area-denial-resistant system, low probability of intercept and low probability of detection, low radio-frequency, tactical, maintenance, training, health, chemical, biological, radiological, nuclear and high yield explosives, Internet of Things, etc.

TACTICAL INTELLIGENCE

The IoT/AI managed sensor platform enables agile combat through enhanced situational awareness and reduced security risks for tactical warfighters. (Graphic by IoT/AI)

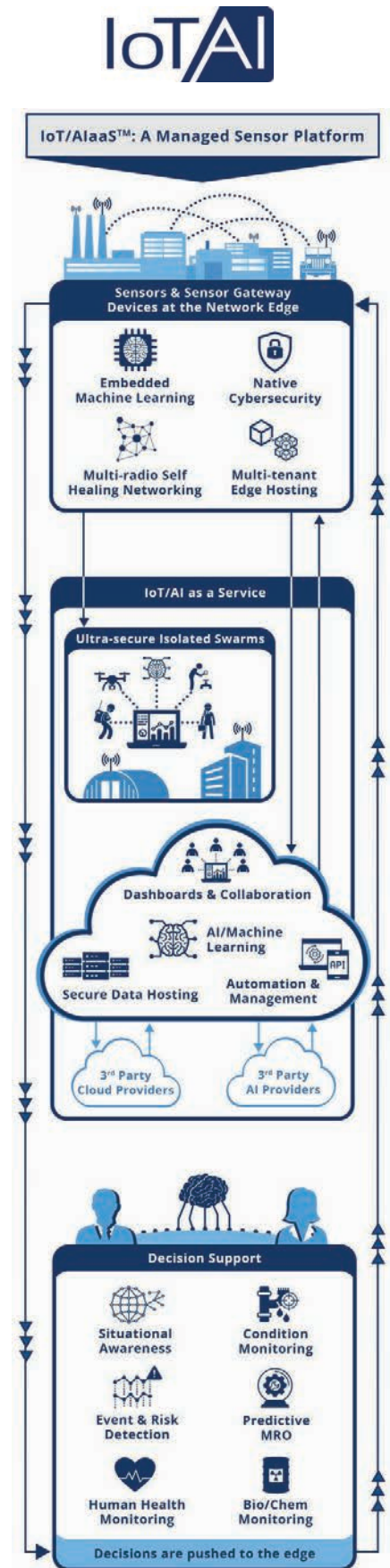

LYNQ TECHNOLOGIES INC.

LynQ Technologies provides a solution called LynQ, which is a lightweight, low-cost, radio frequency-quiet and jamming-resistant stand-alone location device. The device has a carabiner that improves situational awareness, squad vector logic and formation, and allows operators to tag, track and locate anyone or anything for miles like a sixth sense—no networks, apps, phones or maps required.

THE PEOPLE COMPASS

The LynQ device, sometimes called the “people compass,” allows groups of up to 12 people to find each other, at distances up to three miles, with no cellular service, no Wi-Fi, no maps and no network required. (Photo by LynQ Technologies Inc.)

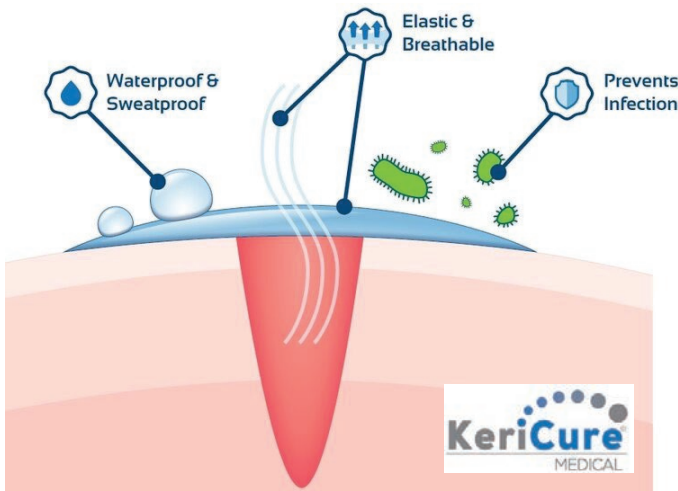

KERICURE INC.

KeriCure Inc. created nanopolymer-based skin- and wound-care products that provide immediate protection against bacteria, dirt and germs in a simple to use spray-on format. The nanopolymer technology affords durable, highly elastic wound barrier coverage over any size or shape wound. With the patented nanosilver polymer technology, KeriCure provides all-in-one wound care solutions that work.

THE BATTLE AGAINST INFECTION

KeriCure spray-on wound dressing products use nanopolymer technology to seal the wound, provide local pain relief and prevent infection. (Graphic courtesy of KeriCure Inc.)

MEI MICRO INC.

MEI Micro Inc. developed a proprietary 3D system micro-electro-mechanical systems (MEMS) fabrication platform that enables designs of high-performance, lowest-cost inertial sensors, as well as other MEMs sensors, that can be scaled to provide tactical, near-navigation and navigation performance while meeting crucial size, durability and cost requirements for low cost, size, weight and power.

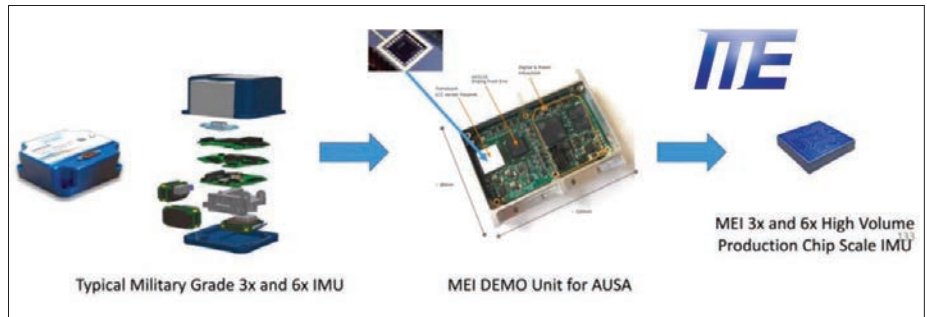

MICRO SOLUTIONS

MEI Micro is developing next-generation dual-use MEMs IMU sensor technology for assured position, navigation and timing (A-PNT) for inertial navigation systems. (Image by MEI Micro Inc.)

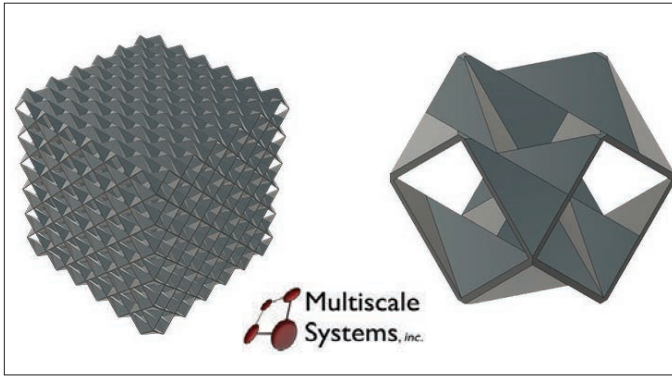

MULTISCALE SYSTEMS INC.

MultiScale Systems Inc. provides mechanical metamaterials that are directly applicable to the development of Soldier protective systems including Next Generation Combat Vehicles crush tubes, long-range missiles impact mitigation, load footprint reduction in aircraft, and mid-sized Joint Precision Airdrop System. Mechanical metamaterials are the next-generation class of structured materials with greater performance metrics on energy absorption, vibration control and reduced mass density.

THAT’S SO META

The MultiScale Systems MetaCORE product displays different properties when force is exerted—depending on which way it is turned. (Image by MultiScale Systems Inc.)

NOVAA LTD.

Novaa Ltd. developed an ultra-wideband antenna capability, enabling multiband operation across the C, X, Ku and Ka satellite communication bands. Based on commercial off-the-shelf components, the low-cost solution powers high bandwidth, multifunctional operations, replacing numerous separate antenna systems with a single, low-profile aperture conformal to operational platforms.

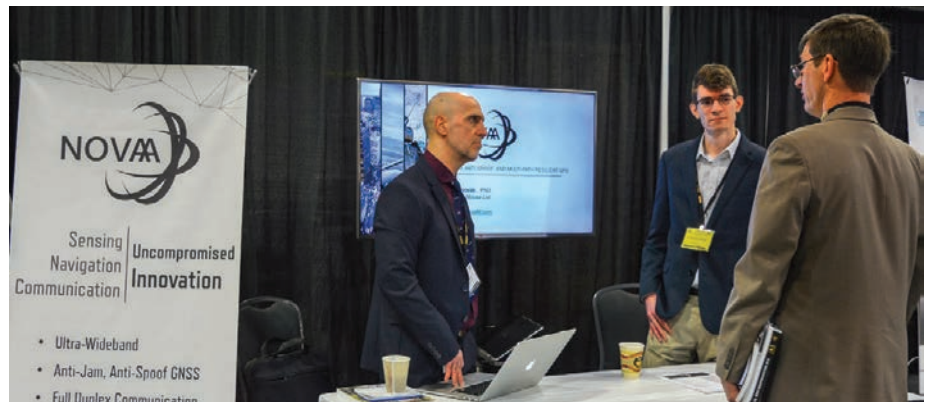

WIDE OPEN

Novaa’s ultra-wideband antenna allows for continuous operation across a 10:1 bandwidth on a single, low-profile aperture. (Photo by U.S. Army)



VITA INCLINATA TECHNOLOGIES

Vita Inclinata Technologies provides “Vita’s Load Stability System (LSS) Platform,” an active suspended load-stabilization device that addresses lack of payload stability in the global helicopter and crane marketplace. LSS senses the environment, fuses the data through Vita’s proprietary stabilization algorithm, then articulates high-performance electric ducted fans to counteract all motion the suspended hoist cable undergoes.

SPIN DOCTORS

Helicopter cargo likes to spin and sway in the wind. Vita Inclinata makes it stop. The company makes stabilizing attachments for small, medium and large loads. (Image by Vita Inclinata Technologies)

—JESS STILLMAN

AT HOME OR ON THE GO... SUBSCRIBE TODAY!

PRINT | DIGITAL | NEWS



[HTTPS://ASC.ARMY.MIL/WEB/SUBSCRIBE/](https://asc.army.mil/web/subscribe/)

ARMY AL&T IS AN AWARD WINNING PUBLICATION.



RYAN DEVINE

COMMAND/ORGANIZATION:

Product Manager for Force Sustainment Systems, Program Executive Office for Combat Support and Combat Service Support

TITLE: Assistant Product Manager for Shelter Systems

YEARS OF SERVICE IN WORKFORCE: 15

DAWIA CERTIFICATIONS:

Level III in program management and engineering

EDUCATION: M.S. in systems engineering and project management, Worcester Polytechnic Institute, Massachusetts; B.S. in engineering, Roger Williams University, Rhode Island

AWARDS: Detroit Federal Executive Board public service recognition, Project Manager Expeditionary Energy and Sustainment Systems Golden Shield, 10-Year Federal Career Service Award, Department of the Army Civilian Service Achievement Medal

ENGINEERING ACQUISITION

Ryan Devine is nothing if not an engineer. “I lean heavily towards the logical, analytical, left-brained way of thinking,” he said. A self-professed nerd and a natural problem-solver, he took an indirect path to the Army Acquisition Workforce (AAW), first working in research and development for the Army. It all began with his undergraduate engineering capstone project, when he was part of a team to design an automated inflatable bumper system to protect the hull of a high-speed Navy vessel during docking. “I seriously doubt that design was ever used,” he joked, “but it was a fascinating project.” At a career fair that spring, his fate was sealed.

“On a whim, I dropped a résumé at the NSRDEC [Natick Soldier Research Development and Engineering Center in Natick, Massachusetts, now the Combat Capabilities Development Command Soldier Center] table,” he said. The center, which had also sponsored his capstone project, called him for an interview. When he was eventually offered the job, “I immediately accepted,” Devine recalled. “Working for an organization as expansive as the Department of Defense, with responsibilities that could fluctuate and stay fresh and exciting, made the position really appealing.”

In fact, he was hooked. Applying his engineering skills and natural curiosity to solve military problems turned out to be a great fit for Devine. Twelve years later, as he prepared to take on his current position as assistant product manager (APM) for Shelter Systems within the Product Manager for Force Sustainment Systems (PM FSS), he was apprehensive about the change from research and development to the broader world of acquisition. “Probably the most important point in my career with the Army was when I accepted my current position,” he said. And despite his early concerns about the transition, “I’ve found my engineering background and way of thinking have been nothing but helpful in my acquisition career.”

Today, Devine is solving problems on a larger scale. His new home, PM FSS, falls under the Project Manager for Expeditionary Energy and Sustainment Systems, which is a part of the Program Executive Office for Combat Support and Combat Service Support (PEO CS&CSS). “FSS is responsible for a broad and diverse portfolio of equipment ranging from shelter systems to environmental control systems to tactical camouflage systems,” he explained. “As the APM for Shelter Systems, I manage specifically that portion of the portfolio: soft wall shelters, rigid wall shelters, vehicle-mounted shelters and a variety of products that can be integrated into shelters” (for example, insulation or electromagnetic spectrum shielding).

Shelter is one of the most basic human needs. And as engineers predictably do, Devine has begun looking for ways he can improve both the products themselves and the processes used to manage, procure and sustain them. “In the spirit of process improvement, I have created some tools for FSS personnel to use to make their jobs easier,” he said. One such tool, which he designed to streamline and partially automate the management of FSS fleet data, was recently adopted for more widespread use across PEO CS&CSS.

“In engineering, I could stay hyper focused on a single task,” he said. Working as an APM, however, he’s forced to take a more holistic view. “It was a gigantic shift in perspective,” he recalled. “I still think like an engineer, though. ... In my work now, these traits are still to my benefit.” Meticulous attention to detail, system-level thinking and process improvement are cornerstones of Devine’s approach to work. In fact, he was surprised and concerned by the lack of standardization in shelter products currently in use across the Army.

With a vast and easily accessible array of shelters available to Soldiers today, it’s no wonder. Soldiers need shelters. They can be purchased easily from a variety of sources. That makes total sense. The story gets more complicated, though, when a shelter needs maintenance, or when it needs to be transported to a new location. “What we in the PM world think of as ‘standard’—in other words, tested, safe, transportable and sustainable—is not necessarily the standard for everyone else,” Devine said.

“Soldiers across the Army have a wide variety of types of shelters, and it’s all by virtue of the way they were purchased,” he continued. “We need to reset and look at that issue from a total life cycle perspective.” If a unit procures a standard Army shelter, and it needs maintenance, then the Army offers sustainment support to get it fixed. “If they bought something nonstandard,” though, “they’re at the whim of the vendor, who may charge sizable fees for repairs, support, etc.”

So, how might an engineer approach this sort of problem? “That ... motivated me to spearhead a comprehensive strategy to improve standardization across Army shelters. Over the last year, I have developed the strategy and gained leadership endorsement on the approach.” He hopes

that as the strategy evolves, it demonstrates the value of standardization across this and other similar product types. An engineer through and through.

One difficulty Devine is still learning to tackle is a facet of human nature. “There is a tendency to resist change,” he said. “My biggest challenge is making process improvements that stick.” He has learned to start small. “Make moderate improvements. Start with small changes and demonstrate the benefit.”

What would he do if he were crowned king of acquisition for a day? “I’d want to make it easier for good ideas to flourish and see quicker and wider implementation,” he said. “This line of work is by nature bureaucratic and process-based, which can sometimes stifle good ideas.” Given the chance, he would change that paradigm. “I think it would have to start with greater access. People at the working level would need access to leaders and decision-makers. If that access were there, and the ideas were good, I think leaders would listen and be willing to give new things a try.” He shares similar advice with his peers in acquisition. “Most often, I suggest that there is nothing to be gained in government by withholding information from your colleagues. Denying access

to information creates lasting impediments to productivity and efficiency that can be difficult to overcome.”

If Devine sounds like a man who has embraced his “nerd” status, he won’t disagree with you. “The most important lesson I’ve learned—both on and off the job—is that it’s OK to be unique,” he said. “We are all different in how we absorb, process and dispense information. ... When a person comes to appreciate and embrace those differences instead of diminishing them, he or she really begins to flourish in both personal and professional life.”

Embracing a diversity of viewpoints, personalities and skills, Devine relishes his work. “This position is truly satisfying because FSS has the singular focus of improving a Soldier’s daily life,” he said. “The products we manage enable safe, seamless, effective execution while on-mission; and off-mission, they improve health, welfare and quality of life. Products like ours often go unnoticed and underappreciated, but the positive impact they can have on a Soldier’s life and duties is massive.”

—ELLEN SUMMEY



LUNCH WITH THE BOSS

Ryan Devine, seventh from left, was among a group of Army civilian employees selected to have lunch with then-Secretary of the Army Mark T. Esper during his visit to PM FSS on March 15, 2019. (Photo by Staff Sgt. Brandy Nicole Mejia)

AUSTERE CARE

NETCCN is meant to provide military medical care to the austere environments likely to be found during multidomain operations, like these U.S. Marines found in August 2019 during an exercise in Kuwait. (Photo by Cpl. Miguel A. Rosales, 1st Marine Division)



DIALING UP CRITICAL CARE

NETCCN promises to bring high-quality care to patients, digitally.

by Ramin A. Khalili

If you know Matthew Quinn, the new science director at the U.S. Army Medical Research and Development Command's (USAMRDC) Telemedicine and Advanced Technology Research Center (TATRC), then you know that technology—emerging concepts, practical uses and all of its endless possibilities—is in his blood. A former Army officer and engineer turned Silicon Valley executive, Quinn has, in many ways, spent his entire professional life looking for the so-called “next big thing” in technology. Now, upon his return to federal service, he may have just found it.

“This is a really powerful project,” said Quinn of TATRC’s newest brainchild, the National Emergency Telecritical Care Network (NETCCN)—the premise of which originated in part with Col. Jeremy Pamplin, the center’s director and a critical care physician. “There is an immediate need for these kinds of capabilities.”









In simple terms, NETCCN sits at the intersection of the kind of military medical care required to support the austere environments likely to be found during multidomain operations and the rapid growth of digital health technologies and telehealth opportunities that are becoming pervasive in the civilian world. In essence, by applying the vast technical and clinical knowledge found in both realms, the center hopes to build NETCCN into a new digital health system that will revolutionize overall care for patients during disasters and, possibly, more broadly as

well. In more detailed terms, NETCCN is a cloud-based, low-resource, stand-alone health information management system with the capability of creating innumerable “virtual critical care wards” to bring high-quality care capability—via current handheld mobile devices—to nearly every bedside in the country.

It is, in many ways, a substantial undertaking.

“It’s not just a technology thing,” said Quinn, the former tech-sector executive now coordinating NETCCN’s development from his home office during the pandemic. “This is clinicians working with technologists on a brand new care model.”

That Quinn would be working from home (like many of his colleagues, of course) during the coronavirus outbreak is somewhat ironic given the catalyst for NETCCN is the novel coronavirus itself. Disasters of any kind notably stress health care infrastructure and staff, as there are simply not enough qualified clinicians to provide care during large-scale emergencies. And while many health systems across the country already have existing digital models of care for smaller, more localized emergencies (think telehealth consultations for victims of car crashes or stroke), the team at TATRC initiated the NETCCN effort by asking those same health systems, along with clinicians affiliated with the Society of Critical Care Medicine (SCCM), how they would refine those models for the current pandemic.

LOE		Phase 1			
COVID-19	 <p>Area 0: Digital health at home Personal health monitoring identifies possible infection.</p>	 <p>Area 1: Virtual clinic Patient might be sick – engages VH.</p>	 <p>Area 2: Virtual hospital ward Patient needs monitoring and is admitted to a virtual ward, monitored using mobile device, wearables and medical monitoring devices if available.</p>	 <p>Area 3: Virtual intensive care unit Patient needs resuscitation – supported by TCC using remote monitoring, remote control and autonomous systems.</p>	 <p>Area 4: Virtual operating rooms Patient needs a procedure – supported by TCC using AR, robotics, etc.</p>
	OPERATIONAL MEDICINE	 <p>Role 0: Digital health on mission Soldier status monitoring identifies optimal, ready, degraded, casualty.</p>	 <p>Role 1: Virtual clinic in a "foxhole" Soldier is not optimal – system nudges with decision support or recommendations, if degraded or a casualty, system engages VH.</p>	 <p>Role 2: Virtual hospital ward at tent Soldier needs monitoring and is admitted to virtual ward, monitored using mobile device, wearables, medical monitoring devices if available.</p>	 <p>Role 3: Virtual intensive care unit Soldier needs resuscitation and gets evacuated or, if not possible, is managed in PFC – both are supported by TCC using remote monitoring, remote control and autonomous systems.</p>

KEY	
AR: Augmented reality	TCC: Telecritical care
LOE: Line of effort	VH: Virtual health
PFC: Prolonged field care	

OH, THE POSSIBILITIES

There are many potential uses and applications for NETCCN in the military operational and civilian worlds, but the system will require more work before implementation. (Graphic courtesy of TATRC)

That’s when TATRC knew they were onto something.

ALWAYS ON CALL

“You can get extra beds and you can maybe get extra ventilators,” said Quinn, “but what you just can’t surge quickly enough is the expertise required to manage these complex patients.” In other words,

you can’t just order new nurses or cardiologists from a catalog. But what if you could access them online when needed?

According to Quinn, many of those aforementioned health systems told TATRC they were already in the process of refining their own digital models to be deployed quickly and to work as much as possible

in both bandwidth-constrained areas and with current mobile devices. He’s quick to point out that rural America has been dealing with these kinds of supply-and-demand issues for years; problems solved in large part thanks to these same kinds of digital telehealth solutions. What sets NETCCN apart from standard telehealth care, then, is that it will operate

Phase 2

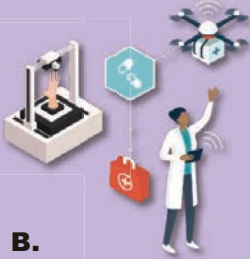
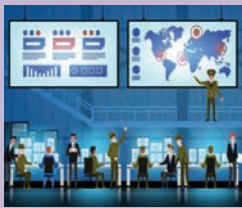
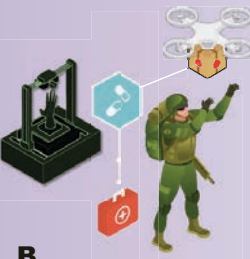
**A.
Synchronization
& workflow****B.
Medical “stuff”
—medication,
supply, blood,
delivery &
fabrication****A.
Synchronization
& workflow****B.
Medical “stuff”
—medication,
supply, blood,
delivery &
fabrication**

from point-to-point (“from anywhere to anywhere,” in Pamplin’s words) as opposed to the traditional “hub-and-spoke” model, which is dependent on a single outlet (like a hospital or university) broadcasting instruction to a series of single users.

“We anticipate that there’s going to be a need for doing this community-wide,

“It’s not building stuff from scratch. In a matter of 60 to 90 days, we’re going to be out there with these tools.”

and then even statewide and regionally and nationally,” said Quinn, noting a few recent pandemic-inspired examples. “For example, when the rest of the country needed New York’s help or the Northeast’s help, how could we have facilitated that [with NETCCN]? And then how could we have facilitated the parts of the country that weren’t afflicted [at the time] when they needed it?” The idea is to surge medical specialists when needed, with no travel required.

GAINING TRACTION

But just as with any great idea in the military medical world, the acquisition process is the critical driver of success. For the NETCCN project, that’s where Jeanette Little comes in.

“My job is to make it happen,” said Little, a lab leader at TATRC whose office is located at Fort Gordon in Augusta, Georgia—the home of Army Cyber Command. “We do all the rubber-meets-the-road stuff.”

That proverbial road, however, was always designed to be a short one. Adhering to an incredibly accelerated timeline, TATRC sent out a request for proposals for NETCCN in mid-April, with hopes of having the entire network up and running by late October. A process that started with 600 participants on the initial proposer’s call ultimately led to 79 proposals. “We were hoping to get maybe 30,” said Little.

Currently, the center is winnowing down that group from nine teams to six teams; ultimately planning to settle on three final teams that will then be asked to develop the network in a collaborative fashion. “I’ve never seen so much scientific rigor put into an acquisitions process,” she said.

Indeed, part of the reason such a fast-moving effort is possible can be attributed to the center’s reliance on the USAMRDC partnership with the Medical Technology Enterprise Consortium (MTEC). A nonprofit corporation comprised of hundreds of private, academic and not-for-profit organizations, MTEC is designed to accelerate the translation of medical technologies into solutions focusing chiefly on the health of U.S. military personnel and veterans. An integral part of MTEC’s partnership with DOD—and the key mechanism allowing NETCCN to progress as quickly as it has—rests within its use of the other-transaction authority (OTA), a powerful tool that allows MTEC to operate a solicitation process in a more transparent and collaborative manner, tearing down traditional acquisition barriers restricting government-industry interactions.) It is perhaps the MTEC brand name that helped bring such headliners as Microsoft, T-Mobile, Emory Healthcare and the University of Pittsburgh (among others) to the table as part of various teaming arrangements for NETCCN. “We are very deliberate because we need a working solution to help



LONG-DISTANCE SUPPORT

NETCCN is being developed with the goal of dramatically improving care for warfighters in austere environments, like these deployed Soldiers who participated in a mass casualty exercise in September 2019 at Al Asad Airbase, Iraq. (Photo by Sgt. 1st Class Tracy L. Korff, 641st Regional Support Group)



COVER YOUR BUDDY

NETCCN was originally developed to help aid care for COVID-19 patients nationwide, with an eye toward helping both the warfighter and the larger civilian population during disaster relief efforts in the future. Here, Navy Lt. Tiffany Bradley participates in fit testing for an N95 respirator and survival mask at Naval Hospital Okinawa, Japan, on March 27. (Photo by 1st Lt. Tori Sharpe, U.S. Marine Corps)

with all kinds of health-related issues, not the least of which is the current pandemic,” said Little.

“This isn’t a science experiment,” Quin added. “It’s not building stuff from scratch. In a matter of 60 to 90 days, we’re going to be out there with these tools.”

Beyond the pandemic—and outside of other practical applications on the home front such as large-scale disaster situations—there can be no doubt the NETCCN would clearly translate well to the future battlefield; providing increased Soldier care in austere environments; and particularly with regard to the current posture of DOD as it relates to multidomain operations. Indeed, the NETCCN team is currently working on a slew of models designed to project how, exactly, the network would be used in dense urban environments and on ships. Given the network’s “anywhere to anywhere” capabilities, the capacity to empower, for instance, medics to work far beyond the scope of their license on complicated care issues with support from literally any echelon of care would be a game-changer for force health and resilience.

For right now, however, more work needs to be done. Data collection (as in the analysis of data culled from the testing of prototype NETCCN platforms and then enabling contribution of data to a “data commons” repository) remains a challenge in such a fast-paced project (such efforts would be “showstoppers” in any other arena at any other time, admits Quinn), and yet that hasn’t stopped the NETCCN’s progress in the least. In fact, TATRC officials have already set their sights on using said data for developing future analytical models and possibly for artificial intelligence purposes.

“There’s value in what we’re doing,” said Quinn. “Not only for the current crisis, but for future emergencies as well.”

For more information about TATRC, go to <https://www.tatrc.org/about/>. For more information about the USAMRDC, go to <https://mrdc.amedd.army.mil/>.

RAMIN A. KHALILI is a writer with the USAMRDC Public Affairs Office. Before assuming his current role, he spent five years as the knowledge manager for the USAMRDC’s Combat Casualty Care Research Program. During his previous work as a broadcast journalist, he earned an Associated Press Award for his work in Phoenix, Arizona, before serving as chief NASA correspondent for CBS in Orlando, Florida. He holds a B.A. in communications from Penn State University.

REALIGNING FOR A REASON

| PEO C3T transforms to advance Army network modernization.

by Karen Danfelt

This summer, the Program Executive Office for Command, Control and Communications – Tactical (PEO C3T) transformed its organizational structure to meet cross-functional and rapid acquisition requirements driving the Army’s network modernization strategy. At the center of the realignment is a new project office that will direct linkage and coordination between the Army network program offices and the Army’s Network Cross-Functional Team to advance the network modernization strategy’s lines of effort.

REALIGNING FOR A REASON

Whether you call it a reorganization, restructuring, re-engineering or something else, making a significant change to an organization’s layout is a big decision that can impact its people, operations and customers. Before redrawing the organizational chart, senior leaders must consider *why* they are doing it—what factors drive the need to change the organization—and whether these are right for the organization’s future.

The PEO C3T senior leadership began contemplating an organizational realignment in late 2019. A perfect storm of changes in the Army’s program and acquisition strategies inspired leaders to take a fresh look at how the organization’s resources were matched to key programs and stakeholders.

There were three key reasons for realignment.

1. Stand-up of Army Futures Command.

The stand-up of U.S. Army Futures Command (AFC) in July 2018 prioritized Army modernization efforts and enabled horizontal integration across priorities. The command has been instrumental in aligning science and technology (S&T) and industry innovation to high-priority programs, including the network.

In order to support AFC efforts, program management offices have adjusted and leveraged acquisition practices and authorities not only to procure faster, but also to access and capitalize on technology being developed by industry, particularly small businesses and nontraditional defense companies.

“AFC proposed a real shake-up in the acquisition life cycle as we had known it, which was a major factor in our decision to restructure,” said Joseph Welch, deputy program executive officer for C3T. “We knew we needed to make changes to our organization so we could appropriately manage a faster transition of technology to programs of record.”

2. Establishment of the Network Cross-Functional Team and network lines of effort.

With network modernization identified as one of the Army’s top priorities, the PEO quickly formed a close bond with the Network Cross-Functional Team, which AFC charged with informing and driving capability requirements through prototyping,

A perfect storm of changes in the Army's program and acquisition strategies inspired leaders to take a fresh look at how the organization's resources were matched to key programs and stakeholders.



SYMBOLS OF PROGRESS

The triangular shape of the PL I2S logo symbolizes the synergy of the R&D, acquisition and modernization communities, with PL I2S as the central integrator. The interlocking bars illustrate interoperability and integration. The gold cyclic arrows represent the continuous evolution of development in the Army's DevOps model. (Image by PEO C3T Public Affairs)

experimentation and technical demonstrations while coordinating network-related research and development (R&D) and S&T.

Together, the PEO and Network Cross-Functional Team developed a network acquisition road map guided by four lines of effort:

Unified network transport—Ensure network transport in a contested environment and dominate adversaries in both cyberspace and the electromagnetic spectrum. Network transport capabilities allow data to be received and sent over radio and satellite communications networks, similar to the way commercial cellphone technology works.

Common operating environment—Enable distributed mission command and rapid decision-making by providing a simple, intuitive, single common operating picture through a single mission command suite.

Interoperability—Ensure joint network interoperability and coalition accessibility with all unified action partners.

Command post mobility and survivability—Deliver mobile, survivable command posts in a dynamic, lethal combat environment. The effort integrates Army tactical network

communications and application capabilities onto vehicle platforms that will provide commanders greater mobility and survivability by reducing electronic signature and complexity in the setup of command posts.

The road map categorizes all network acquisitions and modernization activities by capability sets that align to the Army's network strategy. Successful integration across the lines of effort to deliver each capability set requires the PEO's program offices to be in lockstep with the Network Cross-Functional Team as well as the R&D and S&T communities.

3. Renewed focus on alignment and transition of S&T.

Fiscal year 2020 marked the first time that research, development, test and evaluation funding was available to support capability set development. Also called 6.4 funding, it is specifically for prototypes of technologies that show promise early in the acquisition process. Although the program office manages the funding, the Network Cross-Functional Team executes the resources to experiment with prototypes from industry and S&T efforts. This experimentation informs capability-set network design; if successful, the capabilities transition to programs of record for management. In 2020, the Network Cross-Functional Team

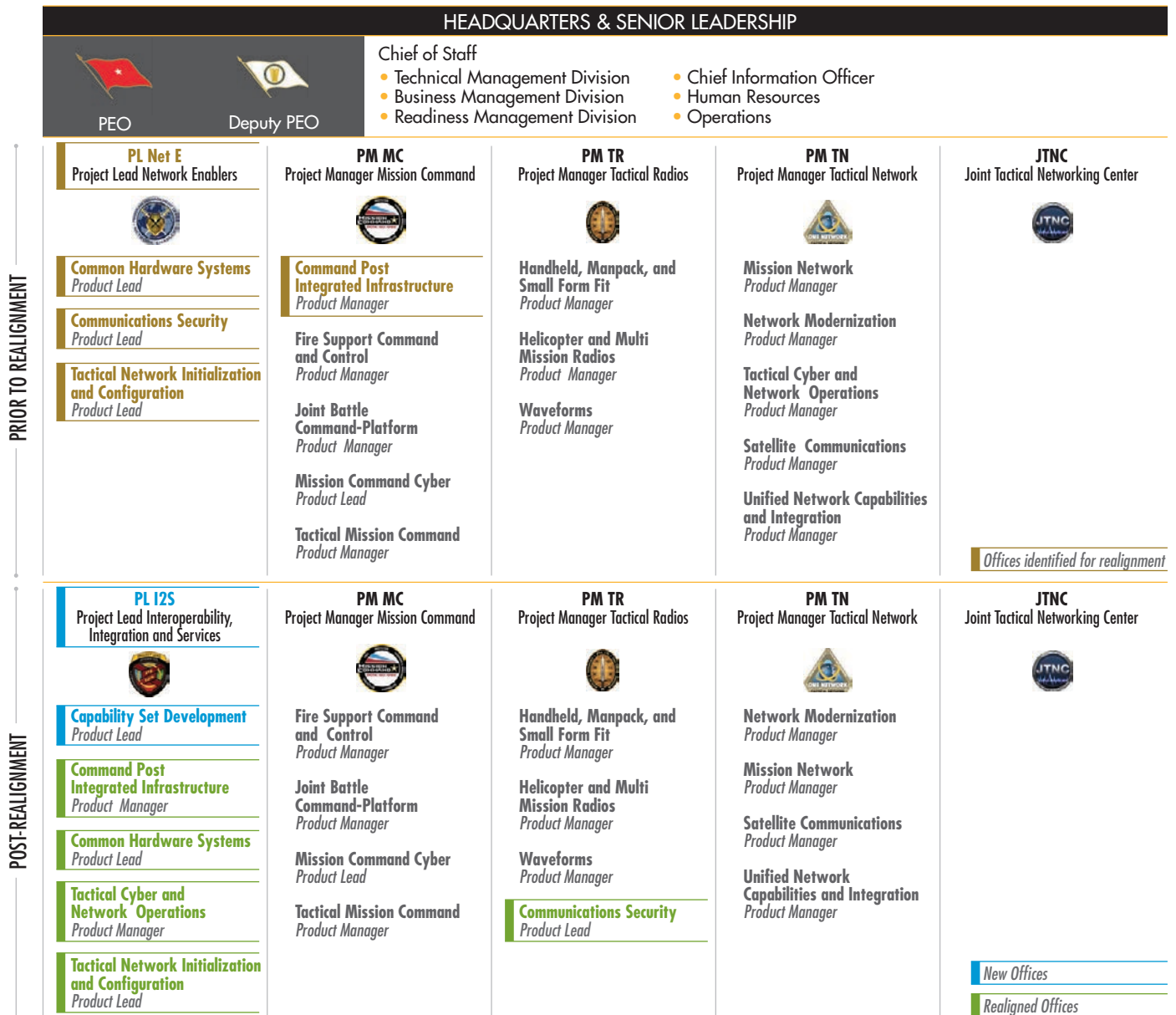

REALIGNMENT WITH A RATIONALE

Several PEO C3T project and product management offices have realigned to form the Project Lead for Interoperability, Integration and Services, which will serve as a single focal point for coordination with the Network Cross-Functional Team to advance Army modernization priorities. (Graphic by PEO C3T Public Affairs)



INTEGRATED NETWORK

The ITN provides smaller, lighter, faster and more flexible communications systems with multiple connectivity options primarily at battalion and below. Paratroopers with the 82nd Airborne Division provided the critical feedback necessary for the Army to make its final ITN design decisions for Capability Set 21. (Photo by Justin Eimers, PEO C3T Public Affairs)

identified eight Army-developed and six industry-based S&T efforts to use its prototype budget to develop advanced capabilities, ranging from spectrum obfuscation for signal security to mobile command posts with increased resilience and data distribution. With the volume of experimentation, resources to be managed and potential transition plans to be put in place, the PEO identified the need for a central project management office. Leaders determined that this office would serve as a financial steward for the new funding stream and monitor the prototype experimentation-demonstration-evaluation

process to ensure a smooth transition to programs of record.

With these reasons in mind, “all signs pointed us toward a strategic organizational realignment,” said Welch.

TRANSFORMING FOR MODERNIZATION

Looking at its organizational structure, PEO leadership saw an opportunity to create an office that would synchronize efforts across the entire C3T portfolio, and connect with points outside the portfolio that are enabled by the Army network,

such as Future Vertical Lift, the PEO for Intelligence, Electronic Warfare and Sensors and the Next-Generation Combat Vehicle Cross-Functional Team, among others. This new office will be PEO C3T’s primary interface with the Network Cross-Functional Team and will manage critical network modernization programs, including Capability Set 23, as well as the 6.4 funding stream.

Called the Project Lead for Interoperability, Integration and Services (PL I2S), the new office will play a key role in coordinating between the Army’s program offices that deliver tactical network capability and the Network Cross-Functional Team, while focusing on capability development that will support network interoperability, a major line of effort within the Army’s network modernization strategy.

Additionally, the new office will oversee the Army’s prototype budget for tactical network modernization projects, including the annual planning and execution of technology demonstrations, as well as Soldier touch-point events to capture user feedback.

“Our mission is to deliver integrated tactical network capabilities to the Soldier that make their tasks easier, faster and more intuitive.”

		LOE 1 Unified Network Transport	LOE 2 Common Operating Environment	LOE 3 Interoperability	LOE 4 Command Post Mobility & Survivability
	CHS	✓	✓	✓	✓
	CPI2	✓			✓
	CSD	✓	✓	✓	✓
	TCNO	✓		✓	
	TNIC	✓	✓	✓	

KEY	
LOE: Line of effort	TCNO: Tactical cyber and network operations
CHS: Common hardware systems	TNIC: Tactical network initialization and configuration
CPI2: Command post integrated infrastructure	
CSD: Capability set development	

COVERING THE BASES

The new Project Lead for Interoperability, Integration and Services combines offices that, with the products and programs they support, touch every one of the four lines of effort in the Army network modernization strategy. (Graphic by PEO C3T Public Affairs)

Several PEO C3T project and product management offices have realigned to form PL I2S, including the Product Manager for Command Post Integrated Infrastructure, realigned from the Project Manager for Mission Command, and the Product Manager for Tactical Cyber and Network Operations, moving from the Project Manager for Tactical Network.

They are joined by one new office, the Product Lead for Capability Set Development (PDL CSD), which formally assigns staff and resources to manage technical integration in support of the Army’s desire to introduce significant new network capabilities every two years through capability sets—groupings of tactical network technologies that infuse the latest commercial solutions and Soldier feedback with each iteration. The new product office will work across the PEO’s project management offices to promote

synergy in planning, execution and risk management, and will serve as a touch point for systems engineering, design and testing. PDL CSD is currently focused on Capability Set 23 experimentation planning in preparation for a preliminary design review in spring 2021.

Preceding the stand-up of PL I2S was the stand-down of the Project Lead for Network Enablers (PL Net E). Joining PL I2S from PL Net E are the Product Leads for Common Hardware Systems, the Army’s preferred source for procurement of commercial information technology hardware, and Tactical Network Initialization and Configuration, which delivers critical capabilities that ensure interoperability of digital systems and communication assets for current and future network architectures.

This combination of offices and the products and programs they support touches every line of effort in the network modernization strategy. “The stand-up of PL I2S is an opportunity to work hand in hand with developers, users and the Network Cross-Functional Team to achieve our mutual goal of delivering unmatched tactical network capabilities to the Army and our allies,” said Brig. Gen. Robert M. Collins, program executive officer for C3T. “The I2S team will ensure we have a single focal point with the Network [Cross-Functional Team] as we work toward not just an integrated tactical network within a tactical formation, but also how it connects back to the enterprise.”

Completing the organizational realignment is the Product Lead for Communications Security, which is moving from PL Net E to the Project Manager for Tactical Radios. The move better aligns the acquisition functions and the technical experts that provide radio key and cryptographic capability with the communication programs they support.

PARTNERING TO MODERNIZE THE NETWORK

The PEO’s new organizational structure became effective on July 10 with a ceremony to stand down PL Net E and stand up PL I2S. Since then, the new team has continued supporting current programs and warfighter exercises while actively engaging the Network Cross-Functional Team and other stakeholders on the development of Capability Set 23.

“Our mission is to deliver integrated tactical network capabilities to the Soldier that make their tasks easier, faster and more intuitive,” said J. Ward Roberts, who was selected to lead the stand-up and serve as the office’s first project lead.

Roberts sees PL I2S as a partner, integrator and facilitator. “By virtue of the products we support, we have a bird’s-eye view of the tactical network and all its stakeholders. If we can help make connections and facilitate conversations taking place, it will make it easier for the Army to deliver these capabilities; make them faster, cheaper and easier to use. That is our value proposition and how we will do business.”

Network Cross-Functional Team leadership agrees that, with its focus on interoperability, PL I2S has a critical role in ensuring capability set delivery. “The stand-up of this new project office clearly demonstrates the PEO’s commitment and alignment to our shared network modernization objectives,” said the Network Cross-Functional Team director, Maj. Gen. Peter A. Gallagher. “I look forward to teaming with the new PL to effectively execute



STRATEGIC MOVE

J. Ward Roberts, right, the Project Lead for Interoperability, Integration and Services, receives the new organization’s colors from Brig. Gen. Robert M. Collins, program executive officer for Command, Control and Communications – Tactical, during a ceremony July 10 at the Mallette Training Facility on Aberdeen Proving Ground, Maryland. (Photo by Ryan Myers, PEO C3T)

our prototyping efforts, which are critical to informing capability set design goals and focused on ensuring the effective transition of S&T projects into programs of record. This new PL’s role is even more critical as we move into future capability sets and focus on platform integration of network requirements across all of the Army’s modernization priorities.”

For more information, go to <http://peoc3t.army.mil/c3t/>; or contact the PEO C3T Public Affairs Office at 443-395-6489 or usarmy.APG.peo-c3t.mbx.pao-peoc3t@mail.mil.

KAREN DANFELT is a senior communication strategist for Booz Allen Hamilton supporting the Project Lead for Interoperability, Integration and Services. She has an MBA from Mount St. Mary’s University and a B.A. in communication (concentration in public relations) from the University of Maryland, College Park. She is a certified Project Management Professional and LaMarsh Global Change Agent.

A RISKY BUSINESS

Acquisition decisions are inherently risky; we must learn to manage risk like a successful gambler.

by Jason Martin

EXPLOSIVE COSTS

Collecting data comes with a cost. If the cost is too high, that may limit the quantity of data being collected, which in turn limits what can be learned from the data in question. For a test involving \$500,000 missiles, the costs would mount quickly and testing would likely be limited. (Photo by Jason Cutshaw, U.S. Army Space and Missile Defense Command)

Much like a high-stakes gambler deciding whether to raise, check or fold, the acquisition process for military systems is a series of high-stakes decisions in which we commit more resources for further development (raise) or stop funding an effort (fold). There is seldom an option to delay a decision with no cost (check). Ultimately, Soldiers' lives are at stake. Successful gamblers understand the risks they are taking and know how to consider these risks when making decisions.

Acquisition leaders emphasize that the Army needs to accept more risk when making decisions, and, for acquisition professionals, comfort with risk comes from understanding it. Understanding risk allows us to make appropriately risk-aware decisions as individuals and as an organization. We must make decisions the way successful gamblers do—with a clear understanding of risk. Throughout the acquisition process, how can decision-makers best understand the risks they are taking and make risk-aware decisions? What kind of information must decision-makers insist on being provided?

To manage risk when making a decision, Army acquisition professionals often collect data through testing or experimentation (for the rest of the article, simply called testing). We then analyze the data to create the information needed to support the decision. The cost of collecting data often limits the data we can collect; therefore, there are limitations in what we can learn from the data. For example, when testing \$500,000 missiles, the costs of missiles, test range time and personnel can quickly become too great, so the number of missiles that can be tested is limited. When data is analyzed appropriately, an important way the data limitations will show up is in the form of uncertainty in our conclusions. Understanding this helps us make risk-aware decisions.

Using the design of experiments to plan tests allows us to use expert assumptions to determine a sufficient but not excessive number of test events to achieve acceptable levels of risk.

We collect data for many purposes and from many sources to inform decisions throughout the acquisition process. Examples include performing basic science experiments to identify technologies worthy of further investment, running computer models to determine the best design characteristics, using flight simulators to assess pilot-vehicle interfaces and range testing to support vendor selection or a fielding decision. In many cases, we test to understand how changes in the inputs to a process affect some response, the end result that is being measured. Though the example below is of a fielding decision, the points made in this article apply any time we attempt to understand how inputs affect a response.

A RISKY BET?

Consider a system that warns aircraft pilots of incoming missiles. A program manager (PM) must decide whether to field a new version of software or continue with the current version.

In this simple case there is only one input, the software version (current or new), but there could be many more. To determine whether the new software is “better” and should be fielded, the response being measured is whether the system successfully detects a simulated missile (success or failure). The PM will consider the new software worthy of fielding if its probability of successfully detecting a missile is at least 5 percent greater than for the current software. The PM has budgeted 20 test events for each software version.

During the test, the new software is successful in 18 of 20 events (90 percent success rate), and the current software is successful in 16 of 20 events (80 percent success rate). How should the PM decide whether to field the new software? One common approach is to select the software with the greater success rate—in this case the new software. But is this a good decision? Although the new software performed 10 percent better, do test results provide sufficient evidence that the new software really is better? Is it possible to get these results even if the new software is equivalent or even worse? If so, how likely is that to happen? To make a risk-aware decision, the PM must be able to answer these questions. Otherwise, the PM is acting like an unskilled gambler. These questions and others can be answered using appropriate statistical analysis methods.

The plot in Figure 1 is a result of statistical analysis of the test data described above (more specifically, logistic regression was used for analysis). Understanding what the plot tells us is critical to making a risk-aware decision.

FIGURE 1

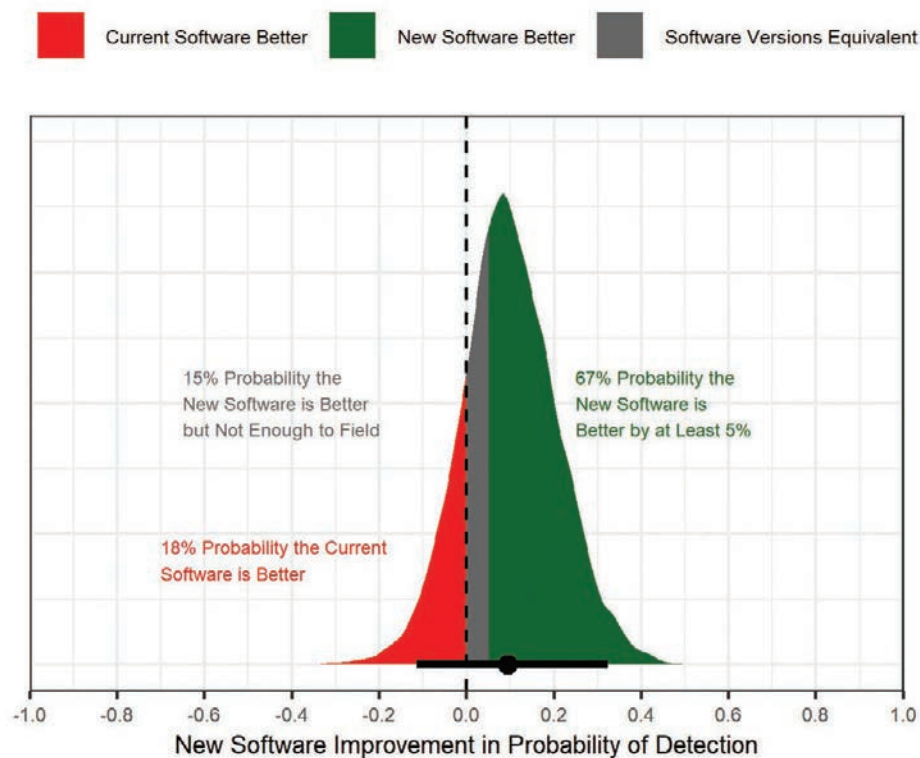

PROBABLE CAUSE

Statistical analysis of the test data yields this result, which demonstrates the probability of detection. Understanding the meaning of the data is critical to making a risk-aware decision. (Image by the author)

Notice that the peak of the distribution is very close to 10 percent and is designated by the black dot at the bottom of the distribution. This represents our best estimate of the improvement when using the new software, and should not be a surprise since the new software had a 10 percent greater success rate during testing.

However, because we have limited data, there is uncertainty about the true improvement that the new software would provide in the many events that would occur over the lifetime of a fielded system.

This uncertainty is represented by the black line at the bottom of the distribution, which indicates the range of values 95 percent likely to contain the actual (and unknown) improvement. The line ranges from -0.07 to 0.28, and this tells us that it is reasonable to conclude the new software results in an improvement of -7 percent (the new software is 7 percent less likely to detect a missile, and is inferior) to 28 percent (the new software is 28 percent more likely to detect a missile, and is better). Although the PM would prefer a definitive answer to the question “Is the new software better?”, it isn’t possible with the data available. To make a risk-aware

decision, the PM must recognize this when deciding what to do.

The colored regions help us understand the risk we’re taking when making a decision. The green area contains 67 percent of the area in the distribution, and this tells us there is a 67 percent chance that the new software is better than the current software. We can also see that there is a 15 percent chance the two versions are equivalent (new software better but by less than 5 percent per the PM), and an 18 percent chance that the new software is actually worse in spite of the fact that it performed better in testing.

By understanding the information described above, the PM can make a risk-aware fielding decision by weighing the potential for fielding a better software against the risk of spending resources to field equivalent or inferior software. At a high level, there are three options:

- Field the new software with a 67 percent chance that it improves probability of detection by at least 5 percent and some potential for at least 28 percent improvement. The risk is that the PM will spend possibly substantial resources to field the software while accepting a 33 percent chance that Soldiers are receiving software that either degrades or does not sufficiently improve performance.
- Continue with the currently fielded software, save the cost of fielding and accept a 67 percent risk that Soldiers are not receiving improved software.
- Spend time and other resources to collect more data to more accurately understand the actual improvement provided by the new software.

The actual decision the PM would make could also depend on other factors and isn’t important for now. The point is that by

We collect data for many purposes and from many sources to inform decisions throughout the acquisition process.

quantifying the risk of fielding an inferior system or failing to field an improvement, the PM can weigh these risks against the cost of fielding, the cost of collecting additional data and other factors. The PM can also clearly communicate these risks to other stakeholders so that everyone understands the risks being taken. It is important to note that a common understanding of risk can significantly improve the ability of an organization to be more risk aware. This includes enabling an organization to constructively learn from failures instead of punishing them.

The example above shows one of many ways statistical analysis can be used to communicate uncertainty and risk. Using statistical analysis to quantify and understand risk clearly allows for a more risk-aware decision than simply choosing the new software because it had a 10 percent greater success rate during testing. While truly understanding risk can make a decision more difficult, even gut-wrenching, we owe it to our Soldiers to understand the risks involved when making decisions that affect them.

NOT ALL DATA IS CREATED EQUAL

While the focus of this article is on the importance of considering risk when making a decision, it is necessary to note the importance of the way we determine

how much and what specific data to collect.

In the example above, the test included 20 events for each software version because that is what the PM had budgeted. This number of events arguably resulted in more risk than the PM desired when making the fielding decision. Budgeting for testing is frequently done by looking at what has been done in the past, just doing what seems reasonable or affordable, or arguing to further reduce testing until someone refuses. By leveraging system expert knowledge, statistical methods known as “design of experiments” allow us to control the uncertainty we expect in

our conclusions even before resources are spent to execute a test.

These methods help us to manage risk and resources by allowing us to rigorously trade among the cost of a test, the amount of information we gain from a test, and the accuracy that we can achieve when doing statistical analysis on data.

In short, using the design of experiments to plan tests allows us to use expert assumptions to determine a sufficient but not excessive number of test events to achieve acceptable levels of risk. In those situations where resources prevent us from limiting risk as much as desired, we can at least understand the risks we’re taking before



ALL ABOUT METRICS

Decisions throughout the acquisition process are informed by data collected from many sources. Often, tests are designed to help us understand how changes in the inputs will affect some response, the end result that is being measured. (Image by Getty Images)



A GAMBLER'S APPROACH

We should take a cue from successful gamblers, who make decisions with a clear understanding of the risks involved, rather than attempting to avoid risk entirely. (Image by Getty Images/Simon Webb and Duncan Nicholls)

resources are committed. Though used for decades by some to very successfully understand complex military systems, widespread use of design of experiments and statistical analysis across the DOD in all phases of research, development and fielding would provide substantial benefits. Methods and software tools are available that allow us to collect data and perform analysis to answer questions about even our most complex military systems.

CONCLUSION

Taking risks that ultimately impact the effectiveness and safety of our Soldiers is inherent in the acquisition process. By using design of experiments to plan tests and statistical methods to analyze the resulting data, we can most efficiently utilize resources to provide decision makers with a true understanding of risk. The costs of continuing to fund an effort (e.g. a specific research effort, system upgrade or program) can be substantial in terms of time and taxpayer dollars; ending an effort can result in missed opportunities to

make Soldiers safer or more effective. To successfully make such high-stakes decisions, decision-makers must insist that information provided to them is based on appropriate data and that the information quantifies risk. Only by doing so can they make risk-aware decisions in the best interest of our Soldiers.

For more information on applying design of experiments and statistical analysis to military systems, go to <https://testscience.org/design-of-experiments>.

JASON MARTIN has been the test design and analysis lead for nine years at the U.S. Army Combat Capabilities Development Command Aviation & Missile Center, Test and Evaluation Division. He has an M.S. in statistics from Texas A&M University and an MBA and a B.S. in mechanical engineering, both from Auburn University. He is Level III certified in test and evaluation and in engineering.

While truly understanding risk can make a decision more difficult, even gut-wrenching, we owe it to our Soldiers to understand the risks involved when making decisions that affect them.

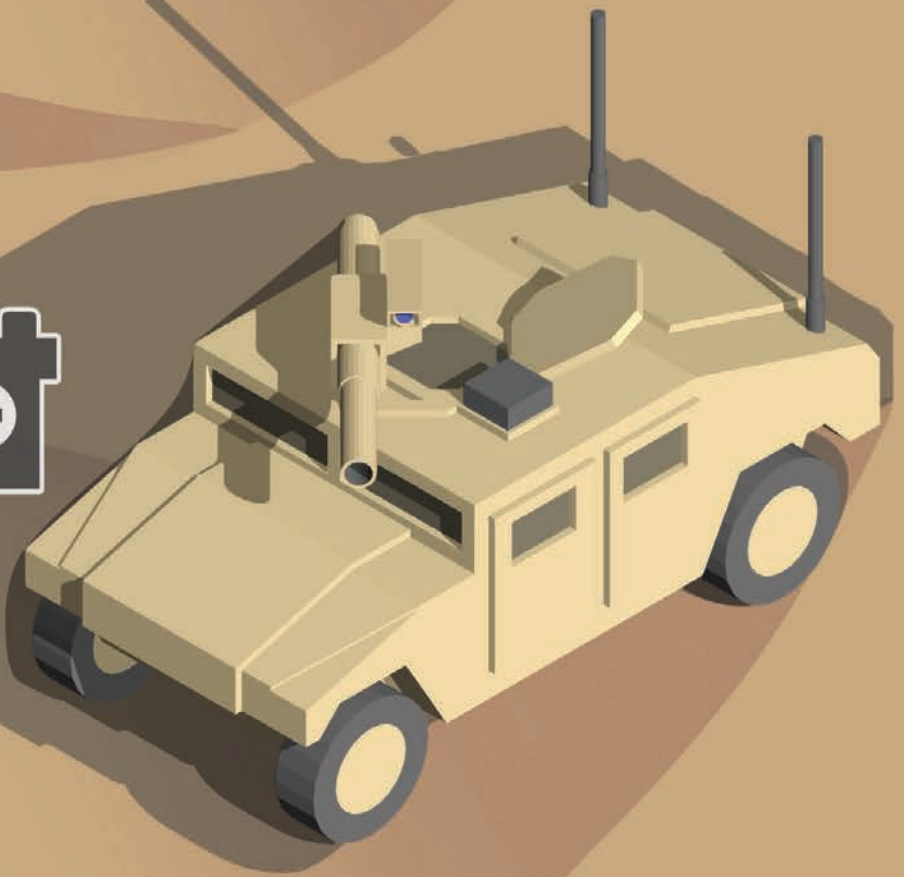
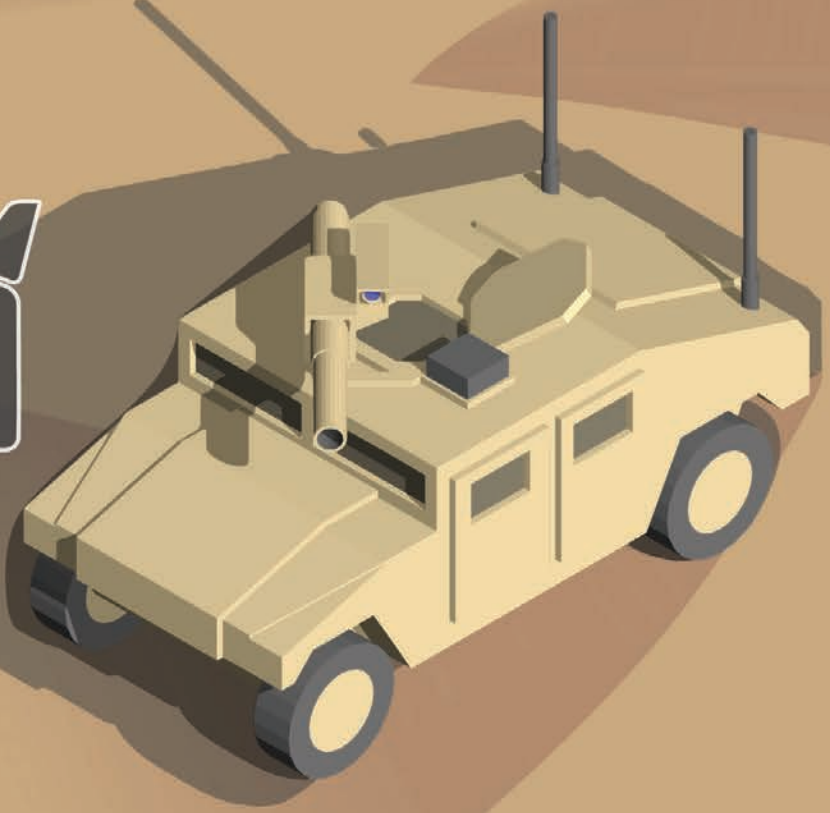

Illustration by USAASC

DRIVING FUEL CHOICES

The Army's requirement calls for the highest energy-density fuel combined with the lowest mass and volume—and gasoline and diesel win over alternative energy.

by Dr. David J. Gorsich and Dr. André Boehman

On any given day, a large Army division may use up to 6,000 gallons of fuel, and cost estimates to ship it to theaters of war in the Middle East can run as high as \$400 per gallon. The Pentagon refers to this figure as the “fully burdened” cost of fuel because it incorporates a lot of factors that come into play when determining the cost.

In Afghanistan, for instance, the challenging geography and scant infrastructure, not to mention the ever-present roadside bombs, present logistical challenges that are expensive to overcome. Since there are no seaports, commercial trucks must transport fuel from ports in Pakistan and haul it overland. Once it reaches rearward areas, military transports must distribute the fuel to forward operating bases, many times by helicopter, which is the most expensive way to transport—hence the exorbitant costs.

In 2008 alone, approximately 68 million gallons of fuel were supplied per month to support U.S. military operations in Iraq and Afghanistan, and in the 2014 fiscal year, DOD consumed 87.4 million barrels of fuel, which supported its global presence, training at home and overseas, and logistical resupply. Obviously, reducing fuel consumption by military vehicles and generators, as well as developing other technologies to provide electricity at forward-deployed locations, would provide significant financial benefits and reduce casualties.

So why isn't the U.S. Army using alternative forms of energy and powertrains more extensively to reduce fuel usage for its vehicles?

Tesla is building large semitrucks, and UPS and FedEx are starting to order these vehicles for delivery operations. It seems the entire automotive industry is migrating toward electrification as battery costs have dropped dramatically and recharge times and range have improved accordingly. With all of the major automobile manufacturers moving toward hybrids and electric vehicles, it's easy to get confused and wonder why the Army is so far behind.

The reality is that the Army is not behind. It has experts in all of these fields who have been conducting research on alternative energy sources and hybrids for military vehicles for more than 20 years. In fact, the Army Rapid Capabilities and Critical Technologies Office recently awarded BAE Systems a \$32 million prototype agreement to integrate a hybrid electric drive system onto a Bradley Fighting Vehicle. The development program is part of the Army's effort to increase vehicle efficiency and boost power generation to support integration of future technologies and improve mobility for combat vehicles on the battlefield.

However, the bottom line is that there is a good reason the Army hasn't unilaterally decided to switch to alternative fuels. The Army has a unique set of operational requirements, and no current fuel source meeting those requirements contains as much energy, by weight, as diesel or gasoline. Nor is there an alternative form of energy that can be carried or generated on board that, in terms of size or volume, is not at least four to 10 times that of gas and diesel. Electrification of the Army's ground fleet (for example, by fielding integrated starter generators on tactical vehicles), is very important, but it still relies on diesel as the primary energy source.

This analysis focuses on energy density (the amount of energy stored in a system per unit of volume), conversion of that energy, as well as mass and volume requirements, to determine how they compare with current sources. The full technical paper was published in the *Journal of Energy Resources Technology* by Andrew Mansfield et al. Titled "Assessment of Conventional and Alternative Energy Carriers for Use in Military Vehicle Platforms," the paper was published online Aug. 31.

BACKGROUND

This study builds on past studies conducted primarily through the U.S. Army Hybrid-Electric Vehicle Experimentation and Assessment program. To understand why the Army still relies on diesel and gas, we need to understand the Army's requirements, operating environment and how energy is stored and transformed into vehicle motion.

That's done through a process that starts with an energy carrier, which is a substance (fuel) or "material state" that stores energy that can be later converted to other forms such as mechanical work or power. We use the term "energy carrier" because it refers to energy that can exist in a variety of forms and can be converted from one form to another. Such carriers may include springs, flywheels, electrical batteries, pressurized air, hydrogen, petroleum, coal, wood and natural gas. A flywheel is a spinning mechanical device that is used to store rotational energy that provides continuous energy when the energy source, say torque from the engine, is intermittent.

Thus, energy carriers are the vehicle's onboard store of energy, which is transformed into useful mechanical energy through a conversion device, such as combustion engines, electric motors or fuel cells. This process provides mechanical energy that can drive a vehicle transmission, which then can produce power such that:

Energy Carrier → Conversion Device → Mechanical Energy

There are several categories of transportation-applicable energy carriers, i.e., those that can reasonably be stored on board a vehicle, such as chemical and mechanical energy carriers. The various energy carriers and conversion devices considered in

this analysis are illustrated in Figure 1. They are: hydrocarbon fuels (gas or diesel), batteries, supercapacitors, hydrogen (fuel cell) and flywheels.

Batteries and supercapacitors (electrochemical devices similar to batteries but designed to produce very high specific power, i.e., for use in regenerative brakes on hybrid vehicles) are often compared in terms of their energy and power. Batteries have a higher energy density (the amount of energy that the system can store), compared with supercapacitors, which have a higher power density (the rate of energy that the system can release).

That makes supercapacitors particularly suitable for storing and releasing large amounts of power relatively quickly, whereas batteries are capable of storing large amounts of energy over long periods of time.

ANALYSIS

Key military requirements assume that fuels will need to be transported to the battlefield, so there is a need for high-energy dense fuels with low weight, as well as a way to generate electricity. That's because a typical Soldier carries four or five electronic devices—and in the future that burden will likely double—and such devices are useless without electrical power generation. Modern lithium ion (Li-ion) batteries cannot keep up with demand even if a Soldier could carry a large supply.

Figure 2, Page 103, summarizes the performance characteristics of commercial energy carriers and promising future technologies, and illustrates the distinct superiority of diesel and gasoline fuels. They are by far the most widely used energy carriers and are used in conjunction with internal combustion engines or gas turbines with varying levels of commercialization.

FIGURE 1

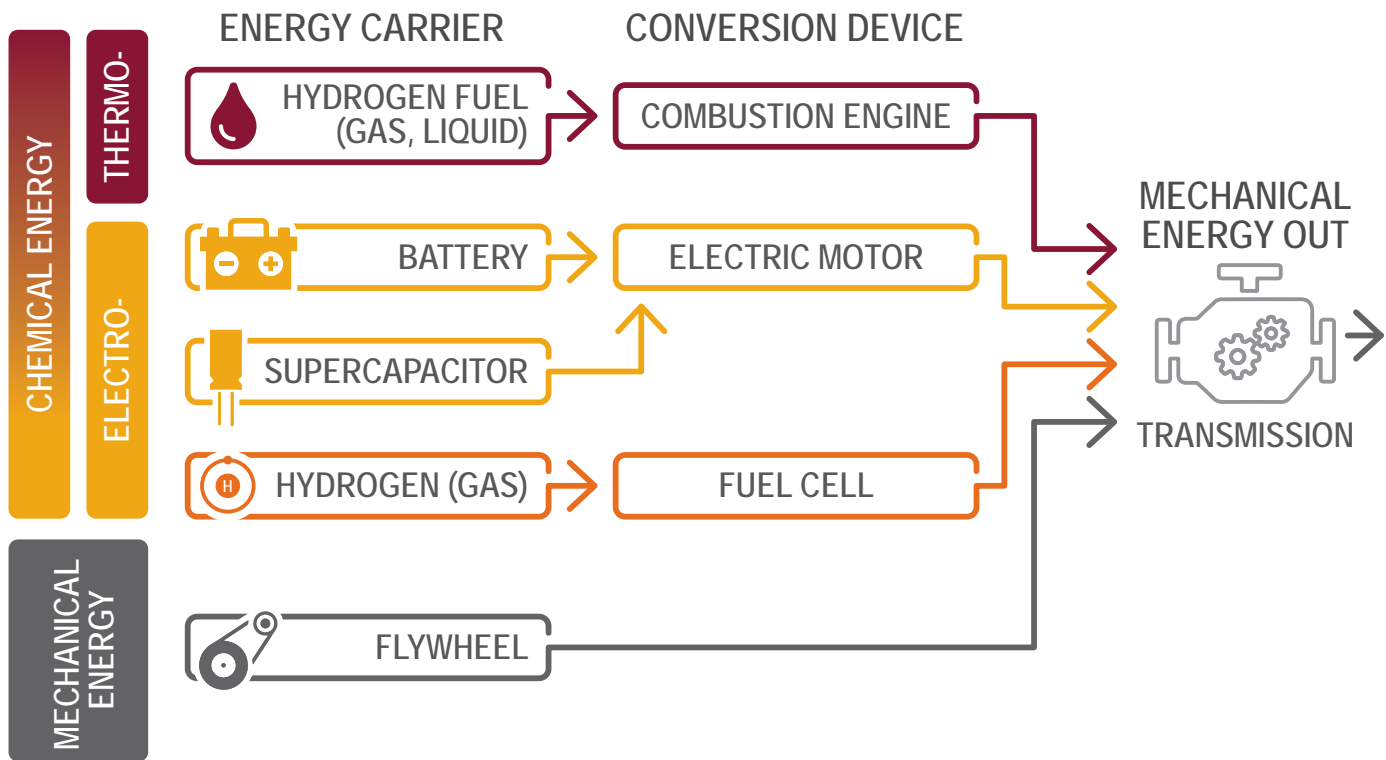

THE OPTIONS FOR ENERGY

Vehicles can draw energy from a variety of sources, with conversion through a variety of devices. The graphic shows the energy carriers and conversion devices that the Army considers most relevant to fuel transportation, i.e., those that can reasonably be stored on board a vehicle. (Graphic by the authors)

Commercialization (COM) refers to the mass-market availability of a particular technology. Generally, the cheaper a technology is, the more widely available it will be for Army use. Therefore, the higher the commercialization ([↑] signifies increasing and [↓] decreasing), the more practical the fuel is for implementation in Army vehicles. Subsequently, it becomes a factor in our best energy carrier options and the new equation is as follows:

$$\text{(Energy Carrier + Conversion Device) + (↑) COM = Mechanical Energy (Best Performance Characteristics)}$$

Factors such as cost, reliability and commercialization strongly impact the usefulness of some of the options in Figure 2. Typical fuels (with their ease of commercialization given in parentheses), can be liquid, such as kerosene (high), diesel (high), gasoline (high) and ethanol (medium); or gaseous, such as methane and

natural gas (medium to high). Lithium air (Li-air) batteries and hydrogen are middle to low performers, with similar energy density to fuels but an order-of-magnitude lower specific energy. Li-ion (medium to high) and nickel-metal hydride (NiMH; high) batteries, as well as flywheels (high) are at the lower end of performance with an order-of-magnitude lower energy density and specific energy values compared with high-performance electrochemical energy carriers.

NiMH batteries have become very well established in the marketplace, while Li-ion batteries are more recently commercialized. Li-air batteries (low) are a very promising future technology that is not yet commercial.

Many full or partially electric vehicles from the past decade use NiMH batteries. Newer electric automotive vehicle

manufacturers, such as Tesla, have chosen to use Li-ion batteries.

The conversion devices considered were combustion engines, electric motors and fuel cells. Their performance characteristics can be seen in Figure 3, Page 104, which shows a measurement of the actual performance of each power source versus its power output. Electric motors have the highest level of performance, but, as we saw earlier, they are connected to batteries that don't have enough stored energy to last for military applications. Gasoline and diesel combustion engines are next, with methane engines at the lowest level.

ENERGY CARRIERS TAKE UP SPACE

Another important factor when considering alternative energy carriers is how much vehicle space will be required to transport the requisite fuel as well as all of the ancillary equipment necessary to operate and adequately power the vehicle system.

In order to assess and compare approximately how much onboard space each alternative would require, researchers evaluated the approximate space claims by comparing the energy carrier volume and powertrain mass associated with each carrier with regard to the Humvee and Family of Medium Tactical Vehicles (FMTV) platforms. Figure 4, Page 105,

There is a good reason the Army hasn't unilaterally decided to switch to alternative fuels.

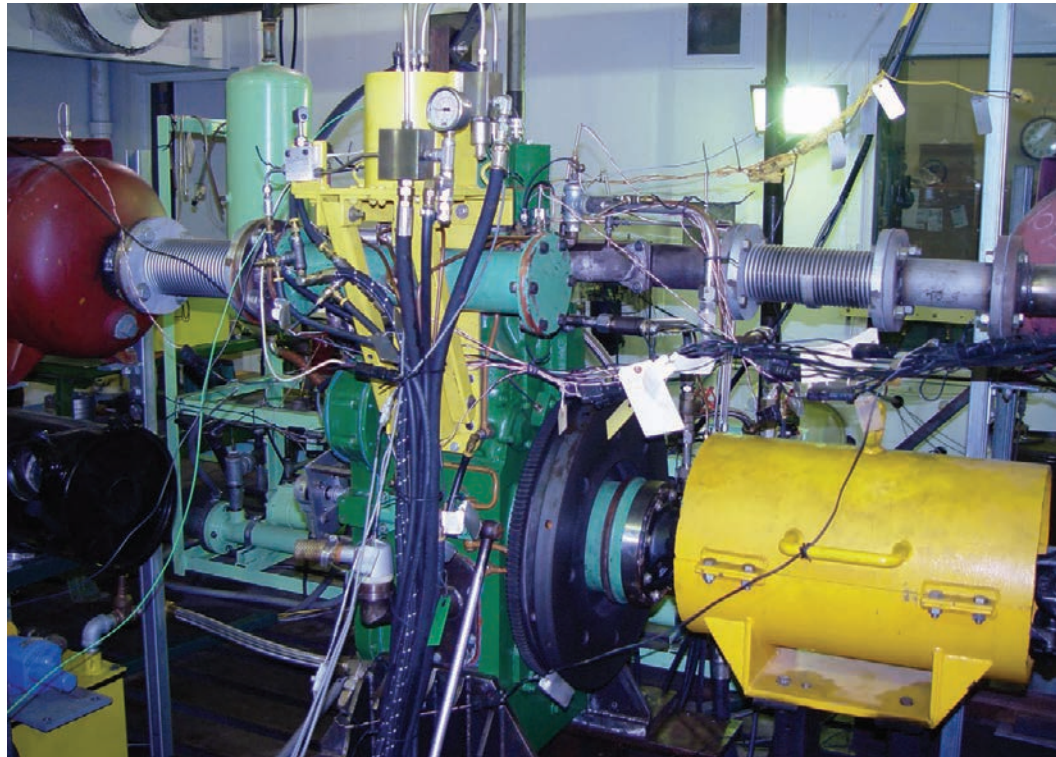

FLYWHEEL POWER

The flywheel of a Cummins engine, at lower right, is hooked up to a dynamometer, above, that measures its mechanical force, torque or power—torque being a force that produces or tends to produce rotation or torsion. A flywheel is an energy carrier; it's a heavy wheel attached to a rotating shaft so as to smooth out delivery of power. As it spins, the inertia of the flywheel opposes and moderates fluctuations in the speed of the engine and stores the excess energy for intermittent use. (Photo by Dr. Pete Schihl, U.S. Army Combat Capabilities Development Command Ground Vehicle Systems Center)

illustrates the predicted total powertrain mass and energy carrier volume for various single and dual hybrid energy carriers for the two vehicle systems. The results indicate that diesel and gasoline fuels are clearly the optimal energy carriers for both vehicle systems, with the lowest total powertrain masses and low energy carrier volumes.

This is true of the results for both single energy carriers in the left-side graphs of Figure 4 and for dual hybrid carriers (diesel + battery or supercapacitor) in the right-side graphs. Of the dual hybrid

energy carriers, diesel fuel + Li-air hybrid is clearly optimal, yielding the greatest rate of hybridization (50 percent diesel and 50 percent Li-air) considering the relatively small mass and volume increases. These results also clearly indicate the dramatic benefits of Li-ion and Li-air battery technology over more traditionally used NiMH.

A prime candidate for an alternative-energy carrier for military vehicles would include an optimized fuel source and conversion device, a high level of commercialization, as well as a system mass and

volume as small as possible. In general, smaller (↓) mass and volume (M&V) alternatives increase the operational effectiveness of vehicles and, therefore, become part of our equation as follows:

$$(\text{Energy Carrier} \rightarrow \text{Conversion Device}) + (\uparrow) \text{COM} + (\downarrow) \text{M\&V} = \text{Mechanical Energy (Best Performance Characteristics)}$$

With respect to batteries in both single and dual energy systems, the three alternative energy technologies considered here resulted in dramatically different total powertrain mass and energy carrier volumes—much larger than for diesel fuel systems. Use of NiMH batteries results in a total mass *15 to 22 times larger and energy carrier volume 25 times larger than the diesel fuel system*. Li-ion batteries are a dramatic improvement over NiMH, resulting in a total mass *only 4.5 to 7 times larger and energy carrier volume 4 times larger than the diesel fuel system*.

Even with this improvement, the large mass and volume increase over a diesel fuel system presents a significant challenge to its implementation, as driving performance and usable volume would likely fall dramatically. The effect of large mass and volume increases for Li-ion battery systems in similar large vehicles is evident in the short 300–500 mile range of the Tesla semitruck, which uses Li-ion batteries, compared with a more typical 1,000-mile range for a diesel semitruck.

Relative to diesel fuel, *both hydrogen and methane yield similar total powertrain masses but significantly larger (3-5 times) energy carrier volumes*. This highlights the primary issue with the low energy density of gaseous fuels and indicates that at existing and near-term technology levels, if these fuels are used as the single energy carrier for military ground vehicles, a large portion of their usable payload carrying capacity (volume) would be lost.

FIGURE 2

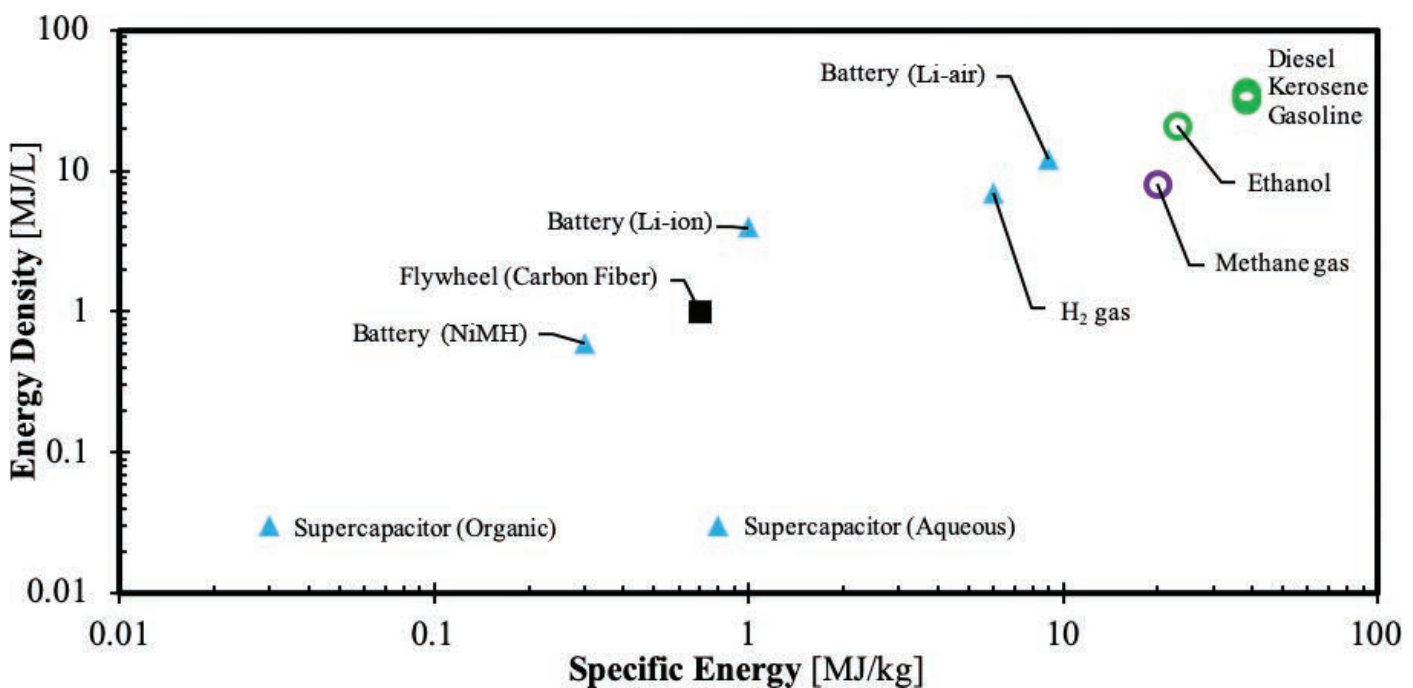

HOW THEY PERFORM

An analysis comparing the performance of various possible energy carriers for Army vehicles, including commercial energy carriers and promising future technologies, shows a marked superiority for diesel and gasoline fuels. Specific energy is energy per unit of mass; energy density is the amount of energy stored in a battery or tank per unit of volume. (Graphic by the authors)

FIGURE 3

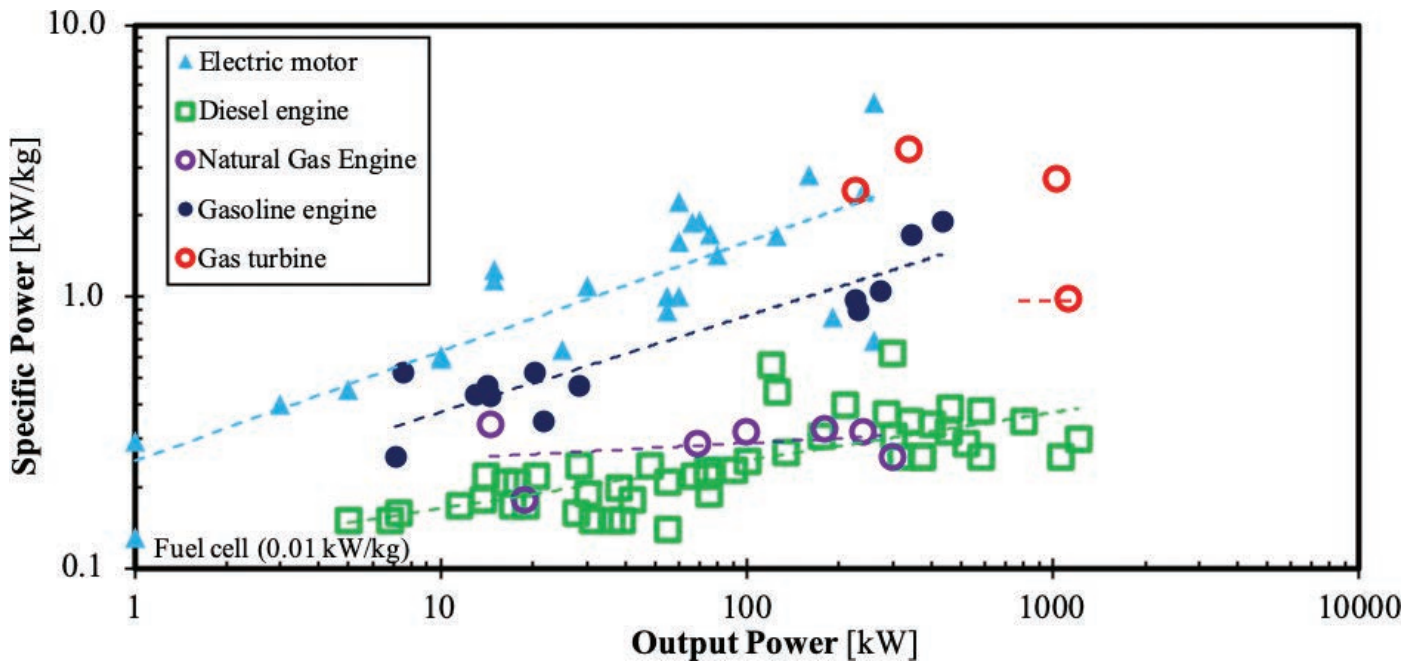

THE QUESTION OF CONVERSION

A comparison of various conversion devices—combustion engines, electric motors and fuel cells—looked at the actual performance of each power source versus its power output. Although electric motors have the highest level of performance, the authors found, they are connected to batteries that don't have enough stored energy to last for military use. Specific power, or power-to-weight ratio, is a measure of engine performance in units of kilowatts (kW) per kilogram (kg). (Graphic by the authors)

CONCLUSION

The Army has a unique set of requirements that cannot currently be better satisfied with anything other than gas or diesel as the primary energy carrier. Considering the high torque performance of diesel combustion engines, diesel fuel is clearly the optimal energy carrier for the Army's ground vehicle platforms, from the perspective of both the total powertrain mass (energy carrier + conversion device), and stored energy volume.

Military applications provide common and unique challenges for energy storage systems and energy density, with regard to mass and volume, and are critical

challenges for commercial and military energy storage systems. Energy storage systems for military applications must be able to be stored and operate reliably at low and high temperatures (minus 46 to 88 Celsius) and under greater shock and vibration conditions than commercial systems. Cooling systems for military energy storage and export power solutions are complicated by the harsh environmental conditions they must withstand. Consequently, this combined scenario continues to drive the Army toward liquid fuels and their physical properties.

In the future, for the Army to consider a fleetwide, wholesale change that moves

away from hydro carbon fuels, it needs to develop a very detailed strategy and step-by-step paths to acquire any new technologies. This hasn't happened yet because there are still too many obstacles that need to be resolved before alternative energy carriers can become a viable option for full-scale use. So for now, the Army still relies on carbon-based fuels, which will likely remain the primary fuel. It is unlikely, in terms of scale and scope, that the Army will transform to something else in the next 10 years. While alternative power-generation exists now in many different forms, alternative fuels aren't ready for prime time when it comes to large-scale Army use.

FIGURE 4

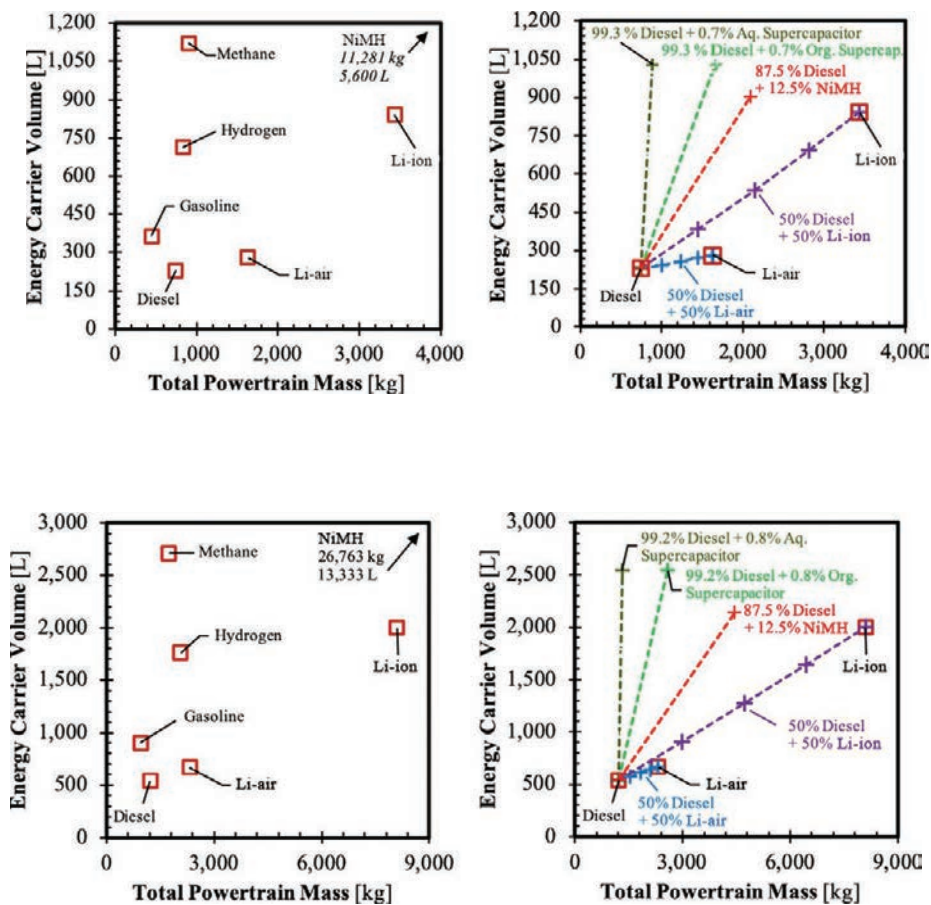

TAKING UP SPACE

The amount of vehicle space required to transport a fuel, in addition to the equipment necessary to operate and power the vehicle system, is a key consideration when considering energy carriers. The authors' analysis looked at the approximate space claims of each energy source by comparing the energy carrier volume (in liters) and powertrain mass (in kilograms), specifically for the Humvee and FMTV platforms. The results indicate that diesel and gasoline fuels are optimal for both vehicle systems. (Graphic by the authors)

For more information, visit <https://arc.engin.umich.edu>, the website of the Automotive Research Center, a university-based U.S. Army Center of Excellence for modeling and simulation of military and civilian ground vehicle system. Co-authors Gorsich and Boehman are the center's government

executive director and leader of its engines work group, respectively. Or contact Gorsich, Chief Scientist, U.S. Army AFC-CCDC GVSC, 6501 E. 11 Mile Road, Building 200A, Warren, MI 48397-5000; or david.j.gorsich.civ@mail.mil.

DR. DAVID J. GORSICH serves as the Army's chief scientist for ground vehicle systems. His current research interests are vehicle dynamics and structural analysis, reliability-based design optimization, underbody blast modeling, terrain modeling and spatial statistics. He holds a Ph.D. in applied mathematics from the Massachusetts Institute of Technology, an M.S. in applied mathematics from George Washington University and a B.S. in electrical engineering from Lawrence Technological University. Previously he served as the U.S. Army Tank Automotive Research, Development and Engineering Center's (TARDEC) associate director for modeling and simulation, culminating his service at TARDEC, where he was also the acting director for strategic plans and programs (G5) and the team leader for robotics and vehicle intelligence. He also served the U.S. Army Materiel Command, the Army Research Laboratory and the Assistant Secretary of the Army for Acquisitions, Logistics and Technology.

DR. ANDRÉ BOEHMAN is a professor of mechanical engineering at the University of Michigan, director of the university's Walter E. Lay Automotive Laboratory and the associate director of the Automotive Research Center. He holds a Ph.D. and an M.S. in mechanical engineering from Stanford University and a B.S. from the University of Dayton, all in mechanical engineering. His research interests are in alternative and reformulated fuels, combustion and pollution control. He served as editor-in-chief of the *Journal of Fuel Processing Technology* and presently is an associate editor for *Energy & Fuels*. He was elected a 2011 Fellow of the Society of Automotive Engineers. He received the 2009 John Johnson Award for Outstanding Research in Diesel Engines and the 2009 Arch T. Colwell Merit Award from the Society of Automotive Engineers.

LEADING AN AGILE WORKFORCE IN TIMES OF CRISIS



USACE made employee welfare its top priority during the pandemic.

by Gwendolyn L. Miller and Dr. Tiffanie A. Nichols

A year ago, no one could have predicted an almost 100 percent virtual work environment throughout the world because of a pandemic. Every aspect of daily life has been impacted—schooling of children, caring for elderly relatives and shopping for household essentials—with little exception. Michael Dolly, from the U.S. Army Corps of Engineers (USACE) Kansas City District Contracting Office, expressed his disbelief, “Having two young kids, I was certainly shocked when our school district decided to close schools this past spring due to the COVID-19 pandemic,” he said. “At first, I was worried because I wasn’t sure how my family would be able to continue our children’s education for the rest of the school year while I continued to work full time.”

Two overarching questions guided our response to these events: What do leaders do when their traditional organization is faced with a completely virtual working environment? More importantly, how do you holistically support your staff in a time of such uncertainty and fear? Tackling these questions allowed us to view the problem from multiple angles, with the ultimate goal of meeting the mission while ensuring the safety of our workforce. We undertook several initiatives in response to these questions, including establishing a Morale Committee to engage with our workforce in an authentic and connected manner, forming a Welcome Wagon for additional support with onboarding new employees, holding weekly Chief of Contracting Office town hall events, and providing logistics support for work schedule flexibility, equipment for home use and connectivity.

WE’RE IN THIS TOGETHER

One of the greatest concerns of USACE leaders, while moving to a completely virtual environment, was the possibility of a disjointed and disconnected team. In a recent article in *Chief Executive*, “Maintaining Your Team’s Morale and Productivity During Covid-19”, Denise Graziano asserts that one way to increase



THE DIVISION

The Kansas City District Contracting Division is pictured with then-Deputy Assistant Secretary of the Army for Procurement Stuart Hazlett, outside of the Bolling Federal Building in downtown Kansas City, Missouri, on October 22, 2019. (Photo by John "Rusty" Thomas)

morale during uncertain times is to let the team control organization initiatives. To this end, the Contracting Division established two working groups, made up of non-supervisors, to tackle the issue of maintaining and increasing morale: the Morale Committee and the Welcome Wagon. Contracting Division leaders also enlisted the help of a leadership coach to ensure our actions were deliberate, well thought out and considered the safety and well-being of our team members—our No. 1 priority.

Morale Committee member Stephanie Kretzer said the committee "is a great way to keep people engaged while they're at home and sometimes isolated by themselves." Employees, who for years had enjoyed breakfast together or met for

informal breaks over coffee, were no longer able to do so. So the committee set out to develop virtual events to engage the team in fun activities, meant to offset the lack of in-person interactions that normally occur in the office. The first activity was a challenge for staff to submit pictures of their most entertaining telework attire. Interactive bingo was next, and then several employees participated in a home scavenger hunt. The committee received feedback that these activities were a little time consuming, so they began a weekly trivia contest. Winners received gift cards from local small businesses, to help support the economy while incentivizing employee participation.

Each week, we saw more and more employees participating and communicating with

each other. A key member of the morale committee, Gary Rizzolo, said, "I think the most successful part of the Morale Committee is it gives people opportunity to interact with other personnel." These interactions would not occur without the proactive engagement and dedication of the committee members. In the end, it was refreshing to see the smiles and positive interactions that came from these activities. The committee continues to seek feedback and make adjustments to the activities, to ensure employees have an outlet to reduce stress and interact with their coworkers on an informal basis.

ROLL OUT THE RED CARPET

Recruitment and onboarding did not stop as a result of the pandemic, which has created the challenge of integrating new

employees into the team in a virtual environment. None of our new employees had ever worked for USACE, and most were summer hires or recent graduates being introduced to the federal government and the Army. While supervisors were actively reaching out to complete the normal onboarding requirements, we quickly discovered that integration with the rest of the team was sorely lacking. The Welcome Wagon was established with the express purpose of bridging the normal integration process that new employees experience in the traditional work environment.

Leaders intentionally selected a diverse team so that different levels and types of experiences were represented. In particular, people who had been with the organization less than a year were included, since they had the most recent onboarding experience and would better relate to the new employees. Roy Maurer, with the Society for Human Resource Management, reminds managers that onboarding is much more than completing paperwork or a one-time introduction to the organization in his article “Virtual Onboarding of Remote Workers More Important Than Ever.” Maurer said true onboarding sets the stage for the new employee’s success and happiness, and that includes establishing relationships and a sense of belonging. One of the contracting office’s newest employees, Geoffrey Gould, provided feedback on his experience with the Welcome Wagon. “I especially like the interaction with other teams [and] branches, so that we got a better insight in what they do, which allowed me to better understand my role in carrying out the agency’s mission.”

Meeting weekly in group settings, the Welcome Wagon ensured employees had an additional resource other than their supervisor to reach out to, something that under normal circumstances would naturally occur. Each Welcome Wagon

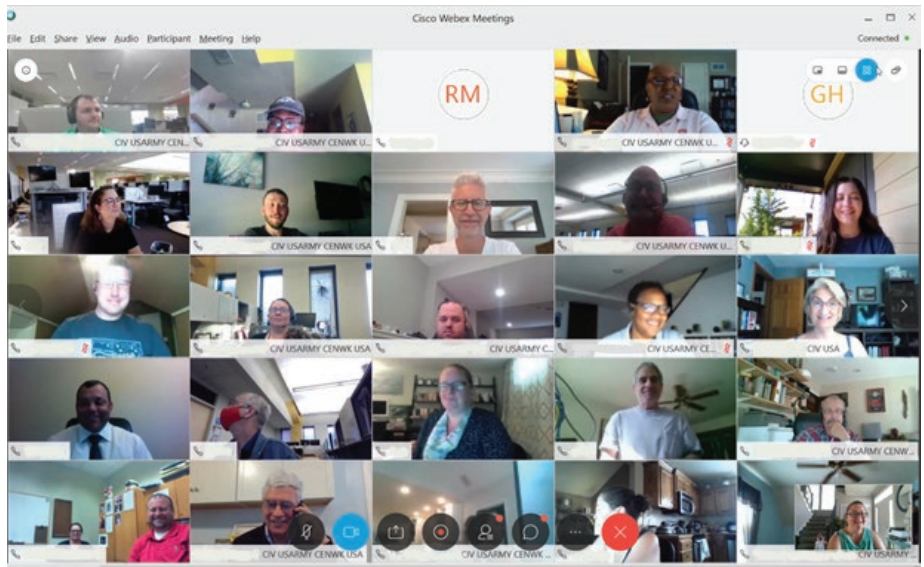

ALL TOGETHER NOW

Employees from the Kansas City District USACE participate in virtual town hall this past July. Events like this helped facilitate better communication and upheld morale for the district. (Image courtesy of Gwendolyn Miller)

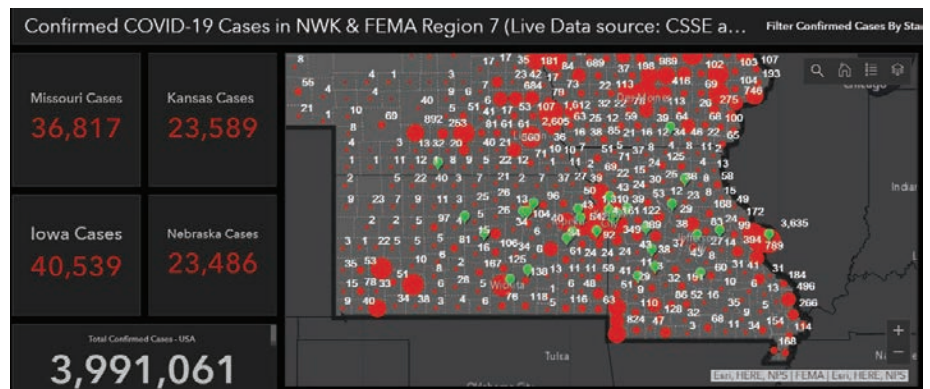

INFORMATION UPDATE

As part of the weekly town hall meetings, co-author Gwendolyn Miller, the district chief of contracting, shares up-to-date information on the number of COVID-19 cases in the district’s area of responsibility.

We will take these lessons and prepare for tomorrow, ensuring that we are a stronger, more cohesive team that can be depended on to respond to any threat.

member also participated in multiple one-on-one sessions with the new employees, providing contracting and district resources, such as training, handouts, contacts and advice on how to be successful within their contracting role. This allowed new members to further integrate within contracting, and provided another resource for them to ask questions and seek further knowledge from more seasoned employees.

In particular, the Welcome Wagon has received positive feedback on these introductory meetings. During these WebEx calls, the employees within the contracting division would each briefly activate their camera to introduce themselves, give a little background and advise how they may be helpful to the new employees in the future. Welcome Wagon member Thomas Beyer said, “We made sure that new employees were engaged with us outside of the normal channels of their workload.” Thomas also spoke to the new employees about expectations and empathized with their feelings as new employees working virtually. Additionally, Thomas worked with the district training coordinator to develop and provide a full training packet along with helpful documents and how-to files that he distributed to the new employees. Since the Welcome Wagon’s inception in April, the committee has sought and incorporated several rounds of feedback from various new hires into the processes.

A NEW NORMAL

In “Linking Crisis Management and Leadership Competencies: The Role of Human Resource Development,” authors Lynn Perry Wooten and Erika Hayes James outline the five stages of a crisis. They are signal detection, preparation and prevention, damage control and containment, business recovery and reflection and learning. The steps undertaken by district leaders intuitively followed the

theory established within this framework and offered insight into future contingency planning. Within this framework, business recovery was imperative because the Kansas City District’s purpose is to solve some of the nation’s toughest challenges. We support critical infrastructure, military installations and recreational areas throughout our area of operations, including Kansas and Missouri, as well as portions of Colorado, Iowa and Nebraska. While the organization quickly adjusted to the new normal of virtual life, addressing the various challenges (distribution of bandwidth, connectivity issues, hardware failures, etc.), leadership was looking ahead. The main concern for the entire organization: How do we maintain employee engagement, avoid burnout and prepare for the eventual return to our offices?

The first focus for leadership was to establish town halls with the Chief of Contracting Office and its 66 employees. Within the contracting organization, there are five different branches, encompassing a multitude of acquisition job series, such as purchasing agents, procurement technicians, contracting specialists and procurement analysts. The division also includes a military contingency contracting team of several active-duty 51C professionals. The town hall meetings served multiple purposes: disseminate critical information, share good news and establish the baseline that everyone is in this situation together. Perhaps more importantly, District Contracting Chief Gwendolyn Miller (and co-author) attempted to normalize the situation that many families were now experiencing.

Embracing this format, leaders successfully modeled communication tools that were not a normal part of daily work life. An article in the *Nature Human Behavior* journal from May 2020, “Using Social and

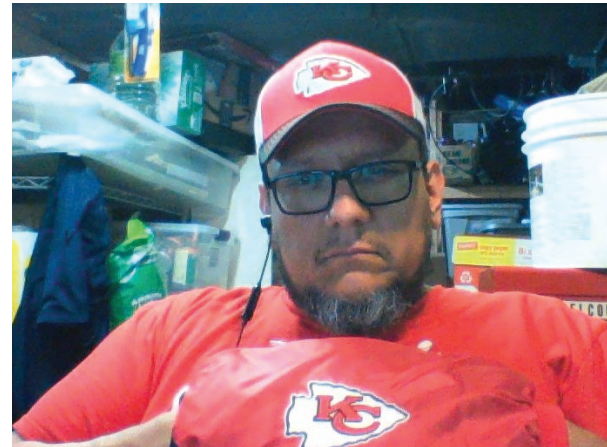

HOME-TEAM SPIRIT

David Best put on his winning “Mahomes Tough” look for the Morale Committee’s first activity in April 2020. Go Chiefs! (Photo by David Best)



VICTORY IS CAFFEINATED

Micah Duckworth was the winner of the first Morale Committee activity in April 2020, and he received a virtual gift card to a locally owned small business coffee shop. (Photo by Micah Duckworth)

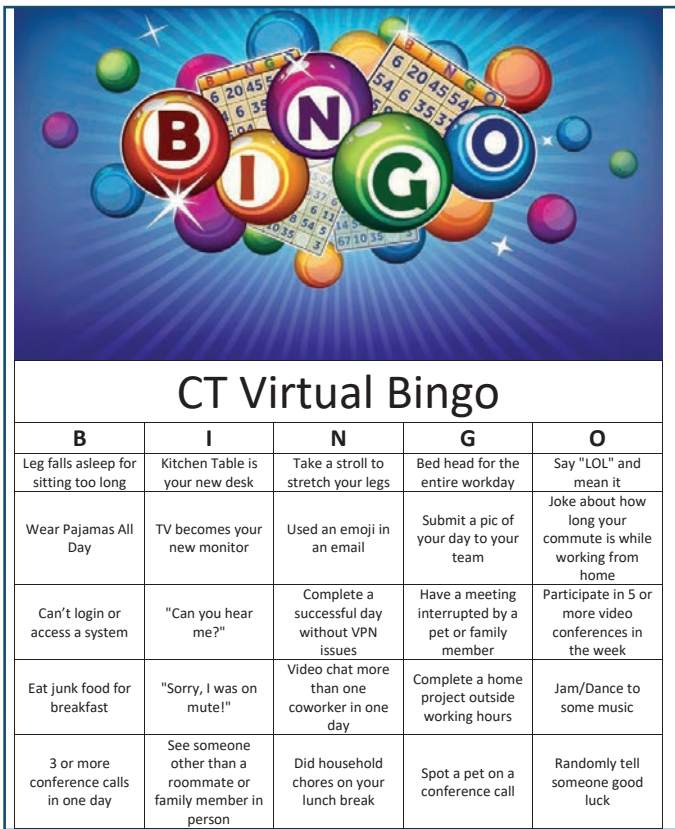

WE HAVE A WINNER

The Morale Committee organized several events to help employees stay connected during the pandemic, like virtual bingo. (Image courtesy of the Morale Committee, KCDC)

Behavioral Science to Support COVID-19 Pandemic Response,” by Jay J. Van Bavel et al., notes that people prefer leaders who promote a sense of togetherness rather than individualism. Additionally, they prefer leaders to communicate their expectations and their trust in their subordinates, which enables greater success during times of pandemics. This article reinforced that the actions undertaken for communication within the organization were appropriate and relevant.

The town hall meetings were held twice a week for about 30 minutes each during the initial transition to a virtual work environment. They were always conducted in a WebEx interactive video format, and even though participation via video was not mandatory for the team members, about half of the office chose to share their video streams during each meeting. The face-to-face visual allowed for a better sense of connection while physically separated. During these calls, Miller would also share her personal

experiences, such as supporting local small businesses through curbside meal programs, gardening tips and family activity recommendations.

When the initial chaos of transitioning to a new normal had calmed, leadership let the team recommend how often to hold the meetings, resulting in a reduction to once a week. This decision was based on a decrease in angst among the employees, the completed transition to the virtual work environment and feedback received from the team members. The face-to-face format allowed the entire organization to see each other facing the same work-life balance challenges while working from home during a quarantine.

ROLL WITH THE PUNCHES

Given the almost complete shutdown of businesses and schools, it was imperative that we understand how to support individuals who could not work their traditional schedules because of new life challenges. For the first time, many schools conducted classes virtually, day care centers were closed and some individuals became full-time caretakers.

The solution to this problem was instituting a new working schedule that allowed maximum flexibility in performing daily work requirements. This maxi-flex schedule permitted employees to work anytime between 4 a.m. and midnight, Monday through Saturday, with additional flexibilities to work up to 10 and a half hours in a day, and a maximum of 60 hours in a week. This not only accommodated the changing personal needs of our workforce during the crisis, but also allowed for mission execution to continue through difficulties with distribution of virtual private network (VPN) bandwidth.

Employee Joan Clarkston said, “I have loved maxi-flex. Being everyone is home right now, there are some moments that are quieter than others and it has allowed me maximize those opportunities to give the job my best. Also, with social distancing, it has provided me the necessary flexibility to run to the store when it isn’t as busy. Normally, I would have to take leave to do it during a regular work day.” Other employees have reported that taking advantage of the maxi-flex schedule has allowed them to care for sick family members and adjust their work hours to meet competing personal priorities.

This has ensured timely mission success without sacrificing quality, while also supporting employees’ complex personal responsibilities. “I have been able to achieve a better work-life balance than ever before, resulting in less stress and more

The face-to-face format allowed the entire organization to see each other facing the same work-life balance challenges while working from home during a quarantine.

productivity,” Michael Dolly said. “Also, knowing that my organization’s leadership has confidence in me to manage my time appropriately and responsibly adds to my overall job satisfaction.”

Secondary logistical concerns were centered on equipment and accessibility. With entire family units now working and attending school from home, personally owned equipment previously used for situational telework, such as a monitor or keyboard, was now being shared among multiple family members. Without the additional equipment, employees expressed concern for prioritizing mission essential deadlines while also ensuring their family members were able to meet their work and school commitments. The contracting organization used the principles and tenets of the Army Command Supply Discipline Program to maintain control of government property while providing the necessary resources to the employees.

We took stock of our inventory and allocated monitors and docking stations to our people, allowing our staff to quickly set up home offices for a more seamless transition to a virtual work environment and freeing up personal equipment to be used by other family members. Contracting leadership successfully mitigated the logistical stress that accompanied the unprecedented demands of employees now forced

to conduct both their professional and family daily activities from home. Positive feedback in response to this simple action was shared with senior leaders, who quickly implemented the practice within the other divisions of the district as well.

CONCLUSION

Leadership researchers Arjen Boin, Paul ‘t Hart, Allan McConnell and Thomas Preston discuss the importance of leadership both during and after crisis events in their paper “Leadership Style, Crisis Response and Blame Management: the Case of Hurricane Katrina.” They write that one of the key tasks for leadership in the recovery process is to re-establish a sense of normalcy. With an event as life-altering as the COVID-19 pandemic, we should all expect a new normal to emerge. Perhaps this means increased telework or virtual employment, having systems at the ready to accommodate a sudden surge in capacity requirements or other technical needs.

For the Kansas City District Contracting Division, the new normal will be impacted by the lessons we have learned about people. Engaging in transparent and frequent communication, ensuring a proactive approach to morale and empowering employees to positively contribute to their work environment, will all be enduring changes that we take from this otherwise taxing experience. One of the newest USACE contracting employees,

Nichole Anderson, said, “Joining any team during this pandemic can cause any new employee to have additional stresses. You worry if you will be able to fully integrate or get the support and questions answered that you might need while working primarily away from the office as you begin. The contracting organization, through initiatives like the Welcome Wagon, has relieved any such worries for me because it has given me an opportunity to talk over any issues and to fully form relationships that have greatly helped to introduce me to my new role.” In the end, we will be a better organization, one that has proven to be agile and effective even in the most challenging of environments. We will take these lessons and prepare for tomorrow, ensuring that we are a stronger, more cohesive team that can be depended on to respond to any threat.

For more information, go to <https://www.nwk.usace.army.mil/>. For information on careers at Kansas City District Contracting Office, email kc.contracting.career@usace.army.mil.

GWENDOLYN L. MILLER is the Kansas City District chief of the Contracting Office, USACE. She has been with the district for four years and with DOD contracting for over 18 years. She has a B.A. in political science from the University of Central Arkansas, is Level III certified in contracting and is a member of the Army Acquisition Corps (AAC).

DR. TIFFANIE A. NICHOLS is a procurement analyst with the Kansas City District, USACE. She has a Ph.D. in organization and management from Capella University and is Level III certified in contracting. She has been with Army contracting for over 11 years and is a member of the AAC.



REAL-WORLD TEST

During PNTAX, developers and Soldiers assessed how more than 80 mounted, dismounted and NAVWAR capabilities and systems operated within a replicated real-world, anti-access and area-denied environment. (Photo by U.S. Army)



CCDC's ROAD MAP TO MODERNIZING THE ARMY: ASSURED POSITIONING, NAVIGATION AND TIMING

Eighth in a series of articles on how the Combat Capabilities Development Command is supporting the Army's six modernization priorities.

by Maj. Gen. John A. George

Maj. Gen. John A. George is the commanding general of the U.S. Army Combat Capabilities Development Command.

GPS is among the most important technologies Soldiers rely on during missions. It allows the real-time flow of information that Soldiers need to form a picture of the battlefield and make informed decisions. GPS also plays a critical role in artillery and aviation platforms supporting Soldiers on land and from the air. Potential adversaries are aware of our reliance on GPS, however, so the Army has to be prepared to operate in environments where the technology has been degraded or denied by enemy action.

To that end, the Army has made one of its six modernization priorities to develop assured positioning, navigation and timing—commonly referred to as APNT—to aid Soldiers in maneuvering the battlefield with greater certainty and situational awareness. APNT synchronizes radio communications and the network with intelligence systems. APNT technologies will ensure our military continues to operate in contested environments and dominate our adversaries.

The U.S. Army Combat Capabilities Development Command's (CCDC) C5ISR Center leads our science and technology initiatives to deliver new APNT capabilities to Soldiers. As a major subordinate command of the Army Futures Command, CCDC's mission is to use its global team of researchers, engineers, scientists and



analysts to provide a world-class scientific and technological foundation for the Army modernization enterprise.

CCDC's C5ISR (Command, Control, Communications, Computers, Cyber, Intelligence, Surveillance and Reconnaissance) Center works closely with other CCDC organizations including the Armaments Center, the Army Research Laboratory and the Aviation & Missile Center. The C5ISR Center also has science and technology representatives within the APNT Cross-Functional Team, with which it and other CCDC centers collaborate continuously to discuss current projects, issues and plans for the future and to ensure efforts are aligned with the cross-functional team road map.

In May, the APNT team was also one of eight cross-functional teams to take part in the first CCDC-cross-functional team home-on-home meeting, in which partners share plans and priorities and work to align their efforts.

"The APNT [Cross-Functional Team] is in the process of evaluating various technologies in the areas of APNT, tactical space and

NAVWAR [navigation warfare], which will make Army systems more resilient and secure, ensuring future generations of America's Soldiers get what they need, when they need it and remain the most lethal and effective land force in the world," said APNT Cross-Functional Team Director William Nelson.

EXECUTING MISSIONS ON LAND AND IN THE AIR

Our C5ISR team has several projects underway to help Soldiers execute their missions with greater certainty, including the Modular GPS Independent Sensors project. This project enables new position, navigation and timing technologies to be added to existing Army air, ground and Soldier platforms quickly and easily as they become available. The plug-and-play framework uses published standards open to government and industry, which will enable the Army to keep pace with innovation and provide Soldiers with the latest technology more quickly.

The open architecture will enable rapid development and upgrades to position, navigation and timing systems, sensors and algorithms as technology matures. C5ISR signed a technology transition



IN THE FIELD

Soldiers from I Corps, U.S. Army Europe, the Colorado and New Mexico National Guards, U.S. Army Special Operations Command, Joint Special Operations Command and the Army Cyber Directorate participated in the PNT Assessment Exercise, or PNTAX, at White Sands Missile Range, New Mexico, in July and August 2019. (Photo by Dan LaFontaine, C5ISR Center)

agreement with Project Manager Positioning, Navigation and Timing (PM PNT), within the Program Executive Office for Intelligence, Electronic Warfare and Sensors (PEO IEW&S), in fall 2019 to advance a modular GPS-independent sensor solution to the field.

Recent history has shown the importance of providing Soldiers with GPS that is reliable and resilient. Soldiers in Afghanistan rely heavily on GPS, but the mountainous terrain inhibits signals, limiting Soldiers' ability to communicate.

The C5ISR NAVWAR project will benefit both Soldiers and commanders by providing a common operating picture of the battlefield. The plug-in solution will fuse data from ground, air and space sensors, and provide real-time information for

mission planning, as well as more effective electronic protection measures. Components of the NAVWAR project will transition to both PM PNT and Project Manager Electronic Warfare & Cyber, also within PEO IEW&S.

PNT is a critical enabler for achieving the five requirements for accurate fire, the highly technical and very specific data that artillery units must continually update in order to use their most accurate and advanced weaponry. PNT is also required for the digital kill-chain sequence, where each link is vital to obtain lethal capability for Army fires.

Our Armaments Center collaborates closely with the Joint Program Executive Office for Armaments and Ammunition (JPEO A&A), PEO Missiles and Space, PM PNT, the APNT Cross-Functional Team, the Long Range Precision Fires Cross-Functional Team and others to develop advanced APNT technologies for current and next-generation long-range artillery munitions and armaments.

The Armaments Center also leverages the expertise of industry, academia and other DOD services to integrate best-of-breed PNT technologies, with a specific focus on next-generation cannon artillery. These technologies include alternative navigation, anti-jam and anti-spoof, M-Code receivers, image-based terminal guidance, and gun-hardened inertial measurement units. M-Code is a GPS signal designed by the Air Force to improve security and provide anti-jamming capabilities for

The Army Research Laboratory is leading a holistic approach to enable GPS-free APNT for dismounted Soldiers, including precise time and exquisite positioning without access to globally networked information.



MISSION CRITICAL

C5ISR Center staff conduct research on position, navigation and timing systems at Aberdeen Proving Ground, Maryland, on Oct. 23, 2019. The systems are critical for Soldiers to maneuver the battlefield with certainty and situational awareness. (Photo by Dan Lafontaine, C5ISR Center)

military GPS. Alternative navigation technologies will enable precision-guided munitions and weapons to utilize non-GPS signals to augment PNT data in a GPS-degraded or denied environment. Anti-jam and anti-spoof and M-code receiver technologies will protect weapons and munitions from hostile attempts to counter our APNT solutions. Gun-hardened inertial measurement units and image-based terminal guidance will enable guided munitions to be more precise by using a variety of sensors and visual cues to adjust the munition's trajectory onto the target.

Ultimately, these technologies will feed into programs within JPEO A&A's portfolio, which includes precision-guided munitions and indirect fire weapon systems. CCDC's work modernizing these technologies will enable the Army to conduct

precision strikes and maintain battlefield dominance and lethality while operating in a GPS-denied or -degraded environment.

APNT solutions for aviation and missile systems will support the critical role Army aviation plays in military operations. The Aviation & Missile Center is working on projects to integrate and test M-Code GPS receivers and anti-jam electronics on the Patriot launcher and Gray Eagle unmanned aircraft system. The integration of M-Code GPS receivers into Army platforms will not only increase our APNT capability, it will also improve joint operations that are critical to the success of the Army's multi-domain operations concept.

Meanwhile, CDCC's Army Research Laboratory (ARL) is leading a holistic approach to enable GPS-free APNT for dismounted

CCDC's work modernizing these technologies will enable the Army to conduct precision strikes and maintain battlefield dominance and lethality while operating in a GPS-denied or -degraded environment.

Soldiers, including precise time and exquisite positioning without access to globally networked information. This will enable units that are separated in battle to function as a cohesive whole and complete their missions. The typical ARL timeline for these technologies has been substantially accelerated to deliver prototypes for Soldier testing within a few years. Key to this effort are Soldier touch-point events in which the ultimate users have an opportunity to evaluate the prototypes and make recommendations early in the development process. This helps the Army deliver better capabilities more quickly.

PUTTING TECHNOLOGY IN SOLDIERS' HANDS

Testing technologies at field exercises that simulate battlefield conditions is one key to the success of the APNT capabilities we are currently developing. We achieved this during the PNT Assessment Exercise, or PNTAX, at White Sands Missile Range, New Mexico, in July and August 2019. Thirty-four Soldiers from I Corps, U.S. Army Europe, the Colorado and New Mexico National Guards, U.S. Army Special Operations Command, Joint Special Operations Command and the Army Cyber Directorate participated in the event.

White Sands Missile Range is one of a few real-world settings where Soldiers can test capabilities in a GPS-denied or -degraded environment. During the exercise,

developers and Soldiers assessed how more than 80 mounted, dismounted and NAVWAR capabilities and systems operated within a real-world, anti-access and area-denied environment. The information we collected is helping us understand how developing systems perform and how they can significantly improve Soldier operations in GPS-contested environments.

We also conduct other Soldier touch-point events throughout the year, including technology demonstrations, capability assessments and live-fire and training exercises. Our scientists and engineers gather feedback through these touch points that ultimately influence how CCDC matures technology to get it ready to transition to our partners. We gain vital insight to ensure new systems will be operationally successful by putting prototypes and systems directly into the hands of Soldiers.

CCDC works with hundreds of nontraditional defense companies, industry and academia partners to capture emerging technologies and refine APNT capabilities. One of the challenges, however, is testing commercial products on the military network. Later this year, we plan to launch the Open Innovation Lab, or OIL, at Aberdeen Proving Ground, Maryland. OIL will enable our industry partners to test their technologies in an unclassified lab with an open architecture. An open architecture not only fosters competition among vendors, it also accelerates

innovation by providing a steady flow of information.

CONCLUSION

CCDC is sharing information gathered from our partnerships with industry and academia and from Soldier touch-point events so we can refine requirements, develop technologies to fill capability gaps and accelerate timelines to field technology more quickly. Equipping Soldiers with the most advanced APNT technology will give them a critical advantage on the battlefield and enable them to fight and win against any adversary.

For more information, go to www.army.mil/ccdc.

MAJ. GEN. JOHN A. GEORGE is the commanding general of CCDC. Before assuming command of CCDC, he served as deputy director and chief of staff of the U.S. Army Futures Command Futures and Concepts Center. He graduated from the United States Military Academy at West Point and was commissioned into the Army in 1988. He has an M.S. in social psychology from Penn State University and an M.S. in national resource strategy from the Industrial College of the Armed Forces, which is now known as the Eisenhower School for National Security and Resource Strategy. His previous Road Map article, on the Synthetic Training Environment priority, appeared in the Spring 2020 issue.



SETTING UP

Spc. Cheryll Eguilos, left, demonstrates how to set up a Single Channel Ground and Airborne Radio System at Bagram Airfield, Afghanistan, in February 2018. Radio communication in Afghanistan is complicated by many factors, including an unreliable power grid, language barriers and low literacy rates. (Photo by Sgt. 1st Class Ben K. Navratil, 3rd Sustainment Brigade)

RADIO MODERNIZATION IN ANY LANGUAGE

How one Solider helped establish a radio modernization strategy in Afghanistan.

by Kathryn Bailey

Effective tactical radio communication is the one capability nearly every warfighter mission relies upon. Over the past few years, the Army has faced multiple challenges with establishing a robust and modern radio strategy for its Afghan National Defense and Security Forces (ANDSF) partners. Soldier and civilian experts must obtain requirements for radio procurements with unclear existing inventories. They must determine how a less-than-optimal infrastructure can support radio communications, or what radios have the right capabilities to establish communications across diverse and challenging terrain. Training inexperienced radio operators also presents a challenge, as does the real possibility of enemy interference.

As the U.S. military begins its drawdown in Afghanistan, it is even more crucial that it inserts modern radio communications and sustainment capabilities for the Afghan military, police and hospitals to help bolster security for the region. Capt. LaShaunte Trotter, assistant product manager for all air-to-ground radios, high-frequency radios and Link 16 terminals under the Program Executive Office for Command, Control Communications – Tactical (PEO C3T), deployed to Afghanistan early this year to help the ANDSF establish its radio modernization strategy across its Ministry of Defense (MOD), Ministry of Interior Affairs (MOI) and area hospitals, and by doing so, learned how to

mitigate some of the unique challenges associated with modernizing equipment in a foreign war zone.

BAILEY: As the officer in charge of ANDSF radio modernization, what did your assignment entail?

TROTTER: I deployed as the military deputy director for Combined Security Transition Command – Afghanistan (CSTC-A), Operational Sustainment – Information Communications Technology and Radio Program Manager. I provided direct support to the Operational Sustainment – Information Communications Technology director regarding the radio program. As the radio program manager, I was the officer in charge of a diverse team of contractors, senior government and military personnel from across the coalition charged with making strategic decisions to train, advise and assist senior Afghan leaders on the ANDSF enterprise radio requirements. Our main task was to assess the radio program as a whole, mainly focusing on the MOD, which is in charge of the Afghan army, or the MOI, which is in charge of the Afghan National Police, but our scope also included area hospitals, which required interoperable communications with the other two organizations. Throughout the assignment, we were charged with identifying current capabilities, future capability needs and determining a cost-effective and sustainable modernization approach.



COMMUNICATION STRATEGY

Capt. Lashaunte Trotter, center, joins members of the Operational Sustainment-Information Communications Technology section of CSTC-A radio program in March, 2020. Trotter deployed to Afghanistan early this year to help the Afghan National Defense Forces establish its radio modernization strategy program. (Photo by 1st Lt. Arianny Acosta, U.S. Marine Corps)

BAILEY: What did you encounter upon arriving in country for this assignment?

TROTTER: I was assigned to the Operational Sustainment – Information Communications Technology section of CSTC-A. This organization was responsible for radios, network infrastructure, spectrum management and cybersecurity. Upon arrival, I quickly learned I was joining a team of highly talented individuals, some who had been working in Afghanistan for 11-plus years supporting MOD or MOI. For an officer rotating in, this strong knowledge base was critical to the success of our mission.

BAILEY: How did you go about deriving requirements in a war-torn country?

TROTTER: If you think it’s challenging to derive requirements, procure radios and manage their life cycle in the United States, you can only imagine the challenges we faced in Afghanistan.

At the time, we had approximately 169,000 radios nearing their end of life; meaning, these radios were either obsolete, in need of significant repair or in need of modernization. To tackle requirements gathering,

we met with senior Afghan leaders and their respective IT departments in the Ministry of Interior Affairs and Ministry of Defense to identify the needed capability and discuss viable options.

A part of the discussion involved assessing the radios currently in their possession to ensure interoperability with future radios. Through this process, I determined ANDSF maintained an extensive list of radios maintained by many companies; it had no centralized radio procurement strategy. Another challenge with assessing the current inventory of radios was the effort to catalog equipment and component parts. Cataloging varied between the ministries of Interior Affairs and Defense, and as a result I spent a few weeks doing the necessary research to understand the radio systems in Afghanistan. This research yielded my ability to identify a baseline to procure new radios and sustain legacy systems. I then consulted with our team to execute a plan to meet the identified capability need expressed by ANDSF leadership.

As we looked at the organization as a whole during the requirements assessment, we focused on the makeup of

their personnel, the daily functions they executed and the radio assets necessary to perform their duties. That meant we were looking for radios to support very different mission sets that—for their military organizations—ranged from police patrols, to soldier checkpoints to special forces missions. Some organizations only required small handheld radios, while others required a more robust capacity and functionality.

BAILEY: What other challenges did you face working in Afghanistan?

TROTTER: A critical component to the mission was to train, advise and assist. While deployed, I learned there were differences in the execution of soldier task and supportability. The Afghan army power grid was less than optimal, so it was not uncommon for radio communication equipment to be unplugged in order to use electricity for personal reasons while on duty. This was not the norm, but something I had not encountered previously.

Another critical deterrent to our training efforts was illiteracy. We found the educated soldiers were often pulled from radio operating roles to serve in higher

levels of responsibility, which often left key radio communication positions to soldiers who may have had difficulty understanding training. There was a language barrier in itself, but this, coupled with the illiteracy issue only exacerbated the problem. We were fortunate that literacy and education were part of the ongoing mission within CSTC-A.

BAILEY: How did you work with the Ministry of Interior Affairs to derive requirements and conduct training for the hospitals?

TROTTER: We tackled the hospital radio requirements just like we did for the military and police—through our discussions with the respective senior ANDSF leadership to systematically gather requirements to ensure proper procurement. However, we had to quickly procure replacements for assets lost in the destruction of a hospital, which was attacked and destroyed prior to my arrival.

Our challenges mounted as we continued to encounter multiple disparate systems that were unable to interoperate. This situation was unsustainable; radio systems for the ministries of Interior Affairs and Defense had to be interoperable to ensure reliable communication between the many remote and mountainous locations.

BAILEY: What were the positive outcomes of your deployment?

TROTTER: After deriving requirements across all of the organizations, we executed a radio base station buy from a large radio vendor, which will support Ministry of Interior Affairs and Ministry of Defense requirements. We also procured man-portable, handheld and vehicle-mounted radios to meet high frequency,

very high frequency and multiband requirements to support the growth of the Regional Targeting Teams – Kabul 1399, i.e., 2020, which primarily consist of special operations troops in locations where the United States plans to maintain a presence.

BAILEY: This was your first war zone deployment. What are your takeaways from this experience?

TROTTER: Applying my radio acquisition experience in a foreign war zone provided me with an entirely new perspective. By discovering ways to collaborate with the ANDSF, we were able to develop a holistic approach to the ANDSF's radio communications needs, network infrastructure and general supportability. Like any deployed Soldier, you must set aside everything you took for granted working in the United States. Succeeding in different cultures with insufficient infrastructure, enemy interference, and language and literacy barriers is challenging, but this is what makes achieving the mission even more fulfilling.

For more information, go to the PEO C3T website at <http://peoc3t.army.mil/c3t/> or contact the PEO C3T Public Affairs Office at 443-395-6489 or usarmy.APG.peo-c3t.mbx.pao-peoc3t@mail.mil.

KATHRYN BAILEY is a public communications specialist for Bowhead Business and Technologies Solutions LLC, assigned to the Program Executive Office for Command, Control Communications – Tactical. She holds a B.A. in communications studies from the University of Maryland Global Campus, previously known as University of Maryland University College.



DIRECT NEGOTIATION

U.S. Soldiers attend a training session for the Afghan Army in Herat, Afghanistan, on May 2, 2019. The Army continues to prepare Afghan soldiers for imminent troop withdrawals, including addressing the Afghan National Defense Forces radio modernization efforts. (Photo by Jalil Rezayee)



DOUBLE CHECK

CCDC-AC engineers measure the removable outer tube sleeve for the XM808 during pre-fire checks during the limited user assessment in February 2020 on Fort Benning, Georgia. The combined, collaborative assessment with the 198th and PM CCS allowed for real-time feedback from Soldiers. (Photos by Darrell O'Steen, PM CSS)

TRAINING FOR SUCCESS

Project Manager Close Combat Systems and the 198th Infantry Brigade team conduct successful XM808 limited user assessment.

by Phillyp Lawson, Renée Bober and Darrell O'Steen, Lt. Col. USA (Ret.)

Out of the initial five days of firing during training, it rained every day, temperatures swung from the high 20s to mid-50s, and the range went into multiple cease-fires because of lightning in the vicinity of Fort Benning, Georgia. Experts from the U.S. Army Combat Capabilities Development Command Armaments Center (CCDC-AC), Project Manager Close Combat Systems (PM CCS), contractor Nammo Defense Systems and the 198th Infantry Brigade had arrived at the training event to conduct a limited user assessment on the XM808 Bunker Defeat Munition (BDM) with a removable outer tube sleeve.

Instead of pulling systems and resources into a traditional, stand-alone test, the XM808 integrated product team developed a plan to conduct a combined assessment where experts from CCDC-AC, PM CCS and Nammo would travel to Fort Benning and work with the 198th Shoulder Launched Munition Training Committee to collect firing data during the Infantry One Station Unit Training scheduled events. This plan, approved by U.S. Army Test and Evaluation Command (ATEC) and the U.S. Army Training and Doctrine Command (TRADOC) Safety Office, maximized resources and enabled the 198th to resume critical training while collecting the data necessary to validate that the addition of a sleeve would improve the XM808's durability.

THE CHALLENGE

The U.S. Army's infantry uses the M141 BDM shoulder-launched munition, a disposable one-shot munition designed to defeat masonry structures, earth and timber bunkers, and field fortifications. The bunker defeat munition system is managed by PM CCS within the Joint Program Executive Office for Armaments and Ammunition (JPEO A&A), at Picatinny Arsenal, New Jersey. It was rapidly developed to meet the evolving threat and was designated as a contingency-only weapon system and placed into inventory for forces engaged in conflict. The BDM is a phenomenal capability; however, the rapid development, procurement and fielding did

not include a training device for Soldiers to gain system proficiency before using the tactical system in combat environments. Following an accidental discharge of a tactical BDM in theater, a safety investigation determined that improved training via a dedicated training device would have mitigated the potential for an accident. The Army then developed the XM808 BDM 21 mm Sub-Caliber Trainer—with limited quantities produced—to become part of the Infantry One Station Unit Training. It was fielded to Soldiers at Fort Benning in 2011.

The XM808 trainer is unique in that it is reloadable and fires a practice training rocket whereas the tactical system is a single-shot, disposable weapon. The limited numbers of trainers were used to effectively train thousands of Soldiers. However, after several years of training, the outer tube began to show significant damage sustained from the repeated firing of the training rockets, which emit hot gases and burning particles. This created an unsafe condition for Soldiers during training, and in March 2019 the Army suspended XM808 live fire training.

PM CCS recognized that stopping training for any long period of time is unacceptable and immediately took action

to find a solution. The PM teamed up with the contractor, Nammo, to develop an innovative change to the XM808 Sub-Caliber Trainer as a solution to absorb and dissipate the hot gases and pressure to minimize outer tube wear.

THE SOLUTION

By May 2019, the XM808 integrated product team developed the removable outer tube sleeve to mitigate the damage to the XM808's outer tube. The sleeve consists of an aluminum nickel-terflon coated cylindrical shield, designed to safely disperse the hot gases produced during firing, to protect the bore of the outer tube and extend the life of the XM808 training device. The team conducted initial tests and performed comprehensive analysis in May and June 2019, validating the sleeve and ensuring it did not pose any safety or operational issues to the XM808's function. The government and contractor team worked closely with ATEC and the TRADOC Safety Office to determine that the sleeve was safe to implement in the XM808 trainer. Upon receipt of the determination, the XM808 integrated product team considered multiple courses of action to determine reliability, durability and service life of the sleeve. The team also knew it would need to incorporate updates to the equipment user

guide and the technical manual. The ultimate goal of these activities was to obtain a safety release of the XM808, which would include the tube sleeve as part of the complete training system, improve the system's useful life, and reintroduce the XM808 live fire events in Infantry One Station Unit Training.

PATH FORWARD

In September 2019, the integrated product team received approval from the Maneuver Center of Excellence and the 198th to collect firing data from the sleeve during training exercises. It worked with the 198th to maximize data collection without disrupting training, and the collaboration was critical to the success of the limited user assessment. It provided the data necessary to support an engineering change proposal for the sleeve design.

The collaborative assessment began in February 2020 with an overall objective to collect firing data; however, the team on the ground realized additional benefits from executing the data collection in conjunction with training. The shoulder-launched munition committee instructors began to gain a much deeper understanding of the XM808 systems as the technical engineers collected firing data, took measurements, documented findings and shared some of their observations with the Soldiers. And as relationships developed between the participants, there were often sidebar discussions on recommendations for how to improve the trainer design and operation in the field.

Sgt. 1st Class Carl Fitzwater, the Shoulder Launched Munition Committee noncommissioned officer in charge, said, "The [limited user assessment] is providing instructors with many new experiences from a variety of possible weapons malfunctions, increased maintenance expertise and overall capabilities of

The XM808 trainer is unique in that it is reloadable and fires a practice training rocket whereas the tactical system is a single-shot, disposable weapon.



READY, AIM, TRAIN!

The XM808 limited user assessment had many intangible benefits—information sharing provided engineers and instructors with experiences that may help improve their jobs. In a normal test environment, this kind of exchange would not have been available.

the XM808. These new experiences and skills they are learning from the engineers will greatly impact mission success for the future of OSUT [One Station Unit Training]...and Armywide.”

Furthermore, CCDC-AC experts from Picatinny Arsenal quickly saw their materiel solutions being employed in an operational environment in the hands of instructors and Infantry One Station Unit Training trainees. They gained an appreciation of how the user employs the system in a high-tempo, challenging

environment under all weather conditions. This event was clearly a “win-win” for everyone involved. Relationships between the product engineers and the instructors were established and enabled increased exchange of information between the technical experts and the Soldiers who employ the systems in an operational environment. The engineers were able to observe the system operationally employed and see how their design efforts provide warfighting capabilities. Additionally, the instructors gained more technical understanding and familiarity

with aspects of the system design to which they typically are never exposed. This information-sharing provided both engineers and instructors with experiences and knowledge that may help improve their respective job functions. These intangible aspects were not part of the initial assessment plan, but proved invaluable during execution.

More importantly, if not for the collaborative assessment, these relationships and exchanges of information would not have been realized in a typical test environment.

The BDM is a phenomenal capability; however, the rapid development, procurement and fielding did not include a training device for Soldiers.

Through execution of the combined assessment, the team was able to deliver increased training capabilities to the force while collecting not only the firing data to support the XM808 training device technical data package update, but also additional information to consider for future product improvement activities.

CONCLUSION

The limited user assessment culminated on March 20 with over 1,400 Infantry One Station Unit Training Soldiers firing 3,161 practice training rockets. In addition to accomplishing the primary objectives of the assessment, the teamwork among PM CCS, CCDC-AC, Nammo, ATEC and the 198th provided opportunities to improve the relationships between the materiel developer, the capability developer and the end-user while increasing their collective knowledge, which ultimately results in better training and acquisition activities.

“The [limited user assessment] has assisted in the re-branding of instructor proficiency and aided in a more in-depth understanding of the XM808 system,” Fitzwater said. The XM808 assessment success will enable a systems update that includes the removable outer tube sleeve as a component of the XM808, increasing the service life of the system as well as increasing the safety aspects during use. This product improvement activity ensures PM CCS is able to provide a reliable and safe system to support training in the years to come.

The XM808 assessment used existing 198th Infantry Brigade training resources to validate the sleeve and enabled resumption of critical training that also resulted in cost savings and reduced program schedule. Michael Franz, CCDC-AC’s lead shoulder-launched munition engineer, estimated the cost savings by executing the combined assessment and training to be approximately \$600,000. In answering the call to field the BDM, PM CCS reinforced the alignment of its shoulder-launched munitions with the Army modernization priority of providing Soldier lethality. And by improving the XM808 trainer, PM CCS also

prioritized training for munitions to ensure Army units are more dominant and lethal to win the nation’s wars in an ever-changing environment.

For more information, contact Phillyp Lawson at phillyp.c.lawson.civ@mail.mil.

PHILLYP LAWSON is the team lead for Shoulder Launched Munition within Product Director Combat Armaments and Protection Systems (PD CAPS). He is responsible for overseeing the planning and execution for the entire Shoulder Launched Portfolio, including programs like the BDM, anti-tank confined space reduced sensitivity munition and the Individual Assault Munition. Lawson has completed an M.S. in program management from the Naval Postgraduate School and a B.S. in mechanical engineering from Drexel University. As one of three team leads within PD CAPS, he assists in the coordination of all Shoulder Launch Munition actions for both PM CCS and JPEO A&A.

RENÉE BOBER is the Hand Held Signals Project Officer for PM CCS. She is responsible for executing the program budget, managing risk and providing direction and guidance to the integrated product team. Bober has over 12 years of government experience working for various entities at Picatinny Arsenal. Bober has an M.S. in engineering management and a B.S. in industrial engineering from New Jersey Institute of Technology.

DARRELL O’STEEN, Lt. Col. USA (Ret.), is a Millennium Corp. support contractor supporting PM CCS as the Maneuver Center of Excellence and Fort Benning field coordinator. He retired from the U.S. Army with over 26 years of experience as an enlisted combat engineer and armor officer. He holds an MBA from Baker College and a B.S. in business administration from North Georgia College. As one of five PM CCS field coordinators, he assists in representing PM CCS equities across the Maneuver Center of Excellence and the user community.

USER TESTED

USAMMDA works in theater to ensure warfighter health and safety.

by Jeffrey M. Soares

“This experience has allowed us to incorporate user input to inform fielding decisions—to make sure that we develop products that meet the warfighters’ needs.”

The U.S. Army Medical Materiel Development Activity’s (USAMMDA) project management offices have seen success recently with medical products and devices, ranging from tafenoquine—the first U.S. Food and Drug Administration (FDA)-approved prophylactic drug for malaria in nearly two decades—to the Laboratory Assay for Traumatic Brain Injury (TBI), which is the first-ever blood-based assay to detect instances of mild TBI. In current conflicts overseas, loud blasts are common because of the ease of creating improvised explosive devices, which are used by militants as roadside bombs to attack allied forces. The Defense and Veterans Brain Injury Center reports that since 2000, more than 417,000 service members worldwide have been diagnosed as having TBI, with an average of more than 24,000 cases occurring annually over the past decade.

In light of this, USAMMDA’s Warfighter Brain Health Project Management Office (WBH PMO) is charged with the development of diagnostic and treatment capabilities to aid military TBI patients. The effectiveness of the Laboratory Assay for Traumatic Brain Injury device has prompted the military to work closely with its commercial partners to develop a handheld version of the unit, which may be used by military medical personnel closer to point of injury on the battlefield. In addition, USAMMDA is continually searching for medical products and devices that may offer additional value in the detection of TBI.

In creating a tangible device, however, the USAMMDA team understands the importance of reiterative testing and evaluation to achieve a final product ready for fielding. A critical component of the standard testing process involves gaining feedback from frontline users who will be the recipients of these essential items. This task is overseen by USAMMDA’s product managers, who help to guide and expedite the process to ensure the welfare of our service members throughout the world.

UTILIZING THE USER

Army Maj. Sarah Sanjakdar, product manager in USAMMDA's Warfighter Brain Health Project Management Office, understands the value and necessity of including users in product development. In 2019, Sanjakdar completed a month-long special mission in support of the U.S. Central Command Surgeon Staff Assistance Visit to conduct a comprehensive assessment of two FDA-cleared TBI diagnostic devices, used to detect mild to moderate TBI, that were being tested in theater.

Sanjakdar said that although both products were commercially available off the shelf, the majority of clinical research had been conducted at trauma centers rather than in the field. Therefore, the user assessment was necessary to help determine if the devices would be useful for military medical personnel in combat.

"Questions that still needed answers focused primarily on the functionality and utility of these devices in an operational environment," she explained. "Specific questions pertained to the devices' ability to advance the current standard of care for triage, the devices' diagnostic accuracy in triage, and the environmental appropriateness of the devices, such as in wind, rain, dust, different light conditions, etc.—which are crucial factors that may affect sensitive diagnostic tools where triaging and clinical decisions are made."

Unlike typical controlled environments, where the majority of medical products are developed and tested, this U.S. Central Command user assessment provided critical feedback captured from the utilization of both devices in their intended environments, by medical personnel in theater.

"The mission lasted for 27 days, and we traveled around the U.S. Central



MANUAL INSTRUCTION

Maj. Sarah Sanjakdar, center, learned the value of seeking feedback on the function and usefulness of two FDA-approved TBI screening devices at medical facilities across the U.S. Central Command area of responsibility, including Kuwait, Iraq and Afghanistan. (Photos courtesy of Maj. Sarah Sanjakdar)

Command area of responsibility, including Kuwait, Iraq and Afghanistan," said Sanjakdar. "We visited several roles of [medical] care, ranging from Role 1 [at or near point-of-injury] to Role 3 [at the medical treatment facility], and we reached out to a total of 158 medical personnel, from medics at lower echelons of care to medical providers at the combat support hospitals."

Sanjakdar's user assessment was scheduled on very short notice, and she explained this was made possible by an effective collaboration between U.S. Central Command and U.S. Army Medical Research and Development Command leadership.

"We looked to determine the operational suitability of both devices, to learn how well they work in the field, and if they provide a practical solution to enhance our deployed medical personnel's current ability to assess TBI in theater," she said. "In other words, does either device give medical personnel more capability than they already have when it comes to assessing TBI in our wounded warfighters?"

Sanjakdar said she was assigned to run the initial equipping actions in the U.S. Central Command area of responsibility, and worked with the U.S. Army Rapid Equipping Force to move these TBI-detection devices into the hands of field medical

personnel. The Warfighter Brain Health Project Management Office was charged with determining the operational feasibility and suitability of two medical devices designed to identify those at risk for a brain bleed after head trauma. Sanjakdar was selected for the mission because of her medical, acquisition and operational background.

Taking charge of the program shortly after initiation, Sanjakdar quickly developed the plan for equipping and training the units, determined the necessary points of contact at the U.S. Central Command operations center, and designed the manner and approach for obtaining user feedback to inform the future acquisition strategy. She successfully equipped 17 units with 55 devices and conducted monthly progress reviews to receive feedback from the field.

Although Sanjakdar held teleconferences to provide the initial training and to answer preliminary questions from the user group, she said the only true way to perform a field evaluation is for a member of the project management office to meet face-to-face with those who will be using the devices.

“Seeing the product in use firsthand, you may notice something that the user may not necessarily think to convey,” she explained. “As a product manager, your perspective will differ from the user, so seeing the device in action will guide your understanding of how it fits into the operational setting. Being in the deployed environment will also inspire your work towards future products that may be a better fit for the end user.”

Sanjakdar truly believes in the benefits of incorporating this critical component into product development across the board, and she feels it is very helpful to build strong relationships with users at all levels of product development.

“While there, we wanted to conduct various interviews and surveys, so we brought in a fellow research psychologist from the Walter Reed Army Institute of Research,” she said. “He assisted with the gathering of data and is now leading the final analysis and report being generated on the outcomes of this data collection.”

Sanjakdar praises the ability of the Rapid Equipping Force to make possible these focused “small-equipping actions,” pushing critical medical products and devices to users for testing, which can help to ensure the health and readiness of our nation’s military personnel at home and abroad. Through this type of initial user assessment, these items are vetted in their intended environment,



REAL WORLD PRACTICE

Sanjakdar, left, observes and answers questions as medical providers use devices meant to detect traumatic brain injuries in patients at the Fenty Role 2 medical facility in Jalalabad, Afghanistan.

Although both products were commercially available off the shelf, the majority of clinical research had been conducted at trauma centers rather than in the field.

“Involving the operational end user is a key piece of medical product development that was previously under-represented.”

which can help illuminate both the benefits and the limitations of each.

THE NECESSITY OF FEEDBACK

“User feedback was very important, because we received some very interesting responses from medics that differed from providers, who have more training and experience, and may be much more critical of these devices,” said Sanjakdar. “The providers can compare their own abilities to what each device offers, and it will be a more stringent comparison than that from the medic, who may not have the same medical background to assess TBI as thoroughly as a trained neurosurgeon or neurologist.”

During her assignment, Sanjakdar met with nearly 160 medical personnel, which

included nurses, physician assistants and medics. She explained that her team specifically reached out to the entire spectrum of medical care as, inherently, there will be different perspectives at the different roles of care, and from the different types of caregivers as well.

In her role as a product manager at USAMMDA, under the umbrella of the USAMRDC and its higher headquarters, the U.S. Army Futures Command, Sanjakdar clearly understands the importance of being both “effective” and “innovative” in her team’s approach to product development. However, she also realizes the value of “agility” in this process, and recognizes the significance of failing early and responsibly, in order to learn from an unfavorable situation and parlay this knowledge into future success.

“From this single mission, our users have communicated to us what they would like to see, and it has helped to better define the requirements and path forward in the Warfighter Brain Health PMO,” she said.

Sanjakdar explained that the respective programs for both devices are now backtracking a bit, because the detailed feedback helped to identify previously unrealized user requirements. The information collected from the users in theater indicated a lack of operational effectiveness and suitability for both devices, although one of the devices may be accepted if it is improved based upon the findings.

“The WBH PMO has considered all of these key recommendations to help refine requirements for products to best meet user needs,” said Sanjakdar. “Our group is now conducting a more thorough market analysis to see what other products may be available to better meet the needs of the end users. Also, from the feedback we received, we are currently developing electronic tablet apps that could aid in the

DEPLOYED EXPERTISE

Sanjakdar, right, conducts training and assessment of FDA-approved TBI screening devices with the medics, physician assistants and providers at the Shorab Role 2 medical facility in Helmand Province, Afghanistan. She solicited input from 158 medical personnel during her four-week trip.





COLLABORATION

For Sanjakdar, center, the best way to nail down user requirements is to put devices in the hands of users.

return-to-duty decision in the deployed environment.”

“We’re trying to open up our aperture to see what else may be out there,” she added. “I think it’s necessary to ensure end-user input is a constant factor in product development, especially when we’re talking about military medical products. When you are out there in a deployed setting—on the battlefield—everything is dynamic, it’s always changing. In light of this, we must ensure that we, as DOD product managers, anticipate and adapt to changes in user needs, to develop and deliver the best possible products.

“Although we have general requirements, and gaps identified by our capability developers, it’s really those deployed medics, nurses, physicians’ assistants and doctors that will help guide and define exactly what it is we need to work towards delivering out there in the field—that’s why the end user should always be involved in the process.”

MOVING FORWARD

Traveling between 10 stops in less than four weeks to meet with product users, Sanjakdar admits the assignment was intense, but she says it was well worth the effort involved—particularly in support of our warfighters. In fact, she feels USAMMDA’s other PMO teams may now follow suit, finding opportunities to connect with their respective users as well.

“Involving the operational end user is a key piece of medical product development that was previously under-represented, but it has recently become more vital as the Army moves into its new multidomain battlefield operations concept,” said Sanjakdar.

“I believe this assignment has helped our PMOs restructure their programs around better defined user requirements,” she continued. “This experience has allowed us to incorporate user input to inform fielding decisions—to make sure that we develop products that meet the warfighters’ needs. You are less likely to develop

something they need and want, without their direct involvement and input.”

When it comes to trauma sustained in combat, Sanjakdar understands the importance of having the right product or device “in your bag” in order to save lives. However, she also realizes the “right” product or device can only be developed through the collaborative effort of key partners, both at home and abroad. While USAMMDA’s PMO teams work on their end to find effective solutions to satisfy the needs of our warfighters throughout the world, the involvement of product users remains paramount for success.

“This is something that I now do regularly, to build, maintain and grow those vital connections with our end users,” she said. “We have to bridge those gaps within and between medical and operational communities, to really just work as one team, together. That’s what this valuable assignment has provided for our WBH PMO, and hopefully all of our PMOs—and for me as a product manager.”

For more information on the work and mission of USAMMDA, please visit its website at <http://www.usammda.army.mil>.

JEFFREY M. SOARES is a senior technical writer and communications specialist with General Dynamics Information Technology, providing contract support as chief writer for the Public Affairs Office and Office of the Commander at USAMMDA. For the past 13 years he has served the U.S. Army Medical Research and Development Command at Fort Detrick, Maryland. He holds an M.A. in English language and literature from the University of Maryland and a B.S. in education and English from the University of Scranton.



LT. COL. CASSANDRA N. FORRESTER

COMMAND/ORGANIZATION:

Integrated Air and Missile Defense
Project Office, Program Executive
Office for Missiles and Space

TITLE: Product Manager, Integrated
Air & Missile Defense Hardware

**YEARS OF SERVICE IN
WORKFORCE:** 12

YEARS OF MILITARY SERVICE: 24

DAWIA CERTIFICATIONS: Level III in
program management and contracting

EDUCATION: M.A. in business administra-
tion, Central Michigan University; B.S. in
finance, Florida Atlantic University; associ-
ate's degree, Palm Beach State College

FACING CHALLENGES WITH CONFIDENCE

Lt. Col. Cassandra Forrester isn't afraid of a challenge. Growing up in Jamaica, where cooking was a big part of her family life, she was frequently shopping for ingredients, preparing dishes and planning meals with her aunt. At age 10, she decided she was ready to cook a meal on her own. Her aunt wasn't so sure. "She thought I would cut my fingers off," Forrester recalled. "She was so nervous, she said she couldn't watch." But in the end, the meal went off without a hitch. "It went really well," she said. "I'm a visual learner and I like putting things into practice."

Today, Forrester is the product manager for the Integrated Air & Missile Defense (IAMD) Battle Command System Hardware product office for the Program Executive Office for Missiles and Space (PEO M&S). At first blush, air and missile defense is a long way from making boiled green bananas in her family's kitchen. But Forrester encourages others to approach new tasks with the same confidence she did. "I have been fortunate to speak to newly accessed captains and majors at the Army Acquisition Center of Excellence course, as well as newly hired acquisition civilians," she said. "The advice that I mostly relay is, do not fear this new career path, ask questions, use helpful tools (AcqNotes, DAU [Defense Acquisition University] website, etc.), seek a mentor and know your ethical and legal boundaries."

She traveled a circuitous path to the Army Acquisition Workforce (AAW), first enlisting as a 92A logistics specialist in 1996 and later commissioning as an ordnance officer via Officer Candidate School. She first heard about the AAW during a deployment to Iraq, and the timing was perfect. "I loved my Army family and wanted to continue serving, but I needed to find a role that was a better fit" personally and professionally, she said. When she learned about the AAW, she saw it as a great opportunity. "I was captivated by the level of responsibility, autonomy and professional growth possible in the Army Acquisition Corps. I was excited about the opportunity to remain in the Army and still grow my business acumen."

Her first acquisition position was as a contracting specialist and contingency contracting officer, and she found her previous experience to be quite helpful. "I have logistics management experience and planning, tracking and reporting experience," she said. "I've worked in ordnance maintenance and I ran an ammunition supply point as a lieutenant in Okinawa, Japan. Risk planning, issues tracking, these are all skills I developed when I was enlisted and as an ordnance officer." Now, Forrester recognizes these as some of her most important skills and attributes.

At PEO M&S, she is responsible for the development, procurement, fielding and life cycle management of \$3.8 billion in air- and missile-defense systems. Those items include legacy Air Defense Airspace Management; Rocket, Artillery

and Mortar Warn; and IAMD Battle Command System components. She also leads a team of more than 150 government and contractor personnel. It's a complex product within a complex program. Put simply, "This is supposed to be the mission command and control node, or system, that allows all Army air- and missile-defense systems, existing and future, to be able to communicate with each other," she explained. "That is a tall order."

So how does she approach the task? "Relying on the program management fundamentals," Forrester said. "Risk management, all those processes, just making sure I rely on the fundamentals and stay in synch with all stakeholders, whether it's the G-8, the G-3/5/7, the requirements or capabilities manager. I have to bring it all together to ensure that

what I'm providing does meet the expectation. It's a dance."

If asked to hire her own replacement, Forrester said she would look for someone with the same balance of skills that she has now, but with an added focus. "Communication, written and verbal, is really necessary in this particular job," she said. "The product we have is the only ACAT [Acquisition Category] 1 Army air-defense program being managed at the OSD [Office of the Secretary of Defense] level, so communicating with our stakeholders is very important." In addition, it's important to understand the interdependencies, how the system impacts people on a tactical and operational level, versus on the strategic and political levels. "You have to understand how it all fits together," she said. "You can't have tunnel vision. If

"Do not fear this new career path, ask questions, use helpful tools, seek a mentor and know your ethical and legal boundaries."

this schedule slips, what does that mean to the Soldier? It's crucial to see and manage those interdependencies."

The most significant lesson she has learned through the course of her career, though, is about the importance of family. "Family is most important," she said. "I apply this same philosophy at work." Undeniably, during the COVID-19 pandemic, this lesson carries a new weight. When the novel coronavirus began making headlines around the world, Forrester was quick to take action. "I knew my workforce well enough, that even prior to the stay-at-home order, I was able to have some of my high-risk folks start teleworking," she said. "Family comes first. When I built that plan, I took into consideration immediately who had young kids, who had underlying conditions, and other factors. Without them, I can't do my work."

Forrester feels that she has two families. "One that I work with, and one that I go home to," she said. Regarding both families, "I am motivated, driven and humbled to serve for their happiness."

—ELLEN SUMMEY



FAMILY FIRST

Lt. Col. Cassandra Forrester has two families: One at home and one at work. Their collective safety and well-being is paramount. Pictured here is her family at PEO M&S, from left: Mark Bowes, Jordan Christensen, Billy Parsons, Jimmy Beach, Forrester, Roger Potter and Jessie Rainwater. (Photo courtesy of Lt. Col. Cassandra Forrester)



Illustration by elenabs/Getty Images

ON A DIME

Contractors have pivoted, practically overnight, to keep in step with DOD throughout the ongoing coronavirus pandemic response.

by Ellen Summey

The federal government usually moves like a freight train—it's big, it's heavy and it doesn't like sharp turns. But the Army and its partners in industry have proven this year that they can turn on a dime if needed. In March, when COVID-19 first became part of our collective awareness in the U.S., the Army's civilian and contractor workforce largely occupied offices in federal buildings across the country and around the globe. With the DOD mandate to "protect the force," Army senior leaders made the rapid shift to maximum telework, essentially switching tracks at full speed.

"Our mission of delivering materiel capabilities to the warfighter is accomplished by the total force, including military, civilian and defense industrial base partners," Army Acquisition Executive Dr. Bruce D. Jette said in a memo dated March 24. "Undoubtedly, the impacts of the nation's emergency response to COVID-19 have been acutely felt by contractors and vendors providing services and products to the Army," he said. In the memo, Jette asked contracting officers and program managers to encourage telework where possible to minimize the health risks to the workforce. "The resiliency and strength of our team is a national asset and critical to the Army's ability to meet mission requirements around the world," he said.

So what has changed for DOD contractors in 2020? It depends on whom you ask.



**ERIC STRAUSS,
CONNECTED LOGISTICS**

STAYING ON TRACK

Eric Strauss, director of business development at Connected Logistics, said some things have changed but much remains the same. The company, which is based in Huntsville, Alabama, provides logistics, systems engineering and program support to DOD and the Army, as well as other government contractors. "For us, so much has remained the same," Strauss said. "I think it's a testament to the flexibility and adaptability of contractors and small businesses in general. Most of our folks frequently work off-site or from a home office or from a client site, so in many ways, we've continued doing that and it's worked very well."

But there are some new challenges to telework in 2020. Strauss and his wife have two school-age children. Though they're both very used to working from home, "What we're not used to is having kids run around and not be occupied during the day," he said. "So that was certainly a big change." Strauss and the company's other leaders wondered how to keep employees focused on the mission amid all the distractions. "Things like trying to work through distance learning [with a child] when you've got meetings and phone calls and interviews and client things going on ... we are much more focused on the outcomes and the deliverables and not nearly as worried about what time of day someone is on their computer. What we've realized, frankly, is that we're just as productive, if not more."

In fact, Strauss said Connected Logistics has submitted more proposals and received more contract awards since March than at any other point in the company's history. "This change is not only going to drive our behavior during whatever the remainder of COVID is, but for a long time in the future," he said. "We don't need to be sitting side by side looking at the same screen or looking at the same projection on the wall to be productive. We can be just as effective as anywhere else when we are all flexible and available as needed."

Looking ahead, Strauss hopes that remote work arrangements will become part of DOD culture. "If we as a company have the flexibility to hire more remote employees for DOD contracts, then we can ultimately offer a better product to our clients, often at a lower price." That's not just idle speculation—Connected Logistics has contracts with the Defense Logistics Agency, staffed by a remote team that is spread across the country. "We've got a program manager who is great in that environment, working with people across time zones, and it's a very well-oiled machine," he said. "That flexibility allowed us to recruit, hire and retain the most qualified people for the job, not the ones who happen to live closest to the office."

"We're in the process now of relocating the entire company to a new office that is designed around both maximum spacing for people and ventilation."



MEGAN LACY & CORBIN HENNEN
LUMINEYE

CHANGING DIRECTION

For Megan Lacy and Corbin Hennen, co-founders of the xTechSearch 2.0-winning company Lumineye, the major change has been travel. "We traveled a lot in 2019," Lacy said, "between all the testing and the xTechSearch competition and working with users outside the DOD. Pretty much all of that has halted for now." The company is focused on hardware—its bread-and-butter product is a handheld sensor that can identify and locate people through walls. Developing and testing hardware requires in-person, hands-on work that doesn't function well in a remote setting. "Since we're a small team, we can distance a little bit better and there's less risk of people gathering together," Lacy said. "But developing hardware from home is hard because that's a very physical thing." The team had to create schedules and routines for bringing hardware home, so that others could access the devices when needed. "I think we've adapted pretty well," she said.

Hennen said the team has also adjusted its product demonstrations. "As an alternative to travel, we've gotten a lot better at doing remote demos," he said. "That is not trivial when you're trying to demo through-wall sensing, because it's really difficult to capture that." But Lacy and Hennen also see that as an opportunity to make their business more scalable. "You don't necessarily need to spend the time, money, et cetera, to go fly out to places for an initial meeting," if you can make those introductions remotely, Hennen said.

Overall, Lacy said she has been impressed with DOD's response to COVID-19. "I know that for a lot of government jobs, you can't just bring your laptop home. There are a lot of restrictions there," she said. "I've been relatively impressed and pleasantly surprised with the Army's transition to maximum telework." Depending on the changing community health conditions and the progress toward a vaccine or effective treatment, Lumineye

“Having your kid run around in the background of a team conference call might be considered inappropriate. Now it’s totally acceptable.”



**ERIN HORRELL,
INTELLIGENT WAVES LLC**

will have to address some additional challenges. “I think a lot of stuff is going to be business as usual, but there aren’t as many testing opportunities,” Lacy said. Hennen agreed, and said the company has tried to bridge gaps by focusing on its organizational culture during this time of uncertainty. “We’ve done a lot of culture building, trying to elaborate on what we stand for and what we value, over the last couple of months,” he said.

MAINTENANCE REQUIRED

Erin Horrell is chief growth officer for Intelligent Waves LLC, which provides IT solutions to both public and private sector clients. The company is in talks with the Army about its Hypori platform, a secure means of accessing military information systems with a personal mobile device. Despite the company’s emphasis on mobile communication, it was not a primarily remote company before

COVID-19. Horrell said she’s seeing signs of strain among her team members. “Telework is beginning to have an impact, I believe—at least in my team.” She runs sales organizations, where many of the staff are extroverts by nature. “The very definition of an extrovert is meeting and greeting and crowds and people,” she said. Now “they’re not able to do that. That’s becoming problematic for them, I think mentally and professionally.”

Horrell said the company is also looking for ways to reduce the stress of constant video meetings and the added interruptions at home. “It is causing challenges. We can hear. We see things. I mean, everybody’s on video,” so she is requiring her staff to take breaks, and she recommends others do the same. “Block time on your calendar. Go outside. Take a walk. It’s simply not healthy or sustainable to sit in front of a computer for 10 hours a day, five days a week.” Her staff has been

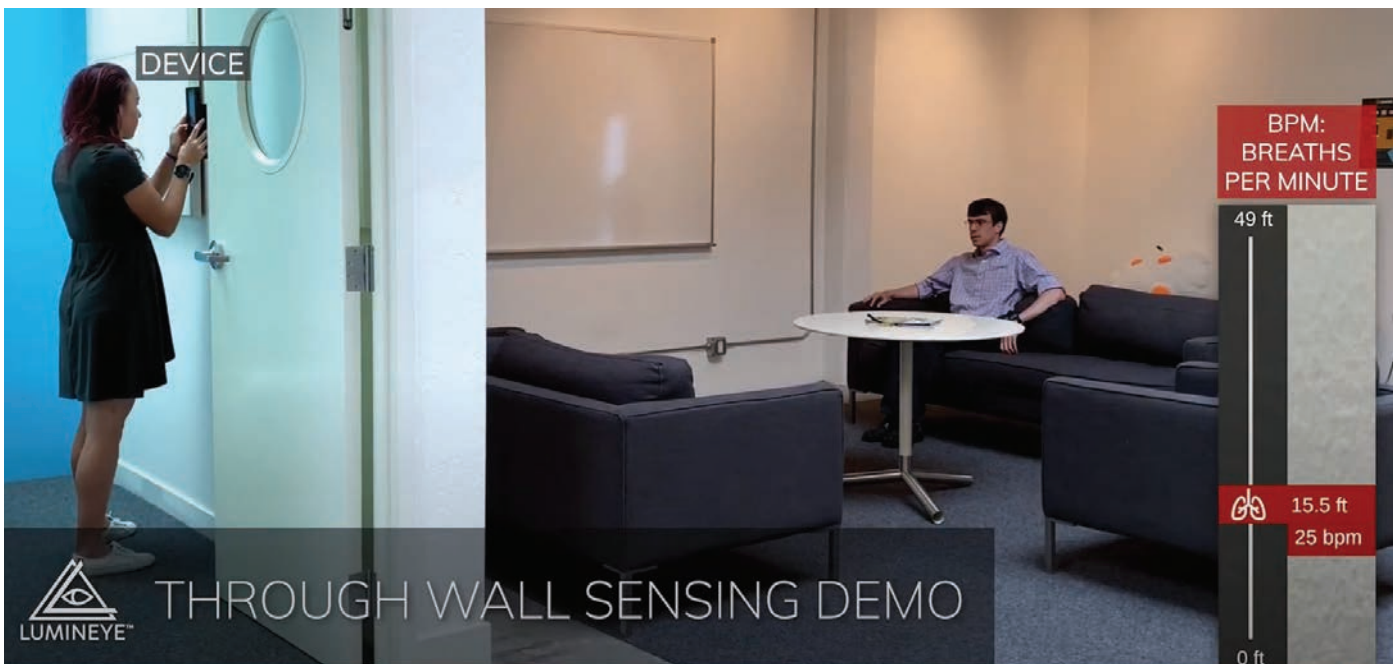

SEEING THROUGH WALLS

A screen grab from Lumineye’s “Through Wall Sensing Demo” video. (Photo courtesy of Lumineye)

working longer hours, but she has seen teammates looking out for one another and trying to share the load. “I’ve seen a lot of people covering for others and taking things off other people’s plates, especially to accommodate the individuals with children at home—everybody is giving a helping hand.”

Teamwork makes the dream work, as the saying goes, and Horrell is looking for ways to team with DOD more effectively during the pandemic. From a sales perspective, she said the company craves more of the communication that would normally take place during conferences and industry events. “DISA [Defense Information Systems Agency] does a very good job every year of doing a virtual forecast to industry,” she said. “The Army has kept up those annual virtual events, but it’s different than the kind of engagement that happens at conferences. I think more interaction from the acquisition community would be helpful in terms of new initiatives, new requirements.” For example, she’s curious about COVID-19’s impact on the Army’s network modernization and systems migration plans. “Fill in the blanks for us,” she said. “We kind of feel in the dark.”



TOBIN FISHER,
VANTAGE ROBOTICS

AN OPERATIONAL OVERHAUL

Tobin Fisher is the CEO of Vantage Robotics, which is developing intelligence, surveillance and reconnaissance drones for the Army. For his company, “an awful lot” has changed. “I think the COVID pandemic is a real test for every company and their ability to adapt in the face of such massive changes in how we actually do business.” And telework is just the tip of the iceberg. “We also have been doing a lot to change our office,” he said. Wearing masks was “a no-brainer,” but they’ve also created logs of everyone who has been in the office, tracking when they were present and who else was there at the same time. They started with

“I think it’s a testament to the flexibility and adaptability of contractors and small businesses in general.”

temperature checks for staff, and then added pulse oximetry—a test used to measure the oxygen level of the blood—and sniff tests—an exam that checks how a person’s diaphragm moves—for anyone entering the building. The goal is to have many “indicators of potential infection, as well as the ability to do contact tracing of anybody who’s been in the office at the same time, ever.”

As a next step, the company decided to find a better office space. “We’re in the process now of relocating the entire company to a new office that is designed around both maximum spacing for people and ventilation.” It’s much larger and is being renovated with safety in mind. “One whole wall of the office is all roll-up doors. The intent is to maintain many, many, many air changes an hour. As far as we can tell, the best research shows that the best way to prevent COVID infection is to avoid stagnant air with lots of people in it.” Fisher sees this new office as crucial to the company’s continued success. “Our expectation, our plan is that these limitations will be there for the next 12 months and we’re planning accordingly,” he said. “We need the ability to run operations and run manufacturing. And that would be much more challenging with an office that can only have 25 percent of the team there at a time.”

One positive result of extended telework, Fisher said, is that his team is closer than ever. “Previously, having your kid run around in the background of a team conference call might be considered inappropriate,” he said. “Now it’s totally acceptable. I think we’re all getting to know each other a little better and that’s a good thing. I think it makes us more cohesive as a group.” And the timing is good because Vantage Robotics has been growing. “We’ve nearly doubled the team since the lockdown started,” he said. “Bringing new team members on and maintaining that same sense of cohesion across the team is a real challenge.”



“It’s simply not healthy or sustainable to sit in front of a computer for 10 hours a day, five days a week.”

THE INDISPENSIBLE EYE

Vantage Robotics’ Vesper short-range reconnaissance vehicle is designed to be inexpensive, rucksack-portable, with vertical take-off and landing ability. The company says it will provide platoons with a rapidly deployable intelligence, surveillance, and reconnaissance capability to provide situational awareness. (Photo by Vantage Robotics)

Despite the obvious hurdles, Fisher said his team has refused to let the pandemic stand in its way. “We’ve won \$7.2 million in R&D [research and development] contracts since the COVID lockdown. We’ve been ramping and expanding production. We continue delivering units to customers,” he said. “The first priority will always be keeping everyone safe, but the team has really risen to the challenge of getting the job done amidst these new constraints.” And he sees DOD as a responsive and reliable partner in this entire process. “I think DOD has been really effective in this transition,” he said. “Their willingness to continue to move ahead with our key contracts during this time ... those financial resources are certainly critical to us.” And he understands the challenge of drastic change

for such a large organization. “It’s much, much more challenging to be nimble as a million-person organization than it is for us as a 20-person organization,” he laughed. “I really respect how they’ve managed that.”

CONCLUSION

The Army relies on its partners in industry, and they are determined to deliver. Government contractors provide critical products and services for our nation’s warfighters, supporting their ability to prevent and respond to threats around the world. Through the unprecedented challenges of the COVID-19 pandemic, the ingenuity and flexibility of DOD and its partners in industry have proven that sometimes even a freight train can turn on a dime.

For more information about resources for companies navigating the complexities associated with the coronavirus, visit the DOD Office of Industrial Policy website at: <https://www.businessdefense.gov/coronavirus>.

ELLEN SUMMEY provides contract support to the U. S. Army Acquisition Support Center at Fort Belvoir, Virginia, as a writer and editor for SAIC. She holds an M.A. in human relations from the University of Oklahoma and a B.A. in mass communication from Louisiana State University. She is certified as a Project Management Professional and Change Management Professional, and has more than 15 years of communication experience in both the government and commercial sectors.

DEVIL IN THE DETAILS

The proposal development process is a huge and sometimes expensive undertaking. Winning business can dictate whether the company can stay in that line of business. (Image by Getty Images)



BEEN THERE, DONE THAT GETTING TO A WIN

| How industry responds to a request
for proposal.

by Dr. Charles K. Pickar

The U.S. defense industry and DOD communicate with each other in many ways, but none is as significant as a request for proposal (RFP), nor carries such high stakes. RFPs are long, tedious, confusing and filled with legalese, which is not a very good way to communicate. But to paraphrase Winston Churchill, an RFP is the worst form of government-industry communication, except for every other form of communication.

In some of the acquisition classes I teach at the Naval Postgraduate School (NPS), I use an RFP as a catalyst for term group projects. Students are divided into teams and role-play as government program management offices and contractor companies. Actual RFPs provide NPS students an opportunity to think about the way we communicate with the defense industry and to learn project management. Ultimately, they can compare their thoughts to what is actually happening in the contract. That's because the tasks usually required of a contractor to respond to an RFP closely mirror the tasks necessary to plan and manage a project. These tasks range from developing a statement of work to defining a work-breakdown structure, to building a schedule, conducting a risk assessment and more.

These activities also feed the cost estimation process, a critical factor in ensuring a competitive proposal. And, of course, quality control through reviews is necessary at every step, often many times, to make sure the contractor's proposal is perfect. Once the contractor's technical, pricing and management issues are defined, the proposal design teams, artists and professional proposal writers step in to edit and make the proposal the document you see the day after it is delivered. Understanding this process, how we in government cause proposals to be submitted, is essential to understanding the defense industry.

THE FOUR METRICS

Four key metrics drive that industry: orders, sales, EBIT and cash. For those unfamiliar, EBIT stands for earnings before interest and taxes, a measure of the company’s performance before accounting for the costs that influence profit. Those four metrics drive the private sector, and they’re what drives defense contractors.

Order comes from the result, with any luck, of the proposal the contractor submits. Orders are new business and become backlog for a company, and they represent its health and future. In the case of publicly listed defense-focused corporations, orders are one of the fundamental measures stock analysts watch to determine whether they will buy or sell.

Sales happen when a product is delivered and accepted. Acceptance triggers typically some kind of payment, which directly influences that last category—cash.

EBIT levels the market, letting everyone see how effective and efficient a company is at making money.

Cash represents cash flow, how much comes in and how much leaves. Just like your household, businesses must have more money coming in than going out to survive.

A contractor program manager’s (PM) career turns on how well he or she can meet targets set on these goals. That PM is responsible for the deliverables required in the RFP. Orders keep happening when government customers are happy with what the company delivers and how well the government rates them in

TABLE 1

TEAM	PURPOSE	HAPPENS
BLUE	Capture plan and win strategy for the opportunity.	Pre-RFP
BLACK HAT	Business intelligence: the competition, a projection as to their technical solution, and SWOT perspective (strengths, weaknesses, opportunities and threats).	
PINK	How the proposal team will comply with the RFP. Also, a review of the win strategy to ensure proposal compliance.	
GREEN 1	Price and cost estimate reviews. Also reviews the “price-to-win,” an assessment to predict the competitors’ prices based on business intelligence.	
RED	The most critical review. This is a full-dress rehearsal of the entire proposal for compliance, focus and message. Usually performed with a combination of internal and external experts.	
GREEN 2	Final price and cost review. The review also includes discussion of the independent cost estimate usually performed by a designated expert within the company.	
GOLD OR SIMPLY FINAL REVIEW	Final executive approvals focusing on RFP compliance, price and risk.	

COLOR TEAMS

There are frequent reviews over the development of a proposal, usually labeled by color to indicate the type of review. Here is a generic example of a color team agenda. (Graphic by U.S. Army Acquisition Support Center)

the Contractor Performance Assessment Reporting System, along with other relevant data.

While all these metrics are essential to staying in business, the orders metric is the one that leads the process and often means the most to the people working there. Landing new contracts and building an orders backlog is how a company grows. And, in our economy, companies must always grow or they are destined to go out

of business. Being able to win a competition requires significant, coordinated actions from identifying an opportunity to developing a solution to writing it up in something we call a proposal.

IT ALL STARTS WITH BUSINESS DEVELOPMENT

Among the many jobs I had in the defense industry, some of the most interesting were working in the business development area and responding to proposals. Business

Industry wants to work with us—and no, they don't expect any unfair advantages.

A basic rule of thumb states that if the release is the first time you hear of an RFP, then there's no point in competing. In the industry, the earlier they start, the better.

development discovers, tracks and eventually wins potential business for contractor companies. Defense contractors must consistently book new business (orders)—win competitions—to stay in business. They also must “keep programs sold,” that is, make sure the contract and quantities contracted don’t get changed or canceled by DOD or Congress. This means business developers must have an in-depth understanding of warfighter issues and position the company to solve those problems. That’s why the industry is always interested in former military personnel. Former Soldiers, Sailors, Airmen and Marines provide a perspective most industry people don’t have—an understanding of the culture and the way the systems will be used.

“Capture” is a defense contractor-unique term. It is the process contractors use to concentrate on winning the weapon system development business. These front-end activities are critical to developing a winning proposal in response to an RFP.

THE RFP ROAD MAP

Writing a proposal requires the contractor to analyze the RFP to thoroughly understand what the government wants so they can develop a technical solution. The only purpose of a proposal is to persuade the government that their answer is the best choice. They follow a disciplined, formal process to produce a convincing document according to strict rules and within restrictive deadlines. And, they often spend significant amounts of money on engineering, labor, travel, intellectual property and other costs to deliver a competitive proposal.

They usually have professional in-house artists to create the graphics and will even hire voice and acting coaches should the RFP require an oral presentation. They may also employ a company that specializes in developing and managing proposals. If a contractor commits to responding to an RFP, they are in it to win it. I have worked on small proposals for which the company spent less than \$2,000 and proposals that cost over \$500,000 and, in some cases, even more.

GO WITH THE FLOW

Different companies have different processes, but there is a universal flow of in-house events from the time an RFP is released to the submission deadline. Every company uses this typical flow from prime contractors to their subsystem, component and parts suppliers. The steps include gate reviews to provide company leadership an assessment of the probability of winning, analyzing the RFP, developing and writing the solution, plus a series of quality reviews to ensure compliance, quality and profitability. “Color team” reviews address compliance and quality. Gate reviews address profitability and the probability of winning and culminate in a bid or no-bid decision. Assuming the company decides to bid, the initial proposal activity, examining the RFP, is to communicate what the government wants to the proposal team.

It is important to note that while the RFP release starts the formal proposal process within a company, several critical pre-proposal activities happen before RFP release. These contractor activities include engaging the warfighter and PM office and gathering business intelligence for competitive assessments, to name a few. Of these, developing a win strategy is often the most challenging. A win strategy is conceptually simple—the plan for winning the competition. It requires a clear-eyed appraisal of company strengths and weaknesses, whether a proposed solution would address all the government’s issues, an assessment of the competition and an evaluation of what a win or a loss might mean to the company.

SHREDDING THE RFP

Analysis of the RFP, the first phase in the proposal process, is often referred to as shredding the RFP because it entails literally taking the RFP apart to identify requirements, instructions, evaluation factors and deliverables. Once the shred is complete, the RFP is broken out by sections into smaller parts for assignment to the proposal team.

There are software applications that not only automate the process but also assign, schedule and track writing tasks. Decomposing or shredding the RFP gives the proposal team insight into the specifics the government seeks, and results in a rule book, or compliance matrix, to ensure that the team is addressing everything the RFP requests.

Finding all of the government “asks” in an RFP is challenging because deliverables and requirements are frequently dispersed throughout the document. My students, even those who have worked on RFPs, are often amazed at how hard this job can be. The shredding process provides the key players of the proposal



MARATHON, NOT A SPRINT

The Red Team simulates the government evaluation board process, identifying problems that need improving. This is the big event for developers and is critical to the success or failure of a proposal. (Image by Getty Images)

team, the proposal manager and the “book bosses” of the necessary volumes—cost, technical, management, past performance and others—what they need to get to work.

GETTING DOWN TO PROPOSAL BUSINESS

Once the RFP is released, the proposal manager assumes control of all activities associated with the solicitation. If developing the proposal is like a system development, the proposal manager is the PM. The proposal manager’s job often goes beyond PM-type activities, though. Large companies frequently have a full-time proposal manager and dedicated

workspaces, including secured areas, if necessary.

The proposal manager in a large company is the go-to resource manager, but there is often another senior person appointed as proposal manager as well. That person could be someone from the business development organization, an engineer or even a senior executive, depending on the person’s familiarity with the customer and the solution, as well as the importance of the submission. The significance of the RFP to the company is recognized well in advance of any business development work being done. A basic rule of thumb states that

if the release is the first time you hear of an RFP, then there’s no point in competing. In the industry, the earlier they start, the better.

SIMPLE TO SUBLIME

RFPs range from the routine task-order type work—small-dollar but quick-response activities—to complex RFPs for major weapon systems. Given the structure of the U.S. defense industry today, those large RFPs often determine not only which companies will win, but those that will stay in that line of business. For example, when Lockheed won the F-35 contract, it also became the sole developer

of fifth-generation fighter aircraft. While Boeing is still building older, fourth-generation F-15 and F-18 aircraft, Lockheed, with a trained workforce and already-developed intellectual property and software, is uniquely positioned to be ready for a sixth-generation program should one develop. RFPs for these generational-type systems are often designated as must-wins for a company because a loss has such far-reaching potential business effects. Must-win proposals have virtually unlimited budgets and are carefully managed. (Whether this is a good thing for the government is another column.)

The proposal manager backward-plans a proposed delivery schedule based on the submission due date. Planning estimates are measured by the individual writer in pages, by section, by day. Proposal sections are combined to construct volumes (or books) with the overall number of pages set by Section L of the RFP. (Section L is the part of the RFP that contains instructions, conditions and notices to offerors or respondents.) Given the relatively short turnaround time between RFP release and submission of proposals, actual solution development must start early in the pre-RFP process. RFP turnaround times are measured in weeks, or maybe a month or two.

Solution development is executed like an actual project, only accelerated. Costs and schedules must be estimated. Risk assessments are ongoing. Proposal team members are gearing up for 12- to 16-hour days to stay on schedule. The crunch can be even worse when the government releases an RFP shortly before a major holiday.

WRITING THE FIRST (AND THE SECOND AND THIRD ...) DRAFTS

Writing the proposal is the nuts and bolts of developing it. Experts across the proposal sections are sequestered in the proposal development center or another dedicated space so they can focus on the writing as well as collaborate with other team members. Speed is of the essence. Bigger, more complex proposals often require people from outside the central organization to join the team, which complicates this process.

Four key metrics drive industry: orders, sales, EBIT and cash.

Key initial activities include developing and approving storyboards and identifying graphics, while always checking the rules in Section L of the RFP. The prime directive for the team at this point is to get something on paper for editing and revisions, and the pressure is significant. Everyone knows that the best proposals, much like academic work, come from constant revision.

Short timelines, tension and the complexity of answering RFPs often cause real problems on a team. I have worked on proposal teams where we had to physically separate engineers after disagreements on the finer points of the technology. An oft-repeated phrase around the proposal center goes, “Tell them what *they* (the government) want to hear—not what *you* want to tell them.” That is harder to do than it sounds. Hours turn into days into weeks and so on. For the many people writing a proposal, their world becomes focused on two things: writing deliverables and making sure these products conform precisely to requirements stated in the RFP.

QUALITY CONTROL AND A METRIC FOR PROGRESS

Whatever the differences among different companies’ proposal processes, most use a series of reviews, generically referred to as color teams, because of their designation. Part of the planning process is establishing and scheduling the color teams. While varying from company to company, teams execute a series of events shown in Table 1, Page 142.

A Red Team review is *the* big event for proposal developers. It is a complete review of the technical and management volumes from the government evaluator’s perspective. The Red Team simulates the government evaluation board process as best it can, and its end state is the identification of issues the team believes require improvement. Once the proposal has gotten past the Red Team, the pressure to get it fixed, completed and out the door drives everything the proposal manager does.

DELIVERED, AT LAST

The last step (which is actually a series of steps) before a proposal can be delivered is to gain the necessary internal approvals. The approvals range from the technical solution to the cost. Most proposal managers engage the company leadership throughout the process because no one wants to be surprised.

While the proposal manager is finalizing the proposal, functional managers are meeting with the company president or their business unit brass for final approvals. If the proposal manager is lucky, this last approval meeting occurs well before the required



submission date. However, the many moving parts, people, processes and decisions can push these final meetings to just hours before deadline.

Finalizing the proposal means putting it into production. In ways reminiscent of publishing a newspaper or book, the editing process—making sure graphics are what they should be, where they are supposed to go, with captions that explain what they are supposed to explain—is a huge undertaking. A proposal must be perfect because it represents what that company can do. If it is professional and without flaws, it can convey the idea that here is a company that is professional, detail-focused and competent. Conversely, errors in a proposal convey the opposite. Finally, the government will reject any proposal not in compliance with the instructions in Section L of the RFP. While the stakes are very high throughout the process, impeccable delivery is crucial.

Once the proposal manager gains final approval, the proposal is delivered per the RFP instructions. At this point, most of the proposal writers are finished. However, there remains a small core of people who will stay in the proposal center, ready to address any questions coming from the government evaluation board. Keeping these people together is crucial because they have the information, understand the solution and, most importantly, can

explain what they meant should the government need clarification. Depending on the issues, this group may be tied down for many weeks.

FINAL THOUGHTS

The defense industry wants to show the Army that they get it, that they can do the job that needs doing. By the same token, the Army wants the best proposals from the best contractors. That sets up a potential win-win situation. The defense industry must make a profit to stay in business, and we need quality weapon systems that ensure mission accomplishment.

Winning proposals aren't written in a vacuum. The proposal process for every company in the industry is predicated on understanding what we in the government want, what we want it to do, when we want it and how much we are willing to pay. We make the rules. Industry wants to work with us—and no, they don't expect any unfair advantages. They are probably more aware than we are of the law and work hard to prevent any illegalities.

For industry, communication is critical to this process of proposals. We should always keep in mind the value of communicating with the industry because the RFP is a means of communication. You would be surprised at the value you can get from engaging your industry partners.

FINAL DELIVERY

Once the proposal manager gains final approval, the proposal is delivered according to the RFP instructions. (Image by Getty Images)

For more information on RFPs, go to: <https://www.acq.osd.mil/dpap/ccap/cc/jcchb/html/Topical/rfps.html>, <https://www.acquisition.gov/content/15203-requests-proposals>, https://www.sba.gov/sites/default/files/2018-02/proposals_workbook.pdf or <http://acqnotes.com/acqnote/tasks/request-for-proposalproposal-development>.

*DR. CHARLES K. PICKAR is a senior lecturer at the Naval Postgraduate School (NPS) in Monterey, California, where he teaches program management, acquisition, and systems engineering in the Graduate School of Defense Management. He has more than 30 years of management and research experience, including leadership positions at the Johns Hopkins University Applied Physics Laboratory, Science Applications International Corp. and Lockheed Martin Corp. He holds a doctorate in business administration from Nova Southeastern University, an M.S. in systems engineering from The Johns Hopkins University, an M.A. in national security affairs from NPS and a B.A. in business from the University of Maryland. He is a graduate of the U.S. Army School of Advanced Military Studies. The author's last *Been There, Done That* column was "AI Needs Data," in the Summer 2020 issue.*

INTELLIGENT CONTRACTING

| New technology and business practices suggest a smarter workload for future federal contracting.

by Vernon Myers, Col., USA (Ret.)

Procurement organizations across the federal government face the same challenges, specifically, the requirement to maintain adequate resources to execute the mission of contracting for goods and services in support of execution organizations.

Additionally, budget constraints, inexperienced personnel and unstable requirements further strain the system.

Meanwhile, requiring activities are obligating money faster and resource managers are pulling funds more frequently to meet critical requirements. The ACC Fact Sheet stated in 2017 that the U.S. Army Contracting Command (ACC) and its 6,000 civilian and military personnel executed over 165,000 actions valued at more than \$62 billion. Assuming that these trends continue, what new technology do we have available right now or in the near future that

could fundamentally transform or disrupt the federal procurement domain? What new innovative business models will shape the way procurement professionals serve customers in the future?

Intelligent contracting is an aspirational, high-level vision of what federal procurement could be in 10 to 20 years. It represents the convergence of three primary and three supporting emerging technologies that may be able to facilitate the entire procurement value chain, from requirements development and solicitation to contract award and performance. The primary technologies are cloud computing, artificial intelligence (AI) and big data, while the supporting technologies are intelligent-agent technology, smart contracts and blockchain. (See Figure 1, Page 148.) I intend to paint a picture of a new vision for the future of federal procurement based upon the integration of the six emerging technologies that will deliver the innovative intelligent contracting platform.

FIGURE 1

PRIMARY TECHNOLOGIES

CLOUD COMPUTING

Cloud computing is the practice of using a network of remote servers to store, manage and process data over the internet, rather than a local server or a personal computer.

ARTIFICIAL INTELLIGENCE

AI is the analysis, evaluation and decision-making function within the intelligent contracting concept. It is an area of computer science that emphasizes the creation of intelligent machines that work and react like humans. Computers with artificial intelligence may be used for speech recognition, learning, planning and problem-solving, among other activities. AI works by combining large amounts of data with fast, iterative processing and intelligent algorithms, allowing the software to learn automatically from patterns or features in the data.

BIG DATA

Big data consists of extremely large datasets that may be analyzed computationally to reveal patterns, trends and associations, especially relating to human behavior and interactions. The data that would be needed to support the intelligent contracting concept already exists in databases throughout the federal government. Examples of existing data centers and repositories include the Federal Procurement Data System Next Generation, the Virtual Contracting Enterprise and the Procurement Integrated Enterprise Environment.

SUPPORTING TECHNOLOGIES

INTELLIGENT AGENTS

Intelligent agents are the execution function within the intelligent contracting concept. An agent is defined as one who acts for or in the place of another. Virtual agents have been known by many other names, including bots, personal assistants, software agents and knowbots. Intelligent agents possess the ability to act on their own to sense, perceive and communicate with human users, other agents or objects. Intelligent agents can plan, set goals, reason effectively and improve their knowledge and performance through learning.

SMART CONTRACTS

Smart contracts are a computer protocol intended to digitally facilitate, verify or enforce the negotiation or performance of a contract. A smart contract is a computerized transaction protocol that executes the terms of a contract and allows the performance of credible transactions without third parties. A blockchain-based smart contract is visible to all users of the blockchain.

BLOCKCHAIN

A blockchain is a decentralized, distributed and often public digital ledger that is used to record transactions across many computers so that any involved record cannot be altered retroactively, without the alteration of all subsequent blocks.



Illustration Getty Images

The current workforce will need to be retrained to integrate and work with emerging technologies.

Innovation is a future vision delivered. As outlined above, the six emerging technologies exist right now, and four of the six are already being used in diverse federal government applications. I'm advocating that we think bigger by harnessing the capacity and creativity of industry and government to move the procurement business model forward into the 21st century. We are on the verge of intelligent contracting, but we must all work together to bring this vision to life.

VISION

I became interested in intelligent-agent technology a few years ago when I entered a contest and developed an idea called the Federal Multi-Agent System. It is a platform that connects all federal executive agencies in a system whereby intelligent agents (an army of Siris or Google Assistants) would execute the millions of daily services required by citizens from the government every day, such as applying for a passport, renewing a driver's license or paying taxes. Citizens would have the ability to deploy personalized intelligent agents anytime, anywhere and for any legitimate service provided by the government.

I believe that intelligent agents can increase speed and accuracy and decrease the cost of executing contract actions across the federal government, under the direction of AI, operating within a government cloud architecture, using data from millions of historical contract actions, leveraging smart contract technology as the contract instrument and using blockchain to secure the transaction. Let's look at how these

emerging technologies are currently being used and then apply them to the federal procurement space.

PROCUREMENT NOW: WE CAN DO BETTER

Federal procurement is a defined market whereby customers (requiring activities) engage market facilitators (contracting agencies) to initiate agreements with suppliers (government contractors) via a transparent and secure marketplace (beta.sam.gov, which includes the former Federal Business Opportunities) for goods and services to be delivered at specific dates in the future. The current federal procurement business model has served us well over many decades and will continue to do so into the foreseeable future. However, by leveraging these six emerging technologies (see Figure 1), the method of contract delivery and execution can be made more transparent, more efficient and more cost-effective. What new technology do we have available right now or in the near future that could disrupt the current contracting business model? Since the government is often slow to adopt new technologies, we are most likely a few years away from seeing the convergence of these technologies in the procurement domain; however, it is worth the effort to look at what might be possible.

The next section will cover the vision for the future of procurement that includes the development, integration and deployment of the intelligent contracting platform across the federal government. The end state of this vision will be a relevant, cost-effective and technology-enabled

procurement ecosystem that puts the best emerging technologies into the hands of a trained and ready workforce, thus creating value for stakeholders throughout the federal government.

PROCUREMENT FUTURE: IMAGINE THE POSSIBILITIES

The three primary technologies—cloud computing, AI and big data—must be developed and integrated to provide a robust infrastructure for the intelligent-contracting platform. The government would need to establish a dedicated cloud architecture that could support AI, big data, intelligent agents, smart contracts and blockchain capabilities. The intelligent contracting platform would operate within a cloud computing infrastructure similar to the cloud services provided by Amazon Web Services to the world's largest commercial enterprises. By initiating a contract with a leading cloud provider to host the cloud computing infrastructure, the government also would have the ability to quickly scale the intelligent contracting concept at a reasonable cost. AI, combined with data from existing government data centers and intelligent agents, will provide an advanced way to automate the procurement process by finding data, analyzing the data, making recommendations and providing predictive analysis to assist humans in making procurement decisions that are in the best interest of the government. For example (see Figure 2, Page 151), after a contracting professional receives a requirements package, the AI will assist by analyzing data from historical contract actions, solicit the requirement through the government marketplace, assist with

Contract delivery and execution can be made more transparent, more efficient and more cost-effective.

the receipt and evaluation of proposals and, finally, enable the award of a smart contract. While most of the data needed to launch the intelligent contracting concept already exist in databases across the federal government, the data will need to be sent through a methodical process to clean, organize and package it to allow intelligent agents, smart contracts and blockchain to efficiently use it to execute the intelligent-contracting system functions. By using data the government is already collecting, the intelligent contracting system will be able to feed data to the AI to enable it to, in conjunction with humans, analyze how best to execute each procurement's acquisition strategy.

The three supporting technologies of intelligent agents, smart contracts and blockchain must be developed and integrated to provide the dynamic operational capability required to facilitate the procurement process. Intelligent agents will work in conjunction with humans, AI and big data to navigate a contract action through the entire process. By using intelligent agents to facilitate procurement, productivity will be increased across organizations, and this self-service capability will be provided to customers in an always-on and available mode. A smart contract is an output of the intelligent contracting concept that provides a secure contractual instrument that can be used for contract award, performance verification and payment for services rendered. Blockchain is a relatively new technology that has been most associated with Bitcoin and cryptocurrency; however, it has many more potential applications. It is the mechanism that would be used to facilitate contract award, payment and verification of performance or delivery of goods and services. One use case for blockchain is as a tool for awarding and recording transactions, including contract actions. By using blockchain technology, contracting professionals can automate the process of contract award and administration by setting parameters for contract award, payment and performance verification.

The combination of these six emerging technologies and a trained, capable and empowered workforce will ensure that the intelligent contracting system can meet the requirements of the most demanding and dynamic stakeholders in the future. Innovation is the future delivered. How will the government move from

the current state to the future vision of the intelligent contracting platform?

BRIDGING STRATEGIES: HOW DO WE GET THERE FROM HERE?

Intelligent contracting is an exciting vision of the future of procurement that uses six emerging technologies—cloud computing, artificial intelligence, big data, intelligent agents, smart contracts and blockchain. This section will cover potential bridging strategies to transition from where we are right now to a future state enabled by the intelligent contracting ecosystem. Although the six emerging technologies are currently used in diverse commercial and governmental applications, implementation concerns and other risks still exist. The process of identifying emerging technologies and developing a big idea is the easy part. The more significant challenge is to figure out how the government will integrate the emerging technologies into a platform that can be fielded and sustained throughout the life cycle of the system. The remainder of this section will discuss key leadership considerations related to cybersecurity risks, new legislation, funding and prioritization and the AI workforce.

If government leaders decided to implement this intelligent-contracting concept, they would need to conduct a thorough risk analysis. One risk that stands out is cybersecurity vulnerability. Identifying and reducing cybersecurity risks would be critical to integrating the six technologies into a system that complies with government cybersecurity requirements and delivers value to stakeholders. After identifying, assessing and mitigating key risks, leaders must gain an understanding of AI-focused legislation that provides authority to fund the AI-enabled intelligent contracting ecosystem.

Government leaders must become knowledgeable and adept at leveraging key AI-focused legislation. In 2017, the Trump administration identified AI as one of its top research and development priorities by emphasizing the requirement for AI project proposals to include an “all-of-government” benefit to gain approval. In 2018, the Modernizing Government Technology Act was signed into law to provide authority to fund IT projects across the federal

FIGURE 2

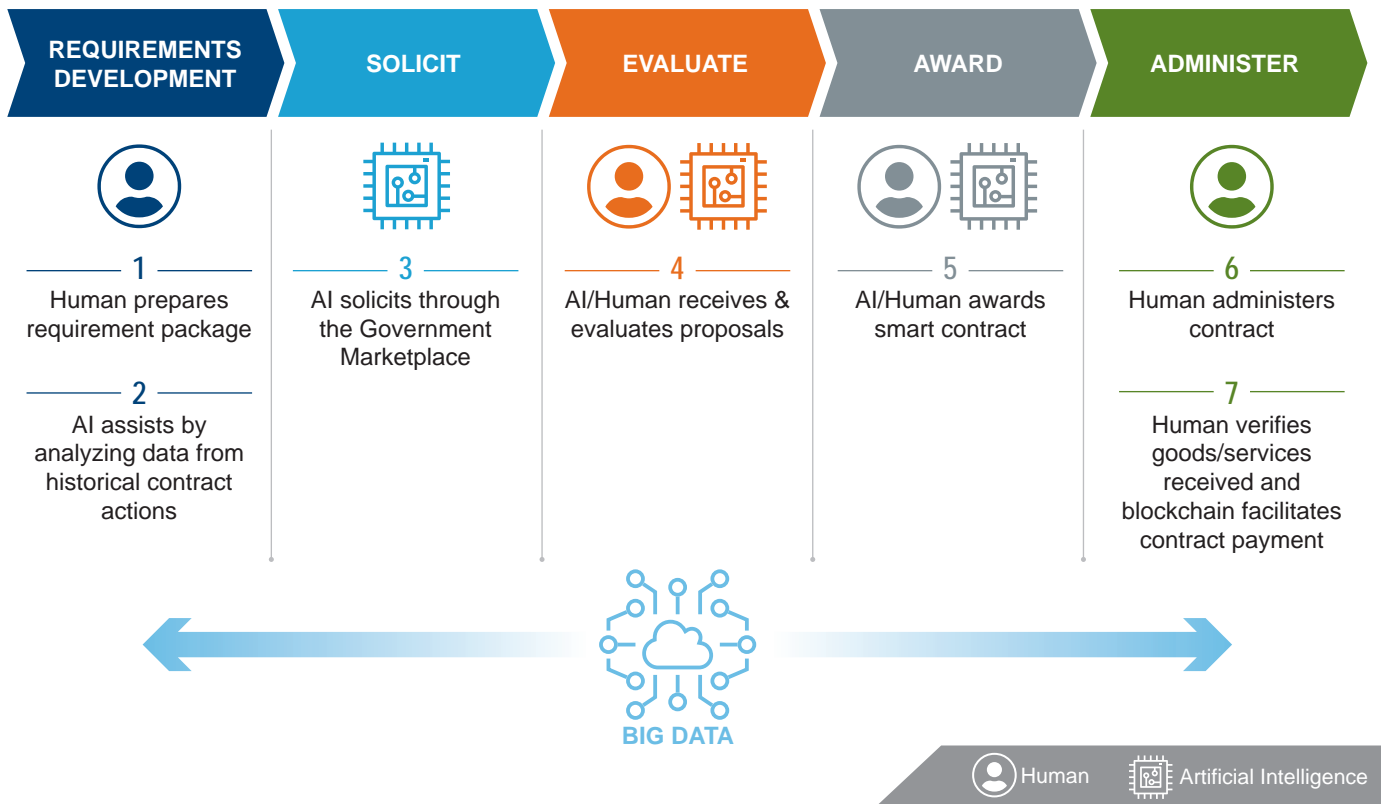

FUTURE OF PROCUREMENT

Combining AI with data from existing government data centers and intelligent agents will provide an advanced way to automate the procurement process. (Source: The author)

government valued at up to \$250 million. In 2019, the American AI Initiative was created, and the Artificial Intelligence in Government Act was enacted into law.

The American AI Initiative is the United States’ national strategy on artificial intelligence, which focuses the resources of the federal government on AI by emphasizing five key areas:

- Investing in AI research and development (R&D).
- Providing AI R&D experts access to federal data, models and computing resources.
- Building trust by establishing policies for AI development.

- Prioritizing training to help American workers gain AI-relevant skills.
- Protecting America’s AI advantage by engaging internationally.

The Artificial Intelligence in Government Act seeks to prioritize cohesion and competency in the federal government’s use of AI by increasing expertise concerning emerging technologies and developing and advancing public sector AI. The law accomplished these broad AI policy directives by requiring the General Services Administration to create an AI Center of Excellence to oversee the rollout of AI technology throughout the federal government. By gaining an understanding of new policy and legislative guidance, leaders will

be able to establish a framework to support future funding and prioritization decisions related to AI and the intelligent contracting platform.

Government leaders must clearly understand the funding and prioritization that drive investment in new technology. For example, in the research study “Opening Government’s Digital Playbook,” the Centre for Public Impact, a London-based think tank, reported that of the \$90 billion spent by the federal government on technology, 75 percent was spent on maintaining legacy systems. The Army Modernization Strategy 2019 assumed that the Army budget would most likely remain flat, thus reducing its



A NEW LOOK

Ruben Cruz, procurement analyst for the Army Artificial Intelligence Task Force, examines sensors in an autonomous robot built at Carnegie Mellon University in the 1980s. Intelligent contracting would affect government acquisition from requirements development and solicitation to contract award and performance. (Photo by Gary Sheftick, Army News Service)

The three supporting technologies of intelligent agents, smart contracts and blockchain must be developed and integrated to provide the dynamic operational capability required to facilitate the procurement process.

spending power over time. Although the Army did not project future growth in its budget, it still designated AI as an Army research priority because it would help the service increase the speed and agility with which it responds to current and future threats. While funding and prioritization are important factors, leaders must also consider the engine that powers the new intelligent contracting platform—the workforce.

Government leaders must understand that the intelligent-contracting system will only be as good as the workforce that operates, maintains and sustains it. Change driven by innovation and new technology may create a fear among staff that they will be replaced by computers or by people with more relevant skill sets. How will the implementation of the intelligent contracting platform impact the contracting workforce? What will happen to the thousands of federal workers who have spent years learning a craft that will eventually be facilitated by AI and intelligent agents?

The early answer is that the current workforce will need to be retrained to integrate and work with emerging technologies; however, it's important to note that these

technologies will not replace the contracting workforce. Early research has shown that AI works best in conjunction with humans, and as Michael Luca, Jon Kleinberg and Sendhil Mullainathan noted in the Harvard Business Review in its January–February 2016 issue, even algorithms need to be managed. The bottom line is that there will be a requirement to retrain workers to work in collaboration with AI and other emerging technologies; however, technology will not replace people.

CONCLUSION

Implementation of this intelligent-contracting platform will require the right people with the right expertise, including a workforce that is skilled in the design, development and use of AI in diverse applications. In preparation for this future requirement, the AIGA required the Office of Personnel Management to identify the skills federal workers would need to work with AI and to develop an AI-specific job series based on those skills. Laura Cox, senior staff writer at disruptionhub.com, identified change as the only constant in business, and that the disruptive nature of digital technology will increase the speed of change and impact how organizations operate. Federal contracting agencies will not be excluded. The government should

get ahead of the coming changes by harnessing the power of the six emerging technologies and identifying procurement transformation as a top priority for government agencies.

For more information, contact the author at vernon.l.myers2.civ@mail.mil.

VERNON MYERS, Col., USA (Ret.), is the acting deputy executive director at U.S. Army Contracting Command – Orlando, Florida. He is currently pursuing a Doctor of Business Administration with a specialization in innovation and strategy at Capella University. He holds an M.S. in materiel acquisition management from Florida Institute of Technology and a B.S. in business administration from Central State University. He is an avid student and practitioner in the areas of leadership, innovation and creativity and is the author of “The Idea Journal: A Tool for Unleashing Your Urge to Create.” He is an Army Acquisition Corps member, is Level III certified in contracting and in program management, and has earned the Project Management Professional (PMP) certification. His last article in Army AL&T, “What the Customer Sees,” appeared in the April-June 2012 issue, Page 93.

INDUSTRY INSIGHT

COMMUNICATION SKILLS

Industry helps to keep tactical communications interoperable as the Army modernizes.

by Charlie Kawasaki

Communications interoperability remains a persistent challenge for DOD organizations relying on a multitude of communications equipment, including handheld radios, desktop phones, laptops and intercom systems. In a familiar rinse-and-repeat process, tactical organizations looking to improve communications capabilities acquire cutting-edge solutions to address specific battlefield use cases, deploy it to only a subset of warfighters and struggle to achieve fully interoperable communications across all echelons and partners.

It is a circuitous problem with which the U.S. Army is all too familiar. As organizations field more types of equipment for specific requirements, this translates to an inability for warfighters to reliably and securely communicate with each other, thereby impacting situational awareness and, most importantly, mission success.

U.S. Army Futures Command leadership recently noted that enhancing interoperability of tactical radio and battlefield communications is key to enabling optimal function in future missions. As a result, the Army is currently working with industry partners to advance innovations that address these warfighter challenges. Additionally, numerous major Army tech initiatives are continuing to expand reliance on tactical

communications to achieve and maintain warfighting advantages. These initiatives include increasing command post mobility, delivering advanced situational awareness and communications to the dismounted warfighter, and enabling remotely operated and autonomous systems. Without advanced and interoperable communications, these technologies will have limited effectiveness.

While the Army is planning rapid implementation of these advanced technologies that increase reliance on communications networks, it also acknowledges growing threats to communications in the form of cyber and electromagnetic warfare. To protect against these threats, as well as to mitigate other issues that can disrupt communications (such as equipment failure, radio-blocking terrain, weather, etc.), the Army is putting renewed emphasis on enabling the military's traditional communication planning framework: primary, alternate, contingency, emergency—more commonly known as PACE.

In any given mission, there must be multiple ways to communicate in case there is a communications failure. Planning is underway to enable networks with multiple radio types that each provide different capabilities—including experimentation with LTE and 5G,



Interoperability must extend beyond simple communications between like organizations, staff and vehicles—it must also be secure, lightweight, rugged, simple to operate and reliable.

new forms of satellite communication (SATCOM), free-space optics and meshing radio. However, in order to enable these backup measures, all solutions must first be interoperable.

A COMPLEX PUZZLE

Establishing and maintaining tactical communications on the battlefield to ensure interoperability for Army battalions, brigades, divisions, companies and platoons is an incredibly complex endeavor. Addressing needs of joint operations, operations with coalition partners

and host nations—and even civilian first responders for humanitarian assistance and disaster response activities—further complicates the equation. Doing so while meeting reliability, security and emerging requirements demands addressing multiple, interconnected challenges.

Among the high-level challenges of this communications puzzle are:

- Most tactical communications solutions in the field are still primarily based on handheld radios. Among them is a wide array of vastly different legacy and modern radios. These different radios have varying levels of analog and digital capabilities.
- Innovation in radios, including advances in software-defined radios, results in a fast-growing number of disparate, incompatible waveforms—but programs cannot afford to upgrade all radio users simultaneously every time a new innovation is available.
- Inherent limitations in range for radios necessitate networks that include multiple radio types such as line-of-sight, meshing, beyond-line-of-site and SATCOM.

LIVE COMMUNICATIONS

The Army needs advanced interoperable communications so that Soldiers can communicate in real time, helping to ensure mission success. (Photo courtesy of PacStar)

- Upper echelons and Soldier-worn devices tend to utilize commercial off-the-shelf (COTS) Internet Protocol (IP)-based solutions that rely on Session Initiation Protocol and Unified Communications (UC)—rather than push-to-talk waveforms.
- Joint, partner and civilian communications require different levels of classification, necessitating careful security design and separation of communications networks—often resulting in the need to field multiple radio types.
- Commonly fielded radios may support communications on only a single channel—necessitating organizations to field multiple radio base stations in order to provide interoperability to multiple teams of communicators.
- No single vendor makes more than a few components of the complete communications solution—requiring extensive integration. This further drives up training requirements, as systems become ever more complex.

This list makes it plain that the current initiatives to achieve resilient communications will drive up the number of

Enhancing interoperability of tactical radio and battlefield communications is key to enabling optimal function in future missions.

radio types; add to the size, weight and power of the combined solutions; and increase the complexity of said solutions. These challenges also illustrate why there is a critical need for communications interoperability that encompasses multiple radio types and IP communications, in tactical-ready form factors that are integrated, reliable and easy to use.

SOLVING THE PUZZLE

DOD is actively innovating and working with industry partners to develop and field solutions that integrate disparate radios, waveforms, IP networks, cybersecurity technologies and UC systems. A key approach utilized to align these communications capabilities is Radio-over-IP (ROIP), which converts analog signals like standard radio transmissions into a digital, IP format that is compatible with nearly all modern communications technologies. Through this digitization, the Army can incorporate multiple radio signals into existing (and future) tactical networks, enabling remote access over vast distances to networks, and enhancing interoperability for the non-radio devices it uses, such as tablets and laptops, that the Army has deployed across its various echelons.

Historically, ROIP systems have large, discrete equipment that is not built for mobility and rugged tactical environments, and is not integrated into a full IP suite. Hauling around this type of legacy equipment limits the ability of warfighters to stay agile. Therefore, optimizing these solutions for size, weight and power; environmental protection; integration with IP suites; and total system usability can deliver seamless communication and maximize mission success.

Fortunately, the U.S. Army is working across multiple programs to coordinate efforts toward addressing the needs and technical challenges outlined above. By making requirements clear to the defense industrial base, the Army enables rapid innovation made available in COTS solutions that can deliver the needed capabilities. These key advancements now making their way into the hands of warfighters can enable:

- **Enhanced radio interoperability.** Organizations have fielded systems providing radio interoperability and ROIP in the past—many of which were large, not rugged and poorly integrated. The Army can now leverage solutions that integrate multiple, disparate communications networks (radio, Voice over Internet Protocol, ROIP, SATCOM, etc.) that solve these communications challenges in the smallest available size, adapting popular radio types, phones and intercom systems into a common communications format—Internet Protocol.
- **Incremental deployment.** Interoperability between new and legacy radio technologies allows organizations to periodically deploy new solutions without requiring all communications users to upgrade at the same time or to the same equipment.
- **Unified communications integration.** Bringing all these pieces together can connect the warfighter on the front lines to the upper Army echelons, including enterprise IP networks. This in turn delivers “voice convergence,” ROIP and UC that integrate multiple communications networks through simple connectivity.
- **NETOPS integration.** New ROIP and radio systems are increasingly integrated into software-based NETOPS systems, improving manageability, reducing training time and expense, and offering new options for automated PACE. NETOPS encompasses technologies and processes related to network management and configuration, network cybersecurity assurance and network situational awareness.
- **Flexible and scalable deployment.** Modular systems are key to optimizing solutions for specific program requirements, as there is a need to scale from small, Soldier-carried solutions to multi-radio network deployments across forward operating bases, command posts, ground vehicles and aircraft.

Soldiers depend on the ability to seamlessly communicate in real time and be aware of their surroundings. Interoperability must extend beyond simple communications between like organizations, staff and vehicles—it must also be secure, lightweight, rugged, simple to operate and reliable. Thanks to current advancements in technology and a coordinated, cross-functional



RELIABILITY IS KEY

Soldiers depend on the ability to seamlessly communicate—interoperability must extend beyond simple communications. It also must be secure, lightweight, rugged, simple to operate and reliable. (Photo by Sgt. Dustin Biven, 75th Field Artillery Brigade)

focus on network interoperability, the Army is poised to unlock unprecedented command, control, computers, communications, cyber, intelligence, surveillance and reconnaissance capabilities for warfighters in hostile territory, giving the U.S. Army and its partners the best equipment to ensure mission success.

For more information about new IT technologies transforming the battlefield, go to www.pacstar.com.

CHARLIE KAWASAKI, Certified Information Systems Security Professional, joined PacStar in early 2005. He is the chief technical officer, leading numerous innovation programs and developing tactical solutions for secure wireless, cybersecurity and data center applications. He is part of the PacStar team that recently won the networking equipment awards for both the U.S. Army Transportable Tactical Command Communications and U.S. Marine Corps Networking-On-The-Move vehicle-mount and deployable tactical communications programs. He has more than 35 years' experience

With radio-over-IP digitization, the Army can incorporate multiple radio signals into existing (and future) tactical networks.

in cybersecurity, software and network engineering, and systems integration. He serves on the board of the Technology Association of Oregon, is vice chair of the Oregon Cybersecurity Advisory Council (www.cyberoregon.com), and is co-founder of Northwest Cyber Camp (www.nwcyber.camp). Read Kawasaki's last article in Army AL&T magazine's Spring 2019 issue at <https://asc.army.mil/web/news-alt-jfm19-four-future-trends-in-tactical-network-modernization/>.

TRAINING MARCHES ON



Developing leaders for the future Army Acquisition Workforce doesn't stop, not even in the face of a pandemic.

Remember when we thought the COVID-19 pandemic would be in our rearview mirrors by July? Needless to say, that hasn't happened. But like the rest of the Army, and indeed the entire DOD, your Army Director of Acquisition Career Management (DACM) Office remains hard at work.

An important job of the DACM office—managing leadership training for the Army Acquisition Workforce (AAW)—continues. But there are changes coming; some partly in response to the pandemic, others designed to improve the programs to align training and leader development to an evolving AAW.

Let's take a look at some of those programs.

LEADERSHIP EXCELLENCE ACQUISITION DEVELOPMENT

Even before the pandemic, we had decided to shut down the Competitive Development Group/Army Acquisition

Fellowship (CDG/AAF) for fiscal year 2020 to evaluate the program. We wanted to ensure that CDG/AAF, which began in 1997, was in line with the evolving requirements of the acquisition community. We decided to refocus the program to better meet a glaring need: No program existed to help prepare civilians at the NH-III level—GS-12 to GS-13, or other broadband equivalent—for our program manager (PM) roles. The resulting program—Leadership Excellence Acquisition Development (LEAD)—grew partly out of feedback from previous cohorts, and partly from the desire for more PM-centric training to provide more qualified civilian PM candidates.

The new program will be shortened from 36 months to 24. The shorter time frame means all required Civilian Education System distance-learning classes must be completed before a candidate can be accepted. Candidates also must be Defense Acquisition Workforce Improvement Act (DAWIA)-certified to the highest level

We want our officers to receive instruction from academic professionals who are pioneers in the field.

in their current acquisition career field, as well as being certified in program management. The first LEAD cohort will likely have some necessary grandfathered acceptance clauses.

The changes don't end there. Previously, students negotiated their assignments. LEAD will add additional structure to the assignment negotiation process. For example, in an effort to put theory into practice, each student will rotate through the Pentagon as a DA system coordinator (DASC) within the Deputy for Acquisition and Systems Management in the Office of the Assistant Secretary of the Army for Acquisition, Logistics and Technology. These assignments will be as NH-III 0340s, versus the previous 0301 training assignment series.

The new program includes a writing assignment: Students will be required to submit an article for publication in Army AL&T magazine or on the Army AL&T News website. We have also engaged previous CDG/AAF graduates for mentoring relationships with the new students.

The application process also will be enhanced. In addition to utilizing CAPPMS—the Army's source for acquisition career management—for the application portal, candidates will be further vetted by the Army DACM's Talent Management Board of Directors, a Senior Executive Service- or flag officer-level board.

The official announcement for applications to the inaugural LEAD class will come in October.

INSPIRING AND DEVELOPING EXCELLENCE IN ACQUISITION LEADERS

Another key program we've further developed is Inspiring and Developing Excellence in Acquisition Leaders (IDEAL). The

program is designed to develop current and future AAW supervisors. The program consists of multiple one-week sessions over a period of approximately six months. Applicants must be GS-12, -13, -14 or broadband equivalent, and DAWIA certified in their current position.

Because of the pandemic, we're going to conclude the fiscal year 2020 cohort using Microsoft Teams. We're canceling the fiscal year 2021 class. We hate to do that, but IDEAL optimally requires resident, face-to-face training. For the 2020 class, we're transitioning to small groups of four to five with an instructor. The typical off-site visit won't happen.

When we resume the IDEAL program, we'll move forward having learned some valuable lessons. IDEAL leans more toward developing existing supervisors, which is why we plan to open it up to GS-14s or broadband equivalents.

TRAINING WITH INDUSTRY

We've also expanded our Training With Industry (TWI) program. TWI is a one-year work-experience training program that embeds selected acquisition officers into corporate America, exposing them to the latest commercial business practices, organizational structures and cultures, technology development processes and corporate management techniques.

TWI grew from 10-12 positions in fiscal years 2016-2019, to 30 positions in 2020. The final number we'll have in fiscal year 2021 is yet to be determined, but the Army plans to maintain the growth of the program by tailoring TWI assignments more specifically to get officers the right experience to prepare them for future commands. Thus an officer involved in vehicle acquisition likely would go to an automotive company; a logistics-heavy program officer to a company like Amazon or FedEx; an officer involved in electronics would probably go to an electronics company. Each TWI position would be tailored with placing the right officer in the right company to better serve the Army down the line. Then, at the conclusion of the TWI assignment, we would expect to utilize that officer in follow-on activities that were enhanced by the experience.

ADVANCED CIVIL SCHOOLING PH.D. PROGRAM

The Army Acquisition Corps is providing a path for select officers to earn a doctoral degree and become acquisition technical experts through Advanced Civil Schooling. Such experts support the Army's scientific and engineering needs across a broad spectrum of assignments, including product and project managers, to



ALL OVER THE MAP

The Army’s Training With Industry cooperative program has been conducted at locations all across the country. (Graphic by U.S. Army Acquisition Support Center)

achieve real-time technology solutions to immediate and future battlefield challenges. Examples of needed technical degree paths are:

- Cyber and networks.
- Computer science and engineering.
- Robotics.
- Physics.
- Aerospace engineering.
- Artificial intelligence and machine learning.
- Autonomous systems.
- Directed energy.
- Materials engineering.
- Aeronautical engineering.
- Mechanical engineering.
- Biotechnology.

Each officer’s path will be unique, offering opportunities to work in research and directly impacting modernization priorities through product management responsibilities. We currently

have five officers pursuing a Ph.D. in material science, human-centered computing, aeronautical engineering, and information systems and data analytics.

GWU LAW SCHOOL

We have developed a partnership with George Washington University (GWU) Law School for a pilot program in the Master of Studies in Law with a concentration in government procurement. This is an addition to the existing Advanced Civil Schooling program for officers. It provides an advanced education opportunity from a quality program that is intended for professionals who are not interested in earning a law degree or practicing law, but require knowledge of the law for their jobs. GWU Law School considers itself to be the birthplace of the government procurement law discipline, and we want our officers to receive instruction from academic professionals who are pioneers in the field. Our intent is that acquisition officers will benefit from using their experience to build on critical thinking and gain a deeper understanding of policy and law.

EMERGING ENTERPRISE LEADER

The Emerging Enterprise Leader program is a one-year developmental program that provides aspiring leaders in the grades GS-11 and GS-12 (or equivalent) within the program executive offices and the U.S. Army Acquisition Support Center with specialized junior-leader development. Because of the COVID-19 pandemic, it will be on hiatus for fiscal year 2021.

CONCLUSION

Are there other opportunities you’ve observed during this pandemic that can better serve the acquisition community? We intend to continue refining the efficacy of these programs to ensure that their intrinsic value is maintained in improving our leadership and technical acumen. If you have any ideas that you would like to share, please don’t hesitate to contact me or my staff. Sharing ideas is the best practice in striving to be the most capable workforce for the Army.



The Army plans to maintain the growth of the program by tailoring TWI assignments more specifically to get officers the right experience to prepare them for future commands.

DACM OFFICE

The DACM Office is your one-stop shop for everything acquisition career-related.

The Director, Acquisition Career Management (DACM) is the Army’s senior-level advocate for all Army Acquisition Workforce (AAW) matters within the Department of Defense. The DACM has the authority to manage the integrated execution, oversight and resourcing of AAW education, training and talent management in line with the Defense Acquisition Workforce Improvement Act. To support this mission, the DACM office is organized into four divisions.





STAFF SGT. DEBRA STOKES

COMMAND/ORGANIZATION: U.S. Army Special Operations Command

TITLE: Contract specialist

YEARS OF SERVICE IN WORKFORCE: 3

MILITARY OR CIVILIAN: Military

YEARS OF MILITARY SERVICE: 12

DAWIA CERTIFICATIONS: Level II in contracting

EDUCATION: MBA, American Military University; B.A. in military management and program acquisition, American Military University

AWARDS: Army Commendation Medal (8th award), Army Achievement Medal (5th award), Army Good Conduct Medal (4th award), National Defense Service Medal, Iraq Campaign Medal, Global War on Terror Service Medal, NCO Professional Development Ribbon (2nd award), Army Service Ribbon, Overseas Service Ribbon (4th award), Armed Forces Reserve Component Medal (M Device)

SHOW UP AND TRY

“I was like 18 and I wanted to be tough.” Without context, those words strike fear in the hearts of parents everywhere. But for Staff Sgt. Debra Stokes, that moment was the start of a fascinating, unexpected and impressive Army career. Recently selected to conduct contracting with special operations units, she is the 2020 Army Contracting Command Best Warrior of the Year and the Army Materiel Command Noncommissioned Officer of the Year—and she’s not done yet. For the Air Force brat from Beavercreek, Ohio, enlisting in the Army was the first step. “My parents were Air Force, my dad retired from Wright-Patterson Air Force Base, and we lived nearby from third grade on,” she said. It wasn’t just about being tough, though. She saw more opportunities for herself in the Army, and had her grandfather’s example to follow.

And so far, her path has been anything but predictable. Stokes began her Army enlistment as a chaplain’s assistant. “That role is very different than what I do now in contracting,” she said, “but I gained a lot of people skills and learned to listen.” The experience helped to shape her character and equip her to handle difficult situations, she said.

She applied to the Army Acquisition Workforce after finishing graduate school. “I was eager to use my education and found this MOS [military occupational specialty],” she said. “It fit well with my fields of study.” In her first acquisition job, she worked as a contract specialist for the U.S. Army Mission and Installation Contracting Command (MICC) at Fort Riley, Kansas. “The challenge and the variety of contracting appealed to me,” she said. “The civilian workforce at the MICC became like family and taught me the ins and outs of basic contracting.”

Just a year later, she deployed to Jordan. “I was able to obtain a warrant so I could serve my team as a contracting officer.” The deployment was an important milestone in her career, because she gained experience with contracting in a contingency environment and learned to perform civilian employee reviews and appraisals. “And I went to air assault school.” A former chaplain’s assistant turned contract specialist, jumping out of helicopters in the desert? Sure. Why not?

“It was pretty cool,” she said. “My brigade was allowed to send one person to the school, and I was selected.” She was nervous to represent her team and wanted to perform well, which was quite a difficult task. “It was one of the most intense things you can imagine,” she said. Of 270 Soldiers who started the course, only 190 finished; 182 of them were men. “There were only eight females in the entire course and all eight of us made it,” she said. “Just that fact that half of us were moms and we held our own—it was such a rare opportunity.” She’s proud, and rightfully so.

So, what would come next for Stokes? More competition. “I most recently competed in the Army Contracting Command and Army Materiel Command Best Warrior competitions,” she said. And she won. “It was a *lot* of studying and training.” Naturally, things were a bit different this year during the coronavirus pandemic. “We



FASHIONABLE IN ORANGE

Stokes performs an on-site visit with a contractor at Fort Riley. (Photo by 923rd Contracting Battalion/MICC)

ended up doing a virtual board,” she said “and submitting our physical fitness test scores” rather than competing in person. Again, her unit came to her aid. “The MICC supported me and helped me practice for the competition.” She made and studied hundreds of flashcards, and her teammates at MICC held mock interviews to help her practice her presence and confidence with public speaking. “Their support was instrumental to my success,” she said.

Stokes shared the most valuable lesson she has learned in her career so far. “Just have the courage to show up and try,” she said. “Most of the time, it will work out and, if it doesn’t, at least you know you gave it your best shot.” She advises junior acquisition personnel to always ask “Why?” when

completing contracting tasks. “When people first switch to contracting, we jump into a fast-paced environment with no experience,” she said. “It’s like drinking from a fire hose.” Rather than just copying what was done before, she encourages everyone to learn by asking questions. “You have to know *why* to really understand the process.”

Today, her biggest challenge at work is trying to find a way to get to yes when acquisition challenges arise. “It can be hard to meet customer expectations while still following contracting rules and the FAR [Federal Acquisition Regulation],” she said. “We try to solve problems instead of just saying, ‘We can’t do that.’ A better way is to figure out how you *can* do it.” She feels it is important to

help customers understand the acquisition process through proactive and clear communication, and she strives to create mutually beneficial solutions. Apt advice from the Soldier who says to just “show up and try.”

For her next challenge, Stokes is taking on the world of special operations. “My unit at Fort Riley encouraged me to apply for a contracting position with a special operations unit,” she said. She was accepted and is now in the middle of moving to her new duty assignment with the U.S. Army Special Operations Command. If this new challenge is anything like her last, Stokes is sure to succeed. At least she’ll show up and try.

—ELLEN SUMMEY

MAXIMIZING POTENTIAL

Senior Rater Potential Evaluations help identify future leaders.

by Jacqueline M. Hames

The Senior Rater Potential Evaluation (SRPE) period is fast approaching—time for acquisition civilians to think about their future and potential as up-and-coming acquisition leaders. Since 2015, the SRPE has been required annually for Army Acquisition Workforce professionals GS-12 through GS-15 and pay band equivalent. Evaluations cover Oct. 1 through Sept. 30, and senior raters must complete the SRPE by Dec. 31.

So, what is SRPE? It is a talent management and employee development tool that can help supervisors identify future leaders. The SRPE assists leaders of civilian acquisition professionals to assess their potential to perform in or assume positions of increased responsibility, Norm Hilton, chief of the Army Acquisition Workforce Engagement Branch, explained. The Engagement Branch is part of the Director, Acquisition Career Management Office.

THE HISTORY

SRPE was developed in response to the need for a qualified and professional Defense Acquisition Workforce. In particular, Section 1733(a) of the Defense Acquisition Workforce Improvement Act requires that the best-qualified individuals be selected for acquisition leadership positions. The SRPE provides documentation of the leadership potential of civilian employees and allows selection boards to more easily and equitably compare civilian and military candidates, ensuring that the best person is selected for a leadership position.

In the April 2018 issue of the DACM Newsletter, Hilton gave a breakdown of how to assemble a SRPE and why it's critical to central selection board screenings. A central selection board is a group of people that evaluates a candidate's eligibility

for a leadership position using his or her career’s entire body of work. SRPE “is the primary tool used to document and communicate a candidate’s potential and readiness to assume positions of increased responsibility. If done right, it will send a definitive message to the board that eliminates any guesswork,” Hilton wrote. In other words, SRPEs allow the board to see a candidate’s skills and knowledge so the board can make an informed selection for an open leadership position. Some of the key take-aways Hilton highlighted are:

- Always use clear, quantifiable descriptions.
- Use short senior rater narratives and focus on enumeration (a sentence that sets the tone of the evaluation), potential for assuming increased responsibility, promotion, schooling and future assignment. It is not how much the senior rater writes that is important but the content of what is written.
- Include a duty description, senior rater narrative and number of employees at the equivalent grade being rated.

THE PROCESS

The evaluation process involves three people: the employee, the rater and the senior rater. “Historically, a rater is the person that supervises the individual,” said Brian Cole, SRPE program manager. “The senior rater is the supervisor’s supervisor. However,

it can change depending on how the organizations are aligned.” For example, the program management office may direct the deputy program manager to be the senior rater for all the GS-14s, while the program executive officer is the senior rater for the GS-15s.

The rater or supervisor may initiate a request for a SRPE for any civilian acquisition professional under their direct supervision. Employees review and provide a signature once the evaluation is completed. “The senior rater completes the SRPEs of their subordinates at the request of the employee’s supervisor, or annually for employees mandated by policy,” Cole said. The rater and senior rater also provide a digital signature on the completed SRPE.

While the SRPE process is similar to a performance appraisal, it is distinctly different, Cole explained. “A performance evaluation ... depicts what individuals have accomplished or how they have contributed to [their] current position. A SRPE is designed to define your ability to receive increased responsibility—so, that means your potential leadership skills in your position,” he said. A performance evaluation catalogs accomplishments, while the SRPE helps determine what an individual is capable of doing if selected for leadership. During a performance appraisal, employees should not be discussing their potential, just as in an SRPE they should not be discussing their performance, Cole added.

FIVE KEY ELEMENTS

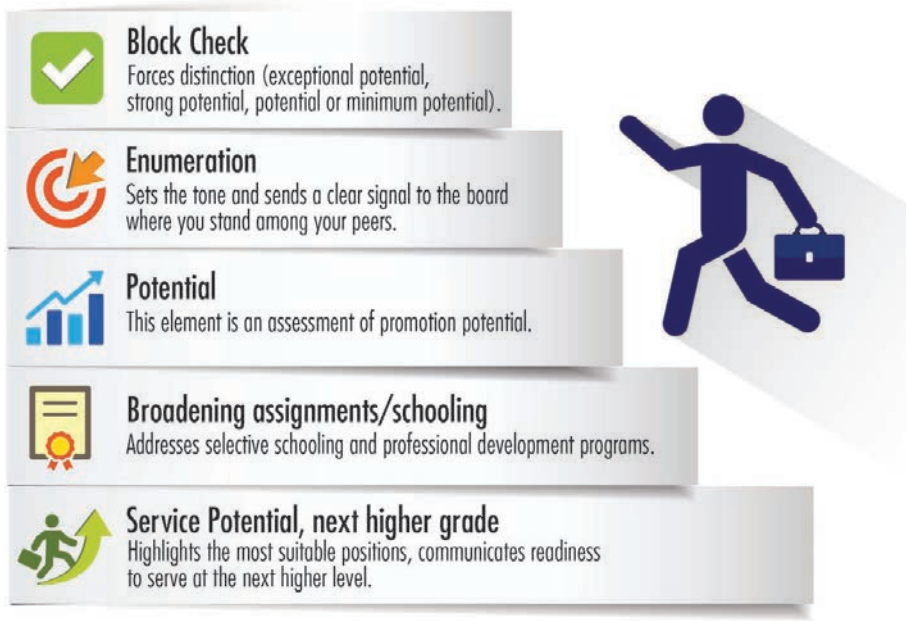

DISTINGUISH YOURSELF

By focusing on five key elements of the SRPE, Army acquisition professionals can maximize their potential for competitive advancement to high-level positions of leadership and responsibility. The SRPE is a tool to give selection boards the information they need on Army Acquisition Workforce civilians to clearly and equitably compare civilian and military candidates, ultimately ensuring that they choose the best person for the job. (Images by U.S. Army Acquisition Support Center)

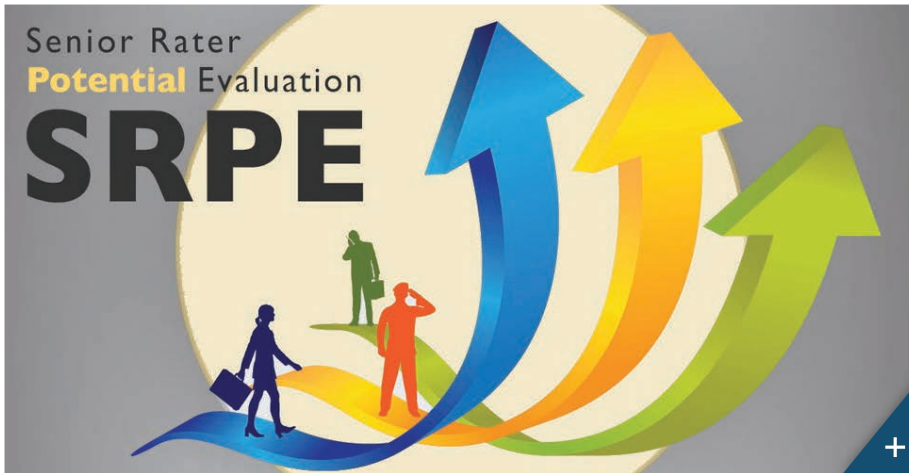

SRPE “is the primary tool used to document and communicate a candidate’s potential and readiness to assume positions of increased responsibility.”

ONWARD AND UPWARD

The SRPE is forward-looking, an assessment of the potential for civilian acquisition professionals to perform in positions of increased responsibility, based on their demonstrated leadership skills. In that respect, it differs from a performance appraisal, which looks back at what a person has accomplished or contributed in their current job.

The two processes share a common trait: open dialogue between the employee and the rater. Raters and employees have honest and frank discussions with their supervisors, Hilton said, often centered on their individual development plan, which serves as a base document in both the SRPE and performance appraisal. “There should be no surprises,” he said.

THE RESOURCES

There are many reference documents on the website that can be pulled if people have questions, Hilton said. Employees, raters and senior raters can find policies and guidance, videos, instructional briefings and a user manual on the website at: <https://asc.army.mil/web/senior-rater-potential-evaluation/>. Acquisition civilians who are experiencing the SRPE evaluation process for the first time should check out the live training tutorial within the SRPE module at: <https://apps.asc.army.mil/camp/>.

If you’re ever in need of an SRPE quick-reference, the SRPE Supervisor Reference Guide is perfect—go to:

<https://spcs3.kc.army.mil/asaalt/USAASC/USAASC%20Document%20Library/SRPE%20Supervisor%20Reference%20Guide.pdf#search=srpe%20reference%20guide>.

For a deep dive, or if you just haven’t found the right information yet, check out the FAQ section on the USAASC website. Filter for “SRPE” at: <https://asc.army.mil/web/all-faqs/>.

For more information, contact Brian Cole at brian.k.cole2.civ@mail.mil.

JACQUELINE M. HAMES is an editor with Army AL&T magazine. She holds a B.A. in creative writing from Christopher Newport University. She has more than 10 years of experience writing and editing news and feature articles for publication.

LESSONS LEARNED FROM A MIDDLEMAN

Liaison officer provides a snapshot of two unified Army network modernization offices.

by Tyler J. Cook

People always talk about cutting out the middleman, but in the case of Army network modernization, the middleman can serve an essential role.

As an employee of Project Manager Tactical Network (PM TN) at the Program Executive Office for Command, Control and Communications – Tactical (PEO C3T), I had the unique opportunity to serve in a developmental assignment as the PM’s liaison officer to the Network Cross-Functional Team—one of eight cross-functional teams assigned to the Army Futures Command. I was embedded within the network team for one year, serving as a middleman between the two offices. Although I often wore many hats, ultimately my main responsibility was to help the two organizations remain synchronized. In the current environment of limited resources, it is critical to synchronize messaging across stakeholders, thus providing senior leaders and Congress with clear insight into the team’s mission. Synchronization speeds the decision-making process and enables the team to focus its efforts holistically and deliver results more rapidly.

LEARNING BY DOING

Both PEO C3T and the Network Cross-Functional Team work to foster a team environment. With support from an engaged leadership, that environment includes professional development and talent management. I found myself immersed in this new developmental role, working side by side with high-ranking Army officers and civilians. I had the opportunity to brief colonels and general officers on a daily basis, and even had the honor to meet Secretary of the Army Ryan D. McCarthy.



MOVE OUT

The author participated in Capability Set 23 planning discussions, which involved tailoring the ITN to Stryker and armored units. He saw results of the Network Cross-Functional Team’s work, including this Stryker vehicle integrated with Tactical Network Transport – On the Move capability, in September 2019 at the National Training Center, Fort Irwin, California. (Photo by U.S. Army)

My duties included representing PM TN in the activities and initiatives of the Network Cross-Functional Team, communicating relevant information between organizations, coordinating PM support of the network team’s tasks and requests for information; and ensuring that the team’s modernization strategy, priorities and messaging accurately represented the PM’s challenges. This was especially important for things such as requirements, funding and the search for enabling technologies.

TWO TEAMS, ONE UNIFIED MISSION

As part of its 2018 Army Network Modernization Strategy, the Army stood up the Network Cross-Functional Team to augment traditional acquisition through rapid prototyping and experimentation. The organization identified four primary lines of effort to guide tactical network modernization:

- Unified network.
- Common operating environment.
- Joint interoperability and coalition accessibility.
- Command post mobility and survivability.

I directly supported the unified network line of effort, which aims to make the network stronger, more reliable, secure and mobile to ensure that tactical units can stay connected and communicate in hostile environments. Since most of PM TN’s portfolio supports this goal, the assignment was a perfect fit for my background and an extraordinary opportunity to expand my acquisition proficiency.

As the Army intended when it stood up the cross-functional teams, PM TN and the network team rely heavily on their partnership and intense collaboration to identify options for innovative solutions, make tough decisions and ultimately

drive network modernization outcomes. The team’s strongest attribute is its ability to use stakeholder relationships across the network requirements, acquisition, and science and technology communities to work through goals, options, solutions and courses of action (COAs).

My developmental assignment was a unique opportunity to learn how the Army makes decisions on key network modernization efforts and to witness firsthand the extensive behind-the-scenes actions that lead to those decisions. In some instances, I was involved in the formal military decision-making process—a proven analytical process that helps the commander and staff develop, integrate and synchronize their plan. It consists of seven steps:

- Receipt of mission.
- Mission analysis.
- COA development.
- COA analysis.

- COA comparison.
- COA approval.
- Production of orders.

Other efforts also followed a governance structure—a formal process that optimizes efforts across different working levels—to obtain leadership buy-in and concurrence.

At the lower working levels, we gathered and distributed all of the most recent facts, assumptions and other pertinent information to enable leadership to make solid, informed decisions. In some instances, leaders would decide to use one of the recommended COAs, while in others, they thought outside the box, combining different COAs or creating entirely new ones to overcome the particular challenge at hand.

TWO ORGS ARE BETTER THAN ONE

As part of the Army's network modernization strategy, PEO C3T and the Network Cross-Functional Team together are delivering phased network capability enhancements on a two-year basis, beginning with Capability Set 21 in fiscal year 2021. The goal is to deliver a modernized network to support a force capable of multidomain operations by 2028.

The Army will build on lessons learned from the development and fielding of each capability set, including work being done with new and evolving satellite capabilities. As part of the capability-set delivery, the team embraces the developmental operations process, leverages acquisition authorities, establishes program baselines and executes design review processes to ensure technical maturity, basis of issue and affordability. Together, PM TN, PEO C3T and the Network Cross-Functional Team are successfully providing a unified tactical transport network by aligning priorities and resources across numerous programs and efforts to pilot and prototype.

During my assignment, I was immersed in numerous Capability Set 21 efforts, including the integrated tactical network (ITN). Through the ITN framework, the Army is providing battalion-and-below echelons with flexible communications options to better support threat-based environments. As the PM TN liaison embedded within the unified network line of effort, along with efforts to leverage and modernize the upper tactical internet in support of ITN, I was also involved with some of the radio modernization initiatives at the lower tactical echelons. Through the entire ITN selection process—from a scrum implementing the military decision-making process to the existing governance structure for iterative decision-making—I observed the

importance of a synchronized message, ensuring that all of the stakeholders were working toward the same focused goals.

As discussions considered different radio capabilities to support the ITN, the team balanced cost, schedule and performance for programmatic efforts. It also considered the different radio modernization COAs balanced against different needs—such as thwarting near-peer threats, affordability, capabilities, sustainability, interoperability, etc.

As part of the operational planning team for the new Expeditionary Signal Battalion – Enhanced (ESB-E) equipment package, I contributed to the synchronization of information between the Council of Colonels and the General Officer Steering Committees, where leadership made iterative decisions based on Soldier feedback from the ESB-E pilot. The purpose was to home in on the right characteristics to balance capability with cost.

The ESB-E tool suite will be fielded to modernize the Army's legacy expeditionary signal battalions. These units provide network communications capabilities to other units that either don't have their own organic network transport communications



TRAINING FOR INTEGRATION

The 4th Security Force Assistance Brigade used elements of the Army's new integrated tactical network radio capability during its training rotation in June at the Joint Readiness Training Center, Fort Polk, Louisiana. (Photo by U.S. Army)



NIMBLE COMMUNICATIONS

The 50th Expeditionary Signal Battalion – Enhanced pilot unit demonstrated its new lighter, scalable, tailorable and more expeditionary network equipment prototype package to U.S. Army Forces Command leaders in May 2019 at Fort Bragg, North Carolina. (Photo by Amy Walker, PM Tactical Network, PEO C3T)

assets, or require increased network capability to support certain missions. The tool suite comprises an innovative mix of smaller, more mobile equipment for tactical network transport, with significantly reduced complexity and logistical requirements. This modernized commercial off-the-shelf equipment set enables the ESB-Es to rapidly deploy and maneuver across the battlefield and provide robust and resilient network connectivity to the other units it supports.

Following the successful ESB-E pilot effort, I was involved in efforts to identify and implement the path forward for fielding. By working this effort and many other products throughout my year at the Network Cross-Functional Team, I gained an appreciation of the staffing process—all of the coordination that happens at the working levels before putting recommendations in front of the decision-makers—and how the process can support timely modernization decisions while building consensus and capturing differing perspectives.

Looking ahead past ESB-E and other Capability Set 21 solutions, Capability Set 23 builds on those, including science and technology efforts that have transitioned or will transition to PM TN. I took part in initial Capability Set 23 planning discussions as the Army looked to document objectives and approaches for various

design goals, such as the use of commercial low- and medium-earth-orbit satellite constellations and ground terminals, and tailoring the ITN to Stryker and armored units. Of particular importance is the support to Joint All Domain Command and Control—a major concept that will leverage capabilities across all domains and mission partners to achieve battlefield advantage. In support of this concept, the Army plans to deliver network transport and data management solutions to enable the flow of critical situational awareness and sensor data. The goal is to connect sensors (such as aircraft, radar and Soldier-wearable devices), to shooter (the weapon systems used to attack targets), all the way down to the dismounted Soldier.

ENGAGING WITH INDUSTRY

The Army is relying on industry to provide innovative and pioneering technologies to support its network modernization efforts. The Network Cross-Functional Team and PEO C3T have been hosting technical exchange meetings to inform industry of opportunities to partner with the Army in support of capability set requirements as part of the acquisition process.

For instance, the technical solutions discovered through the fourth technical exchange meeting, held in November 2019 in Austin, Texas, will be used to inform Capability Set 23 during its preliminary design review in 2021. More than 670 industry and government partners attended that meeting; ultimately, the Network Cross-Functional Team and PEO C3T selected six topics to return to industry in a call for white papers. PM TN is the acquisition lead for one of those topics: managed multi-orbit satellite communications services.

As the Network Cross-Functional Team liaison, I worked on this effort from the start, beginning with the initial request for white papers in January 2020. Subsequently, I supported the white paper technical evaluations, which resulted in the selection of two vendors' submissions for participation in a "Shark Tank" technical demonstration. At that event, one vendor was chosen to move forward with statement-of-work development and a final proposal. The contract is expected to be awarded this fall. The capability is being developed and evaluated in support of the Capability Set 23 preliminary design review.

LEVERAGING LESSONS LEARNED

My developmental assignment recently ended, and I transitioned to a new position as the assistant product manager for integration at Product Lead Unified Network Capabilities and Integration, a new product office created under PM TN earlier this year. The office consolidates tactical network integration efforts for current,

I found myself immersed in this new developmental role, working side by side with high-ranking Army officers and civilians.

evolving and future capabilities across the PM's portfolio and broader Army modernization efforts.

I am now the lead for the multi-orbit satellite communications services capabilities developed from our technical exchange meetings, and I have the unique opportunity to see the project through on the programmatic side. Since the new product office directly supports the Army's modernization strategy, the experiences and relationships I developed during my time with the Network Cross-Functional Team will undoubtedly help me in my new role.

The numerous tactical network stakeholders, including program offices, the science and technology community and industry, quickly embraced the concept of cross-functional teams. All are now working as unified teams to modernize the Army's network, using both traditional and rapid acquisition processes. The Network Cross-Functional Team is responsible for delivering new capability now, while

planning and laying the groundwork for the future tactical network.

The network team, like its cross-functional counterparts, serves as key integrators, pulling together the requirements, science and technology, and acquisition network communities of interest. Program offices working closely with the cross-functional teams should consider embedding liaison officers to develop the workforce and to help ensure the synchronization of information, processes and developmental efforts to enable the delivery of timely, innovative capabilities that meet Army requirements.

Network cross-functional teams have many members with an acquisition background, but the team itself is not an acquisition organization. A PM liaison officer can help guide the cross-functional teams in the acquisition process and in identifying which technology insertions are possible. Alternatively, the liaison officer can help the PM and PEO to ensure that funding is aligned via the planning, programming, budgeting and execution process. Additionally, the liaison officer can help identify thorough transition plans for maturing technologies as they transfer over to the PMs from the science and technology community. Regardless of their particular responsibilities, a PM liaison officer in a cross-functional team should prepare to roll up their sleeves, learn fast, answer quickly and do good work.

CONCLUSION

Some final thoughts on the relationships between PM and cross-functional teams: The teams should consider affordability when developing new capabilities, apply acquisition rigor by leveraging the years of acquisition experience and knowledge available in the PM office, and ensure that requirements are flexible to allow PMs to explore all possible options and plan for

the future. PMs should align their efforts with cross-functional team efforts, use all acquisition approaches to refine and ultimately field new technology, keep an open mind on technologies that could enable future capabilities, assume acquisition risk and provide honest feedback on the feasibility of cross-functional team efforts.

The PMs and cross-functional teams are leveraging each organization's individual strengths to create strong, integrated, holistic teams, thereby promoting collaboration and rapid delivery. Making use of a liaison officer will help ensure that these teams-of-teams are always synchronized, focused on the same modernization goals and aligning them with requirements and best value. Together, PMs and cross-functional teams are building solid, lasting relationships across all levels of leadership, the stakeholder communities and industry, ensuring success in their ultimate mission—to deliver a modernized force capable of multidomain operations by 2028.

For more information, go to the PEO C3T website at <http://peoc3t.army.mil/c3t/> or contact the PEO C3T Public Affairs Office at 443-395-6489 or usarmy.APG.peo-c3t.mbx.pao-peoc3t@mail.mil.

TYLER J. COOK is the assistant product manager for integration, assigned to PEO C3T's Product Lead for Unified Network Capabilities and Integration within the Project Manager for Tactical Network. He will soon complete an M.E. in systems engineering from Stevens Institute of Technology, and he holds a B.S. in mechanical engineering from Penn State University. He is Level III certified in engineering and holds a graduate certificate in systems supportability engineering.

SECURITY COOPERATION GOES PRO

New workforce certification and school build on professional development programs in recently designated acquisition specialty.

by David A. Williams and Cathy VanderMaarel

Working in security cooperation isn't like any other job in defense acquisition. It takes certain distinct skills and knowledge to build the capability and capacity of foreign security forces to respond to challenges they share with the United States.

For one thing, security cooperation professionals must understand their role in advancing U.S. national security and foreign policy interests—planning, executing and evaluating the programs and activities that further those objectives. Fulfilling such a role requires specialized training, experience and continuous learning.

The Army acquisition community has had these, including professional certification standards, at least since the passage in 1990 of the Defense Acquisition Workforce Improvement Act. Now, certification is coming to the 20,000-strong security cooperation community.

While security cooperation has long been a feature of U.S. relations with foreign militaries, authorities for such programs have been numerous and confusing, spanning permanent law and temporary provisions. The National Defense Authorization Act for Fiscal Year 2017 contains a mandate to streamline existing authorities, reform DOD's management of the security cooperation workforce and facilitate congressional oversight.

Secretary of Defense Dr. Mark T. Esper said in July that one of the department's priorities "is to develop a coordinated strategy for allies and partners, recognizing that these like-minded nations are an unmatched advantage that China and Russia do not have. We launched a whole-of-DOD integrated approach that includes senior leader engagements with key countries and security cooperation programs."

Thus begins a new era for those working in security cooperation, with major changes to come.

EDUCATION AND CERTIFICATION

In response to the legislation, the Defense Security Cooperation Agency has established the Defense Security Cooperation University—with campuses in Arlington, Virginia, and Wright-Patterson Air Force Base, Ohio—and launched the Department of Defense Security Cooperation Workforce Certification Program. Because of the coronavirus pandemic, in-person classes were adjusted in 2020. By offering online options, Cara Abercrombie, the Defense Security Cooperation University president, said the staff can now offer three times as many courses to the workforce online as were previously available. She said offering virtual learning “was a long-term goal. We wanted to offer a 21st-century education online and it was something we were toying with in a hybrid way,” so they invested in learning management system upgrades before the pandemic.

The certification program, along with Defense Security Cooperation University training and education, is based on nine security-cooperation competencies and 58 job tasks developed by the Defense Civilian Personnel Advisory Service. The program has three elements: training, experience and continuous learning, for positions categorized in one of five areas of concentration:

- **Security-cooperation planning, oversight and execution management:** Broad planning, policy development, oversight and execution of security cooperation programs and activities.
- **Security-cooperation case life cycle management:** Security-assistance policy and procedures, foreign military sales and building partner capacity cases.
- **Security-cooperation organization operations and management:** Security-cooperation offices at U.S. embassies.
- **Security-cooperation execution-support management:** Support security cooperation programs and activities.

- **Security-cooperation acquisition management:** Support acquisition in foreign military sales and building partner capacity cases, international acquisition or international armaments cooperation.

Each area of concentration has four levels of certification that personnel must meet based on the requirements of their specific position. Certification requirements must be satisfied within a designated time, as follows:

- Basic – One year.
- Intermediate – Three years.
- Advanced – Five years.
- Expert – Seven years.

For the current workforce, the time period begins on Jan. 1, 2021; for those who join the security cooperation workforce after that, it begins the date they enter their position.

THE ARMY’S EFFORTS

The Office of the Deputy Assistant Secretary of the Army for Defense Exports and Cooperation (DASA (DE&C)) and Headquarters, Department of the Army (HQDA) G-3/5 are preparing for Army implementation of the program before it becomes mandatory and certification deadlines go into effect through the development of the “HQDA Memo: Department of the Army Implementation of the DOD SCW Certification Program” (signed Sept. 21 by Jeffrey S. White, principal deputy assistant secretary of the Army for acquisition, logistics and technology). The DOD program will be augmented by existing Army security cooperation workforce training and professional development.



OBSERVATION LEARNING

Security cooperation isn’t just a job—it requires training, experience and continuous learning to execute programs that advance theater and national security objectives. (Photo by Staff Sgt. Brian Ragin, 3rd Infantry Division Public Affairs)

SECURITY COOPERATION OR SECURITY ASSISTANCE?

The terms security cooperation and security assistance are often used interchangeably, but there are important differences.

The security cooperation workforce comprises DOD civilians and military personnel in positions that interact, or support those who interact, with foreign countries' security institutions to:

- Build and develop the security capabilities of allied and friendly nations for self-defense and multinational operations.
- Provide the armed forces with access to the foreign country during peacetime or a contingency operation.
- Build relationships that promote specific U.S. security interests.

The security cooperation workforce cuts across multiple military branches and specialties, civilian career programs and occupational series. It numbers more than 20,000 DOD personnel, of whom 4,500 are with the Army and 1,500 are in joint billets that the Army fills. The ratio of civilian to military personnel is 4-to-1.

The security assistance workforce is a subset of the security cooperation workforce, comprising billets or positions that routinely perform security cooperation functions whereby the U.S. provides defense articles, military training and other defense-related services by grant, lease, loan, credit or cash sales to further national policies and objectives. Many in the security assistance workforce are also in the acquisition workforce. All told, it numbers more than 4,000 members of the security cooperation workforce.

(SOURCES: 10 U.S.C. § 301 (Section 301); DOD Dictionary of Military and Associated Terms; and the Security Cooperation Workforce Development Database.)

While security cooperation has long been a feature of U.S. relations with foreign militaries, authorities for such programs have been numerous and confusing, spanning permanent law and temporary provisions.

DASA (DE&C) has been conducting the U.S. Army Security Assistance Workforce Rotational Assignment Program since 2015. Selected personnel execute temporary duty assignments of 60 to 179 days between Feb. 1 and Sept. 30 each fiscal year. More than 60 security assistance workforce personnel have completed developmental assignments at the U.S. Department of State, the DOD's Security Cooperation Offices and Defense Security Cooperation Agency, and in Air Force and Army positions since the program's inception. In the 2021 fiscal year, DASA (DE&C) plans to expand opportunities to geographic combatant commands, the Navy, HQDA G-3/5 and the Army service component commands.

Since 2019, DASA (DE&C) has also managed the Security Assistance Workforce Personnel Exchange Program, which allows commands and organizations to trade personnel—a one-for-one exchange between organizations, versus one organization receiving an individual for a temporary duty assignment—for 60-179 days between Feb. 1 and Sept. 30 each fiscal year.

The two programs provide personnel in the security cooperation workforce with opportunities to enhance their competencies by performing duties in other occupational, functional and organizational elements. "We've had such a positive response from past and current participants in the programs, and we're excited to get more participants to experience security cooperation activities not just in the Defense Department, but also with our interagency colleagues," said Elizabeth Wilson, the DASA (DE&C).

DASA (DE&C) is also developing Army-centric security assistance training and tools to help the workforce manage security



APPLYING TRAINING

The Department of Defense Security Cooperation Workforce Certification Program is based on nine security cooperation competencies and 58 job tasks. It has three elements: training, experience and continuous learning. (Photo by Richard Bumgardner, U.S. Army Security Assistance Command Public Affairs)

assistance, foreign military sales and building partner capacity programs—the broad set of missions, programs, activities and authorities intended to improve the ability of other nations to achieve those security-oriented goals they share with the United States. DASA (DE&C) is collecting data and conducting assessments across the Army security assistance enterprise in fiscal year 2020 to determine unique Army training requirements. The resulting Army-centric security assistance training and tools will complement Defense Security Cooperation University training, some of which may qualify for continuous learning credit in the certification program.

HOW TO GET STARTED

Army commands and organizations have completed the data input into the DOD Security Cooperation Workforce Development Database to enable Army security cooperation personnel to see their area of concentration, certification level, certification requirements and status. To view the database, which requires a Common Access Card (CAC), go to <https://www.dscu.mil>, click on the “Certification Center” icon and explore the “Training Report” and “Certification Status” links.

Recognizing that many personnel in the current workforce have completed courses related to security cooperation in the past, the certification program gives “new” course credit for the completion of legacy courses that meet equivalency standards. More information is available at: https://www.dscu.mil/documents/sc_cert/Legacy_Course_Credit_Equivalency_Table_for_Required_Courses.pdf.

For more information on Army-specific security cooperation programs, go to www.dasadec.army.mil/portal (CAC-enabled) or contact the training team using the form at www.dasadec.army.mil/Contact-Us/.

DAVID A. WILLIAMS is the lead for Army security cooperation workforce development and has worked in DASA (DE&C) since 2011. A retired U.S. Marine Corps officer, he has served in security cooperation positions since 2006. He holds a B.S. in industrial distribution; a Master of Military Science from the Marine Corps Command and Staff College; and a Master of International Relations from Troy University. He obtained Level II DOD International Affairs Certification and has met the requirements for Intermediate Level Security Cooperation Workforce Certification in the Security Cooperation Execution Support Area of Concentration.

CATHY VANDERMAAREL is a career Army public affairs civilian, having started in the field in 2003. She has served as a public affairs strategist at DASA (DE&C) since March 2020. She holds a Master of Public Administration from Norwich University and a B.A. in communications from the University of South Carolina. She has attained the Intermediate Level Security Cooperation Workforce Certification in the Security Cooperation Execution Support Area of Concentration.



MAJ. TOM BEYERL

COMMAND/ORGANIZATION:

U.S. Army Acquisition Support Center,
Director for Acquisition Career Management,
Strategy and Policy Branch

TITLE: Functional Area 51 proponency officer

YEARS OF SERVICE IN WORKFORCE: 8

YEARS OF MILITARY SERVICE: 16

DAWIA CERTIFICATIONS: Level II
in program management

EDUCATION: M.S. in mechanical engineering, Georgia Southern University; M.S. in administration, Central Michigan University; B.S. in mechanical engineering, Norwich University

AWARDS: Bronze Star (2nd award), Meritorious Service Medal (2nd award), Army Commendation Medal (3rd award), Army Achievement Medal

DRIVING CHANGE IN THE AAW

Maj. Tom Beyerl is a man of action. An optimist by nature and an engineer by training, he brings an almost unnatural amount of energy to his work. Picture the Energizer bunny, but in uniform. “If you’re a Myers-Briggs [Type Indicator] person, I’m an ENTJ [extroverted, intuitive, thinking and judging],” he said. “It’s kind of a weird combination.” According to 16 Personalities, a personality testing company, ENTJs are “decisive people who love momentum and accomplishment.” They “gather information to construct their creative visions but rarely hesitate for long before acting on them.” That should sound familiar to anyone who knows Beyerl.

He decided to join the Army Acquisition Workforce (AAW) after a positive experience conducting a limited user test with his Stryker rifle company. “This was my first interaction with Army Acquisition Corps [AAC] officers,” he said. “I was extremely impressed with the impact they had on system development.” An engineer through and through, Beyerl is naturally curious and has a passion for solving problems. “I always wanted the opportunity to work toward developing better ‘kit,’” he said, referring to the equipment carried by Soldiers in the field, “and the Acquisition Corps offered that chance.” His first AAW position was at the Program Executive Office (PEO) for Soldier, where he was responsible for major upgrades in laser targeting devices and rangefinders for Product Manager Soldier Precision Targeting Devices.

Today, Beyerl works as a proponency officer within the Strategy and Policy Branch in the Office of the Director of Acquisition Career Management (DACM). His primary responsibility is developing and staffing programs to help the AAW keep pace with the ever-changing landscape of acquisition. “I am responsible for ensuring the Human Capital Strategic Plan captures senior leader guidance and can ... ensure our workforce recruits, develops and retains” the necessary talent. He also provides support to a broad array of military and civilian talent management initiatives.

So, what does he enjoy most about his work? “My greatest satisfaction, as part of this great team, is the opportunity to contribute to talent management changes which will have lasting effects on the quality and performance of our workforce,” he said. Not that he withholds career advice from those outside the AAW—he’s too energetic to keep a good idea to himself. “I once recruited a Marine pilot in engineering school,” he laughed. Beyerl was in graduate school and had been talking with a classmate who was concerned about the job market. “Unless you found a way to make yourself stand apart, it would be a difficult, competitive market,” he said. So Beyerl sold him on the idea of commissioning as a Marine Corps pilot, then returning to the civilian job market later. Among his selling points, “You get to fly planes—there is nothing cooler. You’ll be more marketable than your peers if you decide to get out of the military after your commitment. And if you like it, you get to stay!” Pragmatic advice, delivered with a bit of salesman’s flair.

But like any good engineer, Beyerl knows talent advancement is, ultimately, all about the data. “Talent management is such a qualitative subject that it can be hard to



LEADERS IN THE MAKING

Beyerl, an advocate of talent management, has led by example throughout his career. He and about 30 captains got an introduction to leadership at a strategic, or enterprise, level in the summer of 2013, graduating from the Strategic Studies Fellows Program of the University of North Carolina at Chapel Hill's Institute for Defense and Business. (U.S. Army photo)

deduce the underlying indicators of success,” he explained. “In reality, though, any successful training or personnel initiative is supported by hard data, and that allows us to put senior leader intent into action.” He believes the Army’s senior leaders are looking for speed and innovation, and he understands that sometimes things don’t go according to plan—but that’s just part of the process.

“Innovation requires failure,” he said. If the Army is going to be truly innovative, it must also be able to accept failure as an occasional result, but that can be difficult. “People like [billionaire inventor] Elon Musk can just give up on projects that don’t work, but the Army can’t do that,” he said. Because of time and resources invested, “there can be institutional friction with admitting that an idea didn’t work.” In other words, no one wants to give bad news to their boss, so they may try to make it work anyway. “Everyone wants to help Soldiers,” he said. “The whole team.” But becoming more innovative will require the Army to be more accepting of failure in certain circumstances, Beyerl said.

The most important lesson he has learned in his career is that innovation can come from unexpected places. “It’s really impressive how innovative our Soldiers can be if we foster an environment where their ideas are welcomed,” he said. In fact, some of the

most successful projects he has worked on have come from good ideas generated at the tactical level. During a three-year assignment at the Army’s Asymmetric Warfare Group (AWG), he said he would often see young Soldiers come up with unique solutions to problems. “They would quickly develop nonstandard ways to use their equipment to solve emerging challenges.” He served as a test and evaluation officer at AWG before taking over as chief of concepts. It was “my most valuable career-broadening experience,” he said. He and his team worked to identify challenges, quickly prototype solutions and then determine their effectiveness in various environments. The experience was rewarding for Beyerl, and introduced him to a whole host of Army stakeholders, operational partners and dedicated Soldiers and civilians.

At this point in his career, he knows a bit about finding his professional niche, and he shares that lesson with others. “The best advice I have for young acquisition officers and civilians is to follow your passion across different career fields,” he said. “There are so many opportunities to excel in this workforce, that many different paths can lead you to a successful and rewarding career.” There is no single road map to success, he said. Follow your passion and you will find the right path.

—ELLEN SUMMEY

ON THE MOVE



DEPUTY ASSISTANT SECRETARY OF THE ARMY FOR DEFENSE EXPORTS AND COOPERATION

1: DASA (DE&C) WELCOMES NEW LEADER

Elizabeth F. "Liz" Wilson assumed the role of deputy assistant secretary of the Army for defense exports and cooperation (DASA (DE&C)) in May. She is the Army principal responsible for security assistance and armaments cooperation, export policies, direct commercial sales of Army defense articles, and international cooperative research, development and acquisition. These programs employ over 3,100 Army Soldiers and civilians and exceed \$15 billion annually in sales and cooperative efforts with over 150 foreign countries.

Wilson previously served as the deputy assistant secretary of the Army for marketing for two years. Before that, she was the executive director of the DOD and Veterans Affairs Collaboration Office as DOD's central point of contact for the White House, Congress and the Department of Veterans Affairs regarding service member and veteran programs. Wilson's first position in the Senior Executive Service, to which she was appointed in December 2012, was as principal director of manpower and personnel in the Office of the Assistant Secretary of Defense for Reserve Affairs.

Wilson retired at the rank of colonel in June 2007 after 26 years of active-duty service in the Army, culminating as deputy director in the Army G-1 Policy Directorate. She is a graduate of the U.S. Army War College.

U.S. ARMY MATERIEL COMMAND

2: DALY TAKES CHARGE AT AMC

Gen. Edward M. Daly, left, takes command of the U.S. Army Materiel Command (AMC) as he returns the AMC flag to **Command Sgt. Maj. Rodger Mansker** during a passing of the colors ceremony July 2 at Redstone Arsenal, Alabama. The passing of the colors was part of the change of command ceremony, which included previous AMC Commander **Gen. Gustave F. Perna** and Army Chief of Staff **Gen. James C. McConville**. Perna, the 19th commanding general (CG) of AMC, relinquished command and is serving as the chief operations officer for Operation Warp Speed, the Trump administration's program to accelerate the development, manufacturing and distribution of COVID-19 vaccines. Daly, AMC's 20th CG, previously served as AMC's deputy CG. (Photo by Doug Brewster, AMC)



3: AMC WELCOMES NEW CSM

AMC CG **Gen. Edward M. Daly**, left, passed the colors to **Command Sgt. Maj. Alberto Delgado**, right, during a change of responsibility ceremony July 23 at Redstone Arsenal. **Command Sgt. Maj. Rodger Mansker**, AMC’s 16th command sergeant major, who relinquished responsibility to Delgado, retired after nearly 35 years of service. Delgado, AMC’s 17th command sergeant major, previously served as U.S. Army North command sergeant major. Daly, who presided over the ceremony, praised both Delgado and Mansker, describing them as tremendous Soldiers, trainers, leaders and warriors. “Both Command Sgt. Maj. Mansker and Command Sgt. Maj. Delgado live the NCO creed each and every day,” he said. (Photo by Eben Boothby, AMC)

4: WALKER GAINS THIRD STAR

Lt. Gen. Flem B. “Donnie” Walker Jr., left, unfurls the Army three-star flag that will hang in his office and at official events during his assignment as U.S. Army Materiel Command’s deputy CG. Walker’s promotion ceremony was held at AMC headquarters July 2. Walker was previously AMC’s deputy chief of staff for operations. **Maj. Gen. Charles R. Hamilton** has taken over as AMC’s G-3 after serving as CG of the 8th Theater Sustainment Command, Fort Shafter, Hawaii. (Photo by Doug Brewster, AMC)

5: NEW RESOURCE MANAGEMENT DIRECTOR

AMC welcomed a new deputy chief of staff for resource management, who will be responsible for overseeing more than \$500 billion annually for the command. **Christina Freese** was appointed as a member of the Senior Executive Service during a ceremony March 11 at AMC headquarters. “Freese represents the commitment, competence and high character that makes a great leader,” **Gen. Gustave F. Perna**, then-CG of AMC, said during the ceremony. Most recently, she served as business director for the U.S. Army Corps of Engineers at the Engineering Support Center, Huntsville, Alabama. (Photo by Doug Brewster, AMC)

6: AMC GAINS ASSISTANT DEPUTY COS, G-8

AMC also welcomed **Mike Cook** as assistant deputy chief of staff for resource management, G-8. He was promoted to the ranks of the Senior Executive Service and assumed the resource management position on June 24 after serving as deputy G-8 for U.S. Army Space and Missile Defense Command. Executive Deputy to the Commanding General **Lisha H. Adams** said, “Undoubtedly, [Cook’s] credentials mark him as an exceptional choice to lead AMC G-8 alongside **Mrs. [Christina] Freese**.” (Photo by Doug Brewster, AMC)

PROGRAM EXECUTIVE OFFICE FOR AVIATION



1: NEW LEADERSHIP AT PEO AVIATION

Brig. Gen. Robert L. Barrie Jr., right, recites the oath of office administered by **Maj. Gen. Thomas H. Todd III**, (now a lieutenant general and deputy commanding general for acquisition and systems management, Army Futures Command) during Barrie's promotion ceremony on June 2. Barrie later assumed the charter to become the 13th program executive officer (PEO) for Aviation during a private ceremony July 1 on Redstone Arsenal, Alabama. Barrie had served as deputy PEO since January under **Patrick H. Mason**, who will return to his former role as deputy PEO. PEO Aviation comprises 10 project offices.

Dr. Bruce D. Jette, assistant secretary of the Army for acquisition, logistics and technology (ASA(ALT)), virtually presided over the assumption of charter ceremony via video. "Rob Barrie is an accomplished officer who has held several high-profile and challenging assignments," Jette was quoted in the Redstone Rocket as saying. "He not only understands



aviation well, he also understands my world, having served with distinction as my chief of staff."

Barrie was commissioned as an aviation officer after graduation from the United States Military Academy in 1990. He held staff and command positions and later was assigned to PEO Aviation, where he served as assistant product manager for the UH-60M Product Office and later as the executive officer to the PEO. From 2008 to 2011, Barrie was product manager for the Joint Air-to-Ground Missile with the PEO for Missiles and Space. After an assignment at the Pentagon as executive officer to the principal military deputy to the ASA(ALT), he returned to PEO Aviation as Project Manager for Cargo Helicopters, followed by an assignment as Jette's chief of staff.

Barrie has an M.S. in aeronautical engineering from the Naval Postgraduate School and a B.S. in aerospace engineering from the U.S. Military Academy at West Point.

Jette praised Mason for his service as PEO, which, he was quoted in the Redstone Rocket as saying, "requires a special blend of skills, especially in today's environment. The job requires strong leadership, sound business judgment, effective communication skills, integrity and technical expertise."

Mason, he noted, "effectively managed an annual budget of \$8 billion, led a global workforce of 3,000 military, civilian and contractor professionals, and was responsible for more than 60 programs and the largest number of FMS [foreign military sales] cases in the entire Department of Defense." (Photos by Michelle Miller, PEO Aviation)

2: CH-47 MODERNIZATION CHANGE OF CHARTER

PEO Aviation welcomed **Lt. Col. David Hnyda**, left, during a May 14 virtual change of charter ceremony conducted by the Cargo Helicopters Project Office. Hnyda assumed responsibility as the product manager for CH-47 Modernization from **Lt. Col. John Schmitt**, right. **Col. Al Niles**, center, Cargo Helicopters project manager, presided over the virtual event. Hnyda previously served as the deputy associate director of aviation development for the U.S. Army Combat Capabilities Development Command Aviation and Missile Center, Moffett Field, California. Schmitt retired with more than 20 years of service. (Photo by PEO Aviation Public Affairs)

3: NEW LEAD FOR CH-47 BLOCK I PROGRAM

Col. Al Niles, center, project manager for the Chinook Cargo Helicopter Office, officiated a virtual change of charter ceremony July 1 for the CH-47F Improved Cargo Helicopter Product Office. Incoming Product Manager **Lt. Col. Travis Blaschke**, left, assumed responsibility from **Lt. Col. Danielle Medaglia**, who had served as the product manager since 2017. As the product manager for CH-47 modernization, Blaschke will be responsible for overseeing the development, integration and program management of the CH-47F Block I program. (Photo by PEO Aviation Public Affairs)



4: NEW PRODUCT LEAD AT SOLDIER UNMANNED AIRCRAFT SYSTEMS

Dr. Carlos Correia, left, accepted responsibility as the product lead for the Soldier Unmanned Aircraft Systems (SUAS) Product Office from **Margaret Patton** in a ceremony hosted by **Col. Joseph Anderson**, project manager for Unmanned Aircraft Systems, June 15 on Redstone Arsenal. Before this assignment, Correia was the deputy product lead for SUAS. Patton is transitioning to her next assignment as the deputy chief of staff for PEO Aviation. (Photo by David Hylton, PEO Aviation)



5: ASSISTANT PEO RETIRES AFTER 33 YEARS

Craig Maurice, left, accepts a set of framed PEO Aviation project office coins from **Patrick H. Mason**, then-PEO for Aviation, during Maurice's retirement ceremony May 28 at Redstone Arsenal. Maurice retired after more than 33 years of government civil service. He began his career in 1987 as an Army civilian with the Aviation Research, Development and Engineering Center in St. Louis. Maurice served in a number of positions of increasing responsibility until his last assignment as PEO Aviation's assistant PEO for operations. (Photo by David Hylton, PEO Aviation)



6: SPECIAL PROJECTS LEAD PROMOTED

Lt. Col. Michael Rigney recites the oath of office, administered by then-**Maj. Gen. Thomas H. Todd III** (now a lieutenant general and deputy commanding general for acquisition and systems management, Army Futures Command) during Rigney's promotion ceremony June 12 at the PEO Aviation campus on Redstone Arsenal. Rigney recently served as the lead of special projects for PEO Aviation. His previous assignments include executive officer for PEO Aviation; assistant product manager for the Improved Turbine Engine Program and product lead for the Degraded Visual Environment Brownout Rotorcraft Enhancement System product office. After a one-year Training With Industry assignment, Rigney will return to PEO Aviation. (Photo by Michelle Miller, PEO Aviation)





PROGRAM EXECUTIVE OFFICE FOR SIMULATION, TRAINING AND INSTRUMENTATION

1: PEO STRI WELCOMES NEW LEADER

Karen D.H. Saunders took over the leadership responsibilities for the Program Executive Office for Simulation, Training and Instrumentation (PEO STRI) during a July 24 assumption of charter ceremony. A member of the Senior Executive Service, she joined the PEO after serving as chief of staff for the undersecretary of defense for acquisition and sustainment (USD(A&S)). In that capacity, she was responsible to the USD(A&S) for daily management and operation on all matters pertaining to acquisition; contract administration; logistics and materiel readiness; installations, environment and operational energy; chemical, biological and nuclear weapons; the acquisition workforce; and the defense industrial base.

In her new role, she will oversee the execution of a multibillion-dollar program annually, and will lead a workforce of more than 1,000 military, government civilian and service support contractors. PEO STRI also manages foreign military sales programs that support more than 65 partner countries.

A retired Army officer with 30 years of service, Saunders was commissioned as a Military Intelligence Corps second lieutenant upon graduation from Oklahoma State University. She held a variety of command and staff assignments in military intelligence and in operations research and systems analysis before joining the Army Acquisition Corps. Her culminating assignment in Army acquisition before she retired in December 2014 as a colonel was as the chief of staff in the Office of the Assistant Secretary of the Army for Acquisition, Logistics and Technology. Before that, she served on the Office of the Secretary of Defense's staff and in numerous roles for the Combined Security Transition Command – Afghanistan. Saunders' other acquisition assignments included project director and project manager, both at PEO STRI, and product manager for Future Combat System – Battle Command.

Saunders holds an M.S. in computer science, with a focus in artificial intelligence and robotics, from the Naval Postgraduate School, an

M.S. in national security strategy from the National War College and a B.S. in mathematics. She is Level III certified in program management.

Saunders takes over leadership of PEO STRI from Senior Executive Service member **Timothy F. Bishop**, who served briefly as acting program executive officer after being deputy PEO since January 2019. He continues as deputy PEO.

2: SOLDIER TRAINING LEADERSHIP CHANGE

PEO STRI welcomed a new leader for the Project Manager for Soldier Training (PM ST) in a change of charter ceremony June 17. During the ceremony, the outgoing project manager, **Col. G. Scott McLeod**, left, passed the charter to **Col. Cory Berg**, right, who will lead PM ST in its mission of improving Soldier readiness using realistic training environments and equipment at home stations, combat training centers and deployed locations.

3: MMS GETS NEW PM, MOVES TO DHA

Jude Tomasello, left, assumed the charter of the Joint Project Manager for Medical Modeling and Simulation (JPM MMS) during a June 26 ceremony, taking over for **Col. Scott McIntosh**, right. JPM MMS, which had been part of PEO STRI since 2016, was then transferred to the Defense Health Agency (DHA) in August. The project has succeeded in fielding high-tech medical simulations for Soldiers, with the singular goal of saving lives. Moving to the DHA will enhance the team's mission to promote and better integrate medical simulation capability across the Military Health System.

4: SYNTHETIC ENVIRONMENT CHANGE OF CHARTER

Col. Nicole Reinhardt, left, assumed the leadership role for Project Manager, Synthetic Environment (PM SE), replacing **Col. Marcus Varnadore**, right, in a July 8 change of charter ceremony. PM SE provides relevant integrated modeling and simulation capabilities to achieve Army readiness. It merges virtual, constructive and gaming products into one structure.

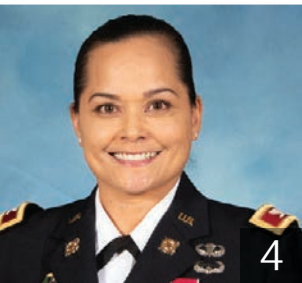
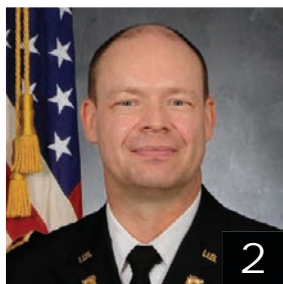



U.S. ARMY AVIATION AND MISSILE COMMAND

5: MARTIN TAKES OVER AS CHIEF OF STAFF

Col. Richard Martin assumed the duties as the U.S. Army Aviation and Missile Command (AMCOM) chief of staff in a July 20 virtual ceremony hosted by **Maj. Gen. K. Todd Royar**, commandeering general of U.S. Army AMCOM. Martin previously served as commander of the Aviation Center Logistics Command, Fort Rucker, Alabama. AMCOM develops and delivers responsive aviation, missile and calibration materiel readiness to the Army in order to optimize joint warfighter capabilities at the point of need.

His previous assignments include three deployments in support of Operation Iraqi Freedom and one in support of Operation Enduring Freedom; commander of the 601st Aviation Support Battalion in the Combat Aviation Brigade, 1st Infantry Division, Fort Riley, Kansas; and seminar leader and instructor for the Advanced Military Studies Program at the School of Advanced Military Studies, Fort Leavenworth, Kansas.

Martin holds an M.A. in business and organizational security studies from Webster University; two Master of Military Arts and Sciences degrees from the School of Advanced Military Studies, part of the U.S. Army Command and General Staff College; and a B.A. in sociology from the University of North Carolina at Chapel Hill. His professional military education includes the Aviation Officer Basic Course, the Aviation Captains Career Course, the Combined Arms Staff Services School, the Command and General Staff College's Intermediate Level Education and the School of Advanced Military Studies Advanced Military Studies Program, as well as the Army's Strategic Leadership Studies Program.

6: AVIATION CENTER LOGISTICS COMMAND WELCOMES LEADER

Col. Stephen Owen assumed command of the Aviation Center Logistics Command, Fort Rucker, Alabama, June 23. **Maj. Gen. K. Todd Royar**, commander of the U.S. Army Aviation and Missile Command, hosted the virtual ceremony from the headquarters on Redstone Arsenal in Huntsville, Alabama.

Owen previously served as director for the U.S. Army Aviation Center of Excellence Directorate of Training and Doctrine. The Littleton, Colorado, native commanded the 122nd Aviation Support Battalion, 82nd Combat Aviation Brigade, 82nd Airborne Division. Following battalion command, Owen was assigned as an adviser to the Saudi Arabian National Guard in Riyadh, Saudi Arabia.

He holds an M.A. in military studies from American Military University and a Master of Strategic Studies from the U.S. Army War College. He also earned a bachelor's degree from Brigham Young University. Owen's professional military education includes the Aviation Officer Basic Course, the Aviation Captains Career Course, the Combined Arms Staff Services School, the Command and General Staff College's Intermediate Level Education and the U.S. Army War College. Owen is a Senior Army Aviator qualified in the CH-47F Chinook helicopter and is a graduate of the CH-47D Instructor Pilot and Maintenance Test Pilot courses. He is also a graduate of both the Airborne and Air Assault courses.

The Aviation Center Logistics Command provides full-spectrum maintenance, supply and contractor oversight to ensure availability for all Aviation training mission requirements in support of the U.S. Army Training and Doctrine Command at Fort Rucker, Alabama, and Fort Benning, Georgia.

U.S. ARMY COMBAT CAPABILITIES DEVELOPMENT COMMAND

7: CCDC WELCOMES NEW FORWARD ELEMENT CENTER DIRECTOR

Col. Jenny Stacy recently became the director for U.S. Army Combat Capabilities Development Command (CCDC) Forward Element Center – Atlantic in Stuttgart, Germany. Before this role, Stacy was the senior acquisition adviser to the Enterprise-Information-Technology-as-a-Service pilot program with the U.S. Army Cyber Command.

Stacy's area of responsibility includes Europe, South Africa, Israel, Turkey and the United Arab Emirates. As director, she leads a basic and applied research team, three international technology centers (in the United Kingdom, France and Germany) and three Field Assistance in Science and Technology teams (U.S. Army Europe, 7th Army Training Command and U.S. Army Africa).

She has an M.S. in computer science from the Naval Postgraduate School; her thesis, "Detecting Age in Online Chat," received the Gary Kildall Award for computing innovation. She also holds a B.S. in computer science from the United States Military Academy at West Point. In 2019, she received the Product Management Professional of the Year award, one of the annual Army Acquisition Executive Excellence in Leadership Awards. She is a member of the Army Acquisition Corps, and is Level III certified in program management and Level II certified in information technology.

U.S. ARMY SECURITY ASSISTANCE COMMAND

1: NEW EXECUTIVE DIRECTOR AT USASAC

Dr. Myra Gray assumed duties as the U.S. Army Security Assistance Command (USASAC) executive director June 2 at the command's Redstone Arsenal headquarters in Huntsville, Alabama. She will serve as executive director until USASAC receives its new commanding general (CG), at which time she will transition to her position as deputy to the CG. USASAC implements approved U.S. Army security assistance programs, including the foreign military sales (FMS) of defense articles and services to eligible foreign governments. The command manages FMS cases with 151 countries, with a total value exceeding \$200 billion.



2: DRUSHAL RELINQUISHES COMMAND

Maj. Gen. Jeffrey W. Drushal relinquished command of USASAC during a ceremony June 2 at Redstone Arsenal, with **Lt. Gen. Edward M. Daly**, then-deputy CG of AMC, officiating. "When Jeff assumed command almost two years ago in 2018, he brought with him a reputation as a premier and great logistician ... so naturally **Gen. Gus Perna** [then-AMC commanding general] had great expectations for you and this organization," said Daly. "And let me just tell you, you absolutely exceeded his expectations." USASAC is a major subordinate command of AMC.

Drushal's next assignment is at U.S. Central Command, MacDill Air Force Base, Florida, where he will serve as the J-4 (Logistics). (Photo by Richard Bumgardner, USASAC)

Daly highlighted the critical nature of high-priority foreign military sales executed under Drushal. "More than 7,000 cases validated, worth \$204 billion in 166 countries," he said. "This translates to well-equipped, capable and ready allies and partners around the world—High Mobility Artillery Rocket Systems and Patriot Advanced Capability missiles in Poland, Kiowa helicopters in Greece, Stryker command vehicles in Thailand, unmanned aerial systems in Nigeria, logistics support vehicles in Argentina and aircraft and LAVs [Light Armored Vehicles] in Saudi Arabia. Impressive, impressive, work ... a difference made and a game changer," said Daly.

3: CSM RETIRES AFTER 33 YEARS

The USASAC and Army Security Assistance Enterprise said goodbye and best wishes to USASAC's departing **Command Sgt. Maj. Gene E. Canada**, July 17. **Gen. Edward M. Daly**, left, commanding general of AMC, hosted the event as Canada retired after more than 33 years of service to the Army and nation. "I am honored to be able to preside over this ceremony," said Daly. "It's bittersweet, as on one hand we are going to bid farewell to a great warrior, a great Soldier, a great leader and a great man of character and, on the other hand, we are here to celebrate this great noncommissioned officer's career after 33 years in the U.S. Army."

Daly said that Canada's distinguished career didn't happen by chance, rather that it was based on a rich tradition of service in Canada's family. Canada retires as only the third command sergeant major in USASAC's 55-year history. (Photos by Terri Stover, USASAC)

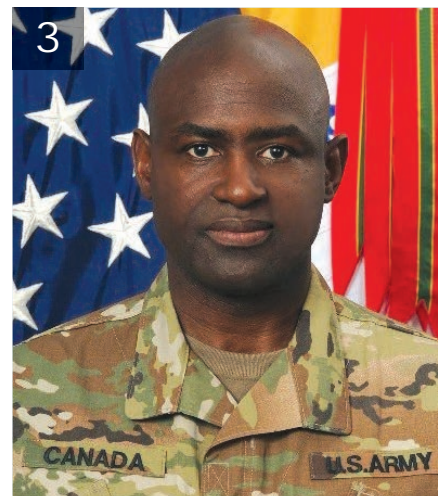



U.S. ARMY SUSTAINMENT COMMAND

4: ASC WELCOMES NEW CG

In a change of command ceremony June 24 at Rock Island Arsenal, Illinois, **Maj. Gen. Daniel G. Mitchell**, left, accepted the flag of command for U.S. Army Sustainment Command (ASC) from **Lt. Gen. Thomas S. James Jr.**, commanding general (CG) of First Army. James was acting as a proxy for **Gen. Gustave F. Perna**, then-19th CG of U.S. Army Materiel Command, who presided over the ceremony via live video link. ASC is a major subordinate command of Army Materiel Command.

Mitchell, former CG of U.S. Army Tank-automotive and Armaments Command, replaces **Maj. Gen. Steven A. Shapiro**, who retired after a 35-year military career. Shapiro was honored at a ceremony that followed the change of command. Mitchell was previously assigned to ASC headquarters from July 2013 to June 2014. (Photo by Linda Lambiotte, ASC)

U.S. ARMY TANK-AUTOMOTIVE AND ARMAMENTS COMMAND

5: TACOM CHANGE OF COMMAND

Brig. Gen. Darren Werner, left, incoming commanding general (CG) of U.S. Army Tank-automotive and Armaments Command (TACOM), takes the unit colors from **Maj. Gen. Brian Cummings**, program executive officer for Ground Combat Systems, who was standing in for **Gen. Gustave F. Perna**, then-CG of U.S. Army Materiel Command, during a virtual change of command ceremony June 12 at Detroit Arsenal, Michigan. TACOM is a major subordinate command of Army Materiel Command. Werner replaces **Maj. Gen. Daniel G. Mitchell**, who has returned to Rock Island Arsenal as CG of U.S. Army Sustainment Command. (Photo by Scott Wakefield, TACOM)



JOINT MUNITIONS COMMAND

6: CHANGE OF COMMAND FOR JMC

Col. Gavin J. Gardner, left, the new commander for the Joint Munitions Command (JMC), passes the JMC flag to **Lt. Gen. Thomas S. James Jr.**, while **Brig. Gen. Michelle M.T. Letcher**, the outgoing JMC commander, looks on during a change of command ceremony June 11 at Rock Island Arsenal, Illinois. (Photo by JMC Public Affairs)





1



2

MILITARY SURFACE DEPLOYMENT AND DISTRIBUTION COMMAND

1: SDDC WELCOMES NEW CG

Brig. Gen. Heidi J. Hoyle, the Military Surface Deployment and Distribution Command's (SDDC) 22nd commanding general, takes the guidon from **Gen. Stephen R. Lyons**, commander of U.S. Transportation Command, during a change of command ceremony June 23 at Scott Air Force Base, Illinois. With a surface warrior workforce of over 5,000 transportation professionals and nine total force transportation brigades located throughout the world, SDDC moves, deploys and sustains the armed forces to deliver readiness and lethality at speed. (Photo by Laura Marshall, SDDC)

PROGRAM EXECUTIVE OFFICE FOR COMBAT SUPPORT AND COMBAT SERVICE SUPPORT

2: RETIREMENT CAPS 30-YEAR CAREER

Attendees gathered virtually June 18 to honor **Col. Shane Fullmer**, chief of staff in the Program Executive Office for Combat Support and Combat Service Support (PEO CS&CSS), on his retirement from active duty. The ceremony was hosted by **Timothy G. Goddette**, program executive of-

ficer for CS&CSS, who recognized Fullmer for his 30 years of service. Fullmer, who led the Joint Light Tactical Vehicle Program Office, was awarded the Legion of Merit in honor of his achievements. (Photos by Rae Higgins, PEO CS&CSS)

3: PME2S2 HOLDS CHANGE OF CHARTER

Timothy G. Goddette, program executive officer for CS&CSS, presided over a June 9 virtual ceremony during which **Col. Adrian Marsh** relinquished the charter of Project Manager Expeditionary Energy and Sustainment Systems (PM E2S2) to **Col. Kathy Brown**. Brown and her family greeted attendees of the virtual event, and Marsh's wife, **Denise Marsh**, presented him the Legion of Merit for his three-year tenure as project manager.

Brown joins PEO CS&CSS from the Office of the Secretary of Defense, where she was assigned in the International Armaments Cooperation Directorate as Country Director for Canada, South Korea and Latin America. Marsh now serves in the Office of the Secretary of Defense. PM E2S2 is a diverse organization touching every echelon of the Army's combat support system. The power generation and force sustainment systems its acquisition professionals manage greatly expand warfighter capability. (Photos by Tomas Ortiz, PEO CS&CSS)



3

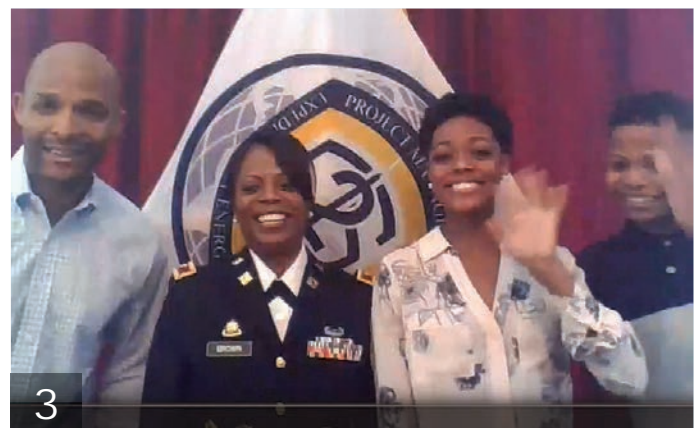

3

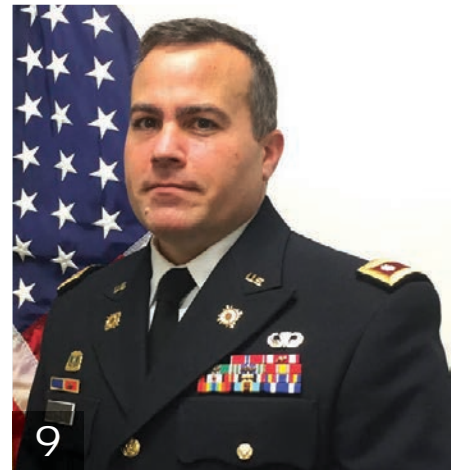
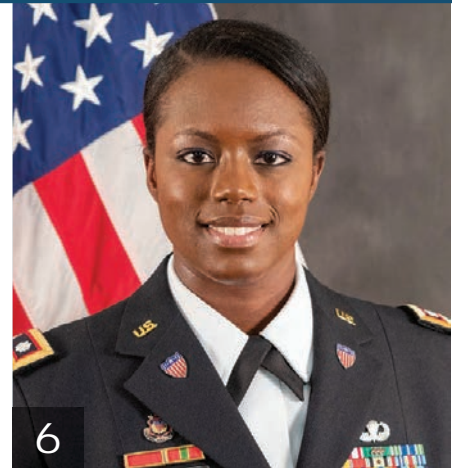
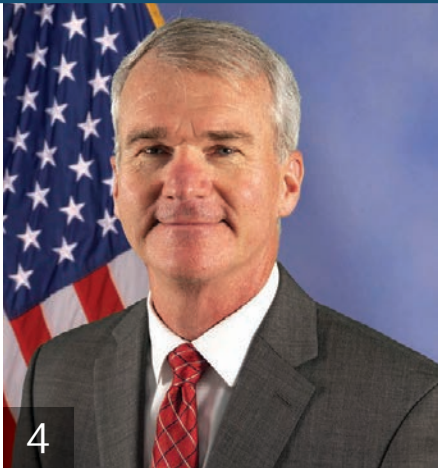

PROGRAM EXECUTIVE OFFICE FOR ENTERPRISE INFORMATION SYSTEMS

4: NEW ASSISTANT PEO, BUSINESS MISSION AREA

Dan Joyce assumed the position of assistant program executive officer (APEO), Business Mission Area on June 22, taking over for **Col. Wayne Barker**, who departed the Program Executive Office for Enterprise Information Systems (PEO EIS) to become chief of staff in the Office of the Assistant Secretary of the Army for Acquisition, Logistics and Technology. Joyce previously served as APEO for Network, Cyber and Services.

5: CHANGE OF CHARTER AT ACT

Lt. Col. Peter Amara assumed responsibility as the Applied Cyber Technologies product lead from retiring product lead **Joseph Kobsar** on May 28 at a virtual change of charter ceremony hosted by **Col. Chad Harris**, project manager for PEO EIS's Defensive Cyber Operations (DCO). Previously, Amara served as assistant product manager for user-activity monitoring, part of DCO's Cyber Analytics and Detection.

6: NEW PM AT ACWS

Lt. Col. Christee Cuttino assumed responsibility as product manager of PEO EIS's Army Contract Writing System from **Lt. Col. Christopher Center** at a virtual change of charter ceremony on June 30. Cuttino previously served as a Department of the Army systems coordinator with a concentration in areas relating to Future Long Range Assault Aircraft and Future Attack Reconnaissance Aircraft.

7: CHANGE OF CHARTER AT ALTESS

Boyd Williams assumed the role of product director of PEO EIS's Acquisition, Logistics and Technology Enterprise Systems & Services (ALT-ESS) from **Timothy Hale** at a change of charter ceremony in Radford, Virginia, on July 9. Williams previously served as deputy product director for ALTESS.

8: LEADERSHIP CHANGE AT IPPS-A OFFICE

Lt. Col. Corris Bullock assumed the role of product manager of PEO EIS's Integrated Personnel and Pay System – Army Increment II (IPPS-A Inc II) from **Lt. Col. Laverne Amara** at a virtual change of charter ceremony on June 10. Bullock comes to IPPS-A from the Pentagon, where he was the executive officer to the deputy for acquisition and system management.

9: WESS WELCOMES NEW PM

Lt. Col. Scott Davis assumed responsibility as product manager of PEO EIS's Wideband Enterprise Satellite Systems (WESS) from **Lt. Col. Anthony Whitfield** at a virtual change of charter ceremony on June 26. Davis previously was assigned as the executive officer to the deputy assistant secretary of the Army for plans, programs and resources.



1



2



3



4

PROGRAM EXECUTIVE OFFICE FOR MISSILES AND SPACE

1: PROMOTION AND CHARTER ASSUMPTION

Col. Jason Tate was honored during his June 8 promotion ceremony, hosted by **Larry Muzzelo**, deputy to the commanding general of U.S. Army Communications-Electronics Command, at the command's headquarters on Aberdeen Proving Ground, Maryland. Tate was joined by his wife, Dr. Kandie Tate, and sons Noah, Nathan and Nicholas. Tate assumed the charter of Project Manager, Search, Track, Acquire, Radiate, Eliminate (STARE) on July 10 in the Program Executive Office for Missiles and Space (PEO MS). (Photo by the Product Manager for Multi-Mission Surveillance Systems)

2: LEADERSHIP CHANGE IN LOWER TIER OFFICE

The Lower Tier Project Office hosted a change of charter ceremony for the Lower Tier Air and Missile Defense Sensor Product Manager on May 5 at Redstone Arsenal, Alabama. **Col. Francisco Lozano**, center, project manager for the Lower Tier Project Office, officiated the ceremony for the outgoing product manager, **Lt. Col. Roland Matthews**, right, and incoming product manager, **Lt. Col. Sean Green**, left. (Photo courtesy of PEO MS)

3: PATRIOT GROUND SUPPORT EQUIPMENT CHANGE OF CHARTER

Col. Francisco Lozano, center, project manager for the Lower Tier Project Office, conducted a change of charter ceremony for the PATRIOT Ground Support Equipment Product Office for **Stephen M. Roberts**, left, the outgoing product manager, and incoming Product Manager **George J. Mitchell**, right. (Photo by Henry Norton, PEO MS)

4: NEW PRODUCT MANAGER FOR IFMC HARDWARE

Col. Philip Rottenborn, left, project manager for the Integrated Fires Mission Command (IFMC) Project Office, hosted a live-streamed change of charter ceremony on July 17 for the IFMC Hardware Product Office. The event welcomed the incoming product manager **Lt. Col. Ernesto Perez**, right, and honored outgoing product manager **Lt. Col. Cassandra Forrester**. Forrester departed PEO MS after three years with the IFMC Engagement Operations Centers and Integrated Air and Missile Defense Hardware. Perez comes to the IFMC Project Office from an assignment in Japan. (Photo by Henry Norton, PEO MS)

5: PGMR CHANGE OF CHARTER

Lt. Col. Marvin Millar, left, outgoing Precision Guided Munitions and Rockets (PGMR) product manager; **Lt. Col. Demond Merrick**, center, incoming PGMR product manager; and **Col. Guy Yelverton III**, right, Strategic and Operational Rockets and Missiles (STORM) project manager, participated in a change of charter ceremony on June 16 at Redstone Arsenal.

Yelverton officiated the ceremony, which was live-streamed because of strict limits on attendance. He and the team honored Millar for his service and welcomed Merrick to the PGMR team. (Photo by STORM Project Office)

6: IAMD SOFTWARE WELCOMES NEW LEADER

Col. Philip Rottenborn, left, project manager for the Integrated Air and Missile Defense (IAMD) Project Office hosted a change of charter ceremony for the IAMD Software Product Office on June 12, welcoming incoming Product Manager **Lt. Col. Chad B. Watts**, right, and honoring the outgoing project manager, **Lt. Col. Adam M. Miller**. (Photo by Henry Norton, PEO MS)

7: LEADERSHIP CHANGE AT PRSM

The Strategic and Operational Rockets and Missiles (STORM) Project Office hosted a change of charter ceremony for the Precision Strike Missile (PRSM) Product Director on May 21 at Redstone Arsenal. **Col. Guy Yelverton III**, STORM project manager, officiated the ceremony for

the outgoing PRSM product director, **Michael D. Wills**, left, and the incoming product director, **Craig A. Bergquist**, right. The event was live-streamed as in-person attendance was strictly limited. Yelverton and the team wish Wills well in his new role at the Missile Defense Agency and welcome Bergquist to the Precision Strike Missile team at STORM. (Photo by STORM Project Office)

8: RETIREMENT CAPS 23 YEAR CAREER

Maj. Gen. Robert A. Rasch, left, program executive officer for Missiles and Space, hosted a virtual retirement ceremony on June 18 in honor of **Lt. Col. Roland L. Matthews**, right, for his 23 years of service. (Photo by Henry Norton, PEO MS)

ARMY OFFICER ASSIGNMENTS

Army Chief of Staff Gen. James C. McConville announced the following officer assignments:

Lt. Gen. David G. Bassett, currently serving as director, Defense Contract Management Agency, Fort Lee, Virginia.

Lt. Gen. Thomas H. Todd III, currently serving as deputy commanding general, Acquisition and Systems Management, U.S. Army Futures Command, Austin, Texas.

Brig. Gen. Ronald R. Ragin, currently serving as commanding general, 13th Expeditionary Sustainment Command, Fort Hood, Texas.





HELLO HELOS

In 1961, in the heat of the Cold War, the U.S. Army's view of materiel for transport—air or ground—wasn't that different from today: The best tech wins.

Among the Army's top priorities today are future vehicles for both land and air. Whatever the fruits of the Next Generation Combat Vehicle and Future Vertical Lift programs look like, it is probably a safe bet that they won't look anything like the futuristic vehicle highlighted in the January 1961—only the second—edition of Army Research and Development Newsmagazine, the predecessor to this publication.

On page 8, we learn about DOD's research into "ground effects machines." At the time, all of the services were keenly interested in the possibilities inherent in hovercraft. In the late 1950s, the Curtiss-Wright Corp. introduced its Model 2500 Air Car, which sought to shake up the American automobile market with a family-car equivalent hovercraft. Reflecting the "tremendous interest" in what DOD was calling "ground effects," or (apparently)

hovering, the U.S. Army Transportation Corps acquired a pair of the machines, which were powered by two aircraft engines driving ducted fans.

The car rose off flat ground—or water—on a cushion of air and a surrounding dust or vapor cloud, and allegedly traveled as fast as 60 miles per hour. The vehicle steered with louvered vents in its sides that could push it right or left, though it's not hard to imagine a driver losing control of the contraption at higher speeds. It did less well on rougher terrain. Perhaps coincidentally, the design of the Curtiss-Wright vehicle seems to share a good deal with bumper cars.

The vehicle didn't gain much traction with the American public, nor with the U.S. Army, which was also working on, among other things, a different sort of hovercraft—the

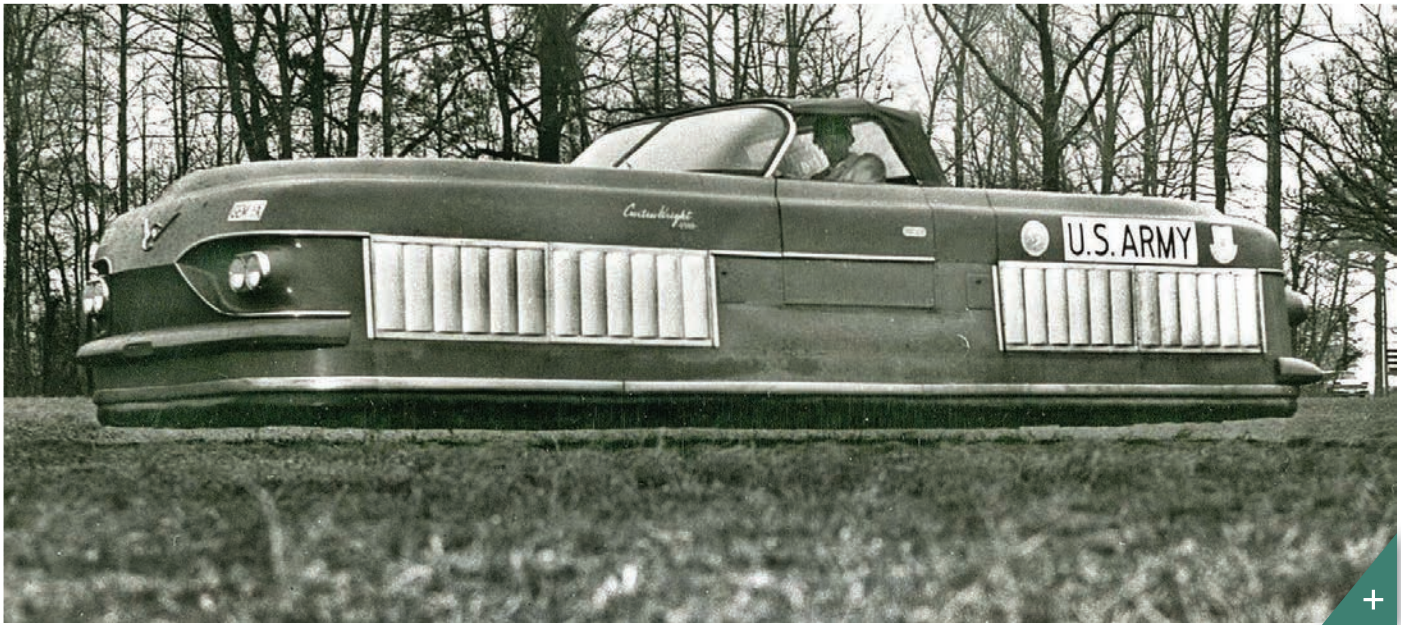

WHAT A GEM

The U.S. Army ground effects machine, or GEM, was a hovercraft powered by two aircraft engines driving ducted fans and was capable of traveling over land or water—even if it may have been a little hard to steer. (Photo courtesy of the U.S. Army Transportation Museum, Fort Eustis, Virginia)

helicopter. That technology had been kicking around nearly as long as the airplane, if you don't count Leonardo da Vinci's conceptual drawings.

LUMBERING BEAST

But the Army, then as now, had more irons in the fire than just the ground-effects machine. Two pages later, we learn that the Army was also looking into using a nuclear reactor to power its Overland Train.

To the contemporary eye, the Overland Train might seem as wacky as the Air Car. The magazine's accompanying image, of what appears to be a truck pulling trailer after trailer, seems almost patently absurd. But that image offers no sense of the scale of the machine. That may have been because the Overland Train was probably well-known to readers. Indeed,

it was something of a midcentury engineering marvel that had even appeared in LIFE Magazine.

R.G. LeTourneau Inc., a Texas maker of heavy machinery, created the Tournatrain to haul timber from remote wilderness areas where there were no roads and no infrastructure. The Army wanted to do the exact opposite—haul tons of gear into wilderness where there was essentially nothing. This was in service to the DEW line. DEW was an acronym for distant early warning. If the Soviets launched a nuclear attack against the United States, the shortest distance for their bombers to travel would be over the North Pole.

If the United States wanted an early warning of such an attack and the ability to strike back with its own bombers and intercontinental ballistic missiles, it

needed to move many hundreds of tons of gear and infrastructure to the inside the Arctic Circle. Creating the DEW line meant that the government needed to have sensors where there had never been any.

Back at the beginning of 1961, it wasn't yet three years since the U.S. had launched its first artificial satellite, much less a GPS network. So the country needed boots on the ground along with radar stations in remote locations to monitor for potential nuclear surprise attacks. The DEW line was also intended to warn of invasion by sea and land.

That meant that the Army needed a means to haul all of that materiel to places with no roads or infrastructure and nothing but wilderness. When the U.S. Army Transportation Research and Development Command (TRADCOM) got a



MEANT FOR BIG JOBS

LeTourneau's TC-497 Overland Train Mark II boasted a three-story tall, six-wheeled cab and 10-foot-tall tires. (Source: Wikipedia)

demonstration of LeTourneau's VC-12 Tournatrain, the logging version of the trainlike truck, it probably seemed like the Army's best bet.

MONSTER TRUCKS

Based on a diesel locomotive, LeTourneau's overland train was powered by a 500-horsepower diesel engine that didn't drive the wheels, but powered a generator to provide electricity to each hub, which had its own motor. The Army never bought

the VC-12, but TRADCOM funded the development of another LeTourneau vehicle, the TC-264 Sno-Buggy, a vehicle that resembles the lovechild of a semi-truck tractor and a farm tractor: two wheels in front and eight in back, paired in twos, and with 10-foot-tall tires. It had a monster footprint—a sufficient tire-to-vehicle-weight area to enable it to move across tundra and snow. It was powered by the same engine that powered the Lockheed P-38 and many other World War II

aircraft. Meanwhile, LeTourneau was also developing the VC-22 Sno-Freighter for Alaska Freightlines and the Army. Both were working with Canada on the development of the DEW line.

The Army was aiming for more. The Army Transportation Corps asked LeTourneau to combine the Sno-Buggy with the Tournatrain, which resulted in a vehicle that the Army called the Logistics Cargo Carrier (LCC 1), of which it took possession in the

The Army wanted to do the exact opposite—haul tons of gear into wilderness where there was essentially nothing.

mid-1950s. Capable of hauling 45 tons, the vehicle was successful enough that the Army wanted one that was bigger and better—an overland train that could be as long as the Army needed it to be.

LCC 1's successor, the eventual Overland Train, was a monster version of the LCC 1. LeTourneau's TC-497 Overland Train Mark II boasted a three-story tall, six-wheeled cab—in images, it's reminiscent of an air traffic control tower—and also had 10-foot-tall tires. It could haul 150 tons, measured nearly three football fields in length, and could travel about 400 miles at about 20 miles per hour.

The idea for a nuclear powerplant for the vehicle in 1961 made sense: The vehicle was enormous and adding more power would enable endless expansion. A nuclear power plant could generate power for the electric motors that drove each of the wheels indefinitely.

By that time, the Army had been looking at small-scale nuclear power plants, and the idea of nuclear power may have been part of

a larger strategy. In the May 1961 issue, Lt. Gen. Arthur Trudeau, then the Army chief of research and development, noted that “Unfortunately, the extent to which nuclear plants can be miniaturized appears to be limited—and the cost of reactors is still too high. Yet, we can approach the optimum if we utilize a nuclear-powered, cross-country vehicle comparable to the overland train as a mobile supply point. (See Army R&D Newsmagazine, January, Page 10.)”

VERTICAL LIFT TAKES OFF

Alas, it was not to be. LeTourneau delivered the final version, with gas turbine engines, to the Army at Yuma Proving Ground, Arizona, where it stayed. According to online sources, the cab is still there. The rest was sold off.

As to its predecessor, according to an article in the UK's Daily Mail, “The Sno-Buggy's massive tires were later used on the famous Bigfoot monster truck, after the owner bought them in a Seattle junkyard for \$1,000.”

The thing that killed the overland train wasn't any failure of the Army, the vehicle or LeTourneau, which is now part of Komatsu LTD. It was the Army's simultaneous work in vertical lift. The Sikorsky CH-54 Tarhe twin-engine heavy-life helicopter could do the job that the Overland Train was intended to do, but could do it better, cheaper and faster. Its civilian counterpart, the S-64 Skycrane, first flew in 1962.

—STEVE STARK



THE BIGGEST WHEEL

A LeTourneau LCC-1 Sno-Train carrying supplies near Camp Century, an Arctic United States military scientific research base in Greenland, June 1959. The base is a network of trenches dug out of the snow and ice and lined with corrugated steel arches. Camp Century was later found to be a cover project for Project Iceworm, a secret plan to install nuclear missile launch sites under the Greenland ice sheet. Both Camp Century and Project Iceworm were abandoned in 1967 when it emerged that the Greenland ice was not stable enough for the structures to be viable in the long term. (Photo by U.S. Army/Pictorial Parade/Archive Photos/Getty Images)

ARMY ACQUISITION, LOGISTICS & TECHNOLOGY
ISSN 0892-8657

DEPARTMENT OF THE ARMY
ARMY AL&T
9900 BELVOIR RD
FORT BELVOIR, VA 22060-5567

ASC.ARMY.MIL

HEADQUARTERS DEPARTMENT OF THE ARMY | PB 70-20-04 | APPROVED FOR PUBLIC RELEASE: DISTRIBUTION IS UNLIMITED

“For most people, the U.S. Army doesn’t come readily to mind when they think about the national response to the COVID-19 pandemic. Still, the Army—and the acquisition community in particular—have a critically important role.”

Dr. Bruce D. Jette
Army Acquisition Executive
Page 4



PUBLISHED BY



PIN: 207169-000